



AC15 Series

Variable Speed Drive

Software Reference Manual

DOC-0017-05-EN-B
04.04.2023



ENGINEERING **YOUR** SUCCESS.

1 Safety

IMPORTANT: Please read this information BEFORE installing the equipment.

1.1 Intended Users

This manual is to be made available to all persons who are required to install, configure or service equipment described herein, or any other associated operation.

The information given is intended to highlight safety issues, and to enable the user to obtain maximum benefit from the equipment.

Complete the following table for future reference detailing how the unit is to be installed and used.

INSTALLATION DETAILS	
Model Number (see product label)	
Where installed (for information)	

1.2 Application Area





The equipment described is intended for industrial motor speed control utilizing AC induction motors or AC permanent magnet synchronous machines.

1.3 Personnel

Installation, operation and maintenance of the equipment should be carried out by competent personnel. A competent person is someone who is technically qualified and familiar with all safety information and established safety practices; with the installation process, operation and maintenance of this equipment; and with all the hazards involved.

1.4 Product Warnings

Special attention must be paid to the information presented in warning, caution and information notices when they appear in this manual. Definitions of caution, warning and information notices are shown below:

 DANGER Risk of electric shock	 WARNING Hot surfaces	 Caution Refer to documentation	 Earth/Ground Protective Conductor Terminal
---	--	--	--

Application Risk

The specifications, processes and circuitry described herein are for guidance only and may need to be adapted to the user's specific application. We cannot guarantee the suitability of the equipment described in this Manual for individual applications.

Risk Assessment

Under fault conditions, power loss or unintended operating conditions, the drive may not operate as intended. In particular:

- Stored energy might not discharge to safe levels as quickly as suggested and can still be present even though the drive appears to be switched off.
- The motor's direction of rotation might not be controlled
- The motor speed might not be controlled
- The motor might be energised

A drive is a component within a drive system that may influence its operation or effects under a fault condition. Consideration must be given to:

- Stored energy
- Supply disconnects
- Sequencing logic
- Unintended operation

1.5 Safety Information

Risk of Electric Shock

DANGER!



Ignoring the following may result in injury:

- This equipment can endanger life by exposure to rotating machinery and high voltages.
- The equipment must be permanently earthed due to the high earth leakage current, and the inverter motor must be connected to an appropriate safety earth.
- Ensure all incoming supplies are isolated before working on the equipment. Be aware that there may be more than one supply connection to the inverter.
- There may still be dangerous voltages present at power terminals (motor output, supply input phases, DC bus and the brake, where fitted) when the motor is at standstill or is stopped.
- For measurements use only a meter to IEC 61010 (CAT III or higher). Always begin using the highest range. CAT I and CAT II meters must not be used on this product.
- Allow at least 10 minutes for the inverter's capacitors to discharge to safe voltage levels (<50V). Use the specified meter capable of measuring up to 1000V dc & ac rms to confirm that less than 50V is present between all power terminals and between power terminals and earth.
- Unless otherwise stated, this product must NOT be dismantled. In the event of a fault the inverter must be returned. Refer to "Routine Maintenance and Repair".



Safety & EMC Requirements

Where there is a conflict between safety and EMC requirements, personnel safety shall always take precedence.



WARNING!

Ignoring the following may result in injury or damage to equipment:



- Never perform high voltage resistance checks on the wiring without first disconnecting the inverter from the circuit being tested.
- Whilst ensuring ventilation is sufficient, provide guarding and /or additional safety systems to prevent injury or damage to equipment.
- When replacing an inverter in an application and before returning to use, it is essential that all user defined parameters for the product's operation are correctly installed.
- When replacing an inverter in an application and before returning to use, it is essential that all user defined parameters for the product's operation are correctly installed.
- All control and signal terminals are SELV, i.e. protected by double insulation. Ensure all external wiring is rated for the highest system voltage.
- Thermal sensors contained within the motor must have at least basic insulation.
- All exposed metalwork in the Inverter is protected by basic insulation and bonded to a safety earth.
- RCDs are not recommended for use with this product but, where their use is mandatory, only Type B RCDs should be used.



WARNING!

Ignoring the following may result in injury or damage to equipment:



- In a domestic environment this product may cause radio interference in which case supplementary mitigation measures may be required.
- This equipment contains electrostatic discharge (ESD) sensitive parts. Observe static control precautions when handling, installing and servicing this product.
- This is a product of the restricted sales distribution class according to IEC 61800-3. It is designated as "professional equipment" as defined in EN61000-3-2 for AC15: Frame sizes 1 (all), 2 (3 ϕ products only) & 3 (400V products only). Permission of the supply authority shall be obtained before connection to the public low voltage supply. For all other Frame sizes not specified above, connection to the public LV supply must be agreed case by case between manufacturer, installer or user and distribution network operator.

2 Manufacturing Location

Germany

Parker Hannifin Manufacturing Germany GmbH & Co. KG

Electric Motion & Pneumatic Division (EMPD)

Robert-Bosch-Strasse 22

77656 Offenburg (Germany)

Tel.: + 49 (0781) 509-0

Website: www.parker.com/eme

Certified according to ISO 9001:2015

Parker Hannifin Manufacturing Germany GmbH & Co. KG - Sitz: Bielefeld - Amtsgericht: Bielefeld HRA 15699
persönlich haftende Gesellschafterin: Parker Hannifin GmbH - Sitz: Bielefeld - Amtsgericht Bielefeld HRB 35489
Geschäftsführung der Parker Hannifin GmbH: Ulrich Jochem, Achim Kohler, Andreas Paulsen, Kirsten Stenvers
Vorsitzender des Aufsichtsrates: Dr.-Ing. Gerd Scheffel

3 Waste Electrical and Electronic Equipment (WEEE)



Waste Electrical and Electronic Equipment - must not be disposed of with domestic waste. It must be separately collected according to local legislation and applicable laws.



Parker Hannifin Company, together with local distributors and in accordance with EU directive 2002/96/EC, undertakes to withdraw and dispose of its products, fully respecting environmental considerations. For more information about how to recycle your Parker supplied waste equipment, please contact your local Parker Service Centre.

Packaging

During transport our products are protected by suitable packaging. This should be taken for central disposal as secondary raw material.

4 Table of Contents

1	Safety	2
1.1	Intended Users.....	2
1.2	Application Area.....	2
1.3	Personnel.....	2
1.4	Product Warnings.....	2
1.5	Safety Information.....	3
2	Manufacturing Location	5
3	Waste Electrical and Electronic Equipment (WEEE)	6
4	Table of Contents	7
5	Introduction	9
5.1	Users.....	9
5.2	Manual Organisation.....	9
5.3	Manual Revision.....	9
6	User Display Keypads	10
6.1	AC15 Built In Keypad.....	10
6.2	6901 Remote MMI.....	11
7	Keypad Menu	13
7.1	The Menu System.....	13
7.2	Navigating the Menu.....	13
7.3	Changing the View Level.....	14
7.4	Saving Parameter Changes.....	15
7.5	Resetting to Factory Defaults.....	16
7.6	Updating Firmware.....	16
7.7	AC15 Menu Structure.....	17
8	Communications	34
8.1	Connecting to the Inverter.....	34
8.2	Connecting to DSE Lite.....	35
8.3	Manual Ethernet Configuration.....	37
8.4	Troubleshooting.....	38
8.5	Connecting to the Webserver.....	40
9	Programming Your Application	42
9.1	Macros.....	42
9.2	Programming with Block Diagrams.....	42
9.3	Programming Rules.....	43
9.4	Execution Rules.....	43
9.5	Saving Your Modifications.....	43
9.6	Understanding the Function block Description.....	44
9.7	Function Blocks in Alphabetical Order.....	45

10	Inverter State Machine	186
10.1	DS402	186
10.2	Sequencing State	186
10.3	Sequencing Diagram	187
10.4	State Transitions	188
10.5	Control Word	189
10.6	Status Word	190
11	Trips & Fault Finding	191
11.1	What Happens When a Trip Occurs?	191
11.2	Display/Keypad Indication	191
11.3	Resetting a Trip Condition	191
11.4	Trip and Warning Messages	191
11.5	Alerts	196
11.6	Autotune Alerts	197
12	Fire Mode	198
12.1	Introduction	198
12.2	Sequencing	198
12.3	Reference	199
13	Fieldbuses	200
13.1	Modbus TCP/IP	200
13.2	EtherNet/IP	205
APPENDIX A: Data types		211
APPENDIX B: Encoder Functions		212
APPENDIX C: Parameters – Tag Number Order		214
APPENDIX D: Application Macros		249
13.3	Overview	249
13.4	Standard (Basic Speed Control)	251
13.5	Auto / Manual	253
13.6	Presets	255
13.7	Raise/Lower	257
13.8	PID	259
13.9	Aux Comms	261

5 Introduction

5.1 Users

This Manual is intended for use by both users and programmers of AC15 series inverters. It assumes a reasonable level of understanding of both inverter use and application programming.

Installation and basic setup are covered in a separate manual, DOC-0017-03 'AC15 Series Hardware Installation Manual: Frames 1-5' that is intended for use by the installer of the drive.

Note: It is important to always pass on this Manual to any new user.

5.2 Manual Organisation

This Software Reference Manual is organised into chapters, indicated by the numbering on the edge of each page.

If the manual is to be printed, it is designed so that it should be printed double-sided using the long-edge for binding.







Information for the AC15 product may be referred to as “the Inverter” or “drive” throughout the manual.

5.3 Manual Revision







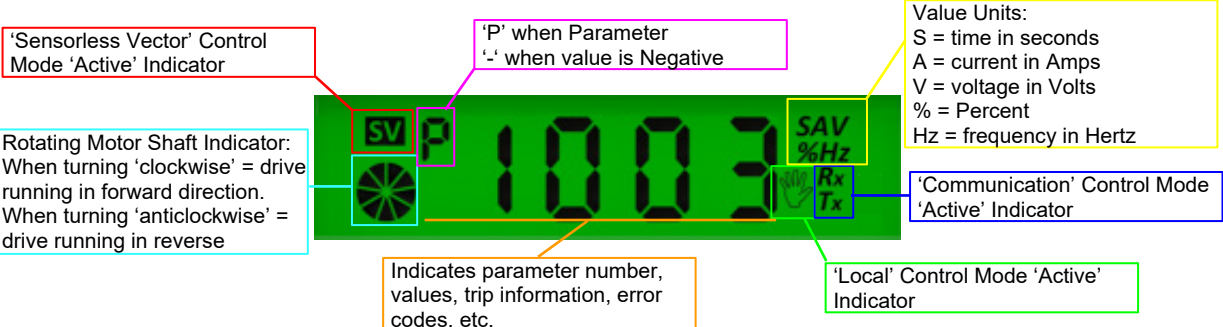

This revision replaces all previous revisions of this document. Parker has made every effort to ensure that this document is complete and accurate at the time of printing. In accordance with our policy of continuous product improvement, all data in this document is subject to change or correction without prior notice.





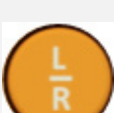

6 User Display Keypads

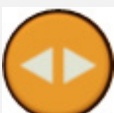
6.1 AC15 Built In Keypad

Keypad Overview	
	
Navigation / Parameter Edit Keys	
	<p>MENU Key Navigation - Displays the next Menu level, or the first parameter of the current Menu. Parameter - Allows a writable parameter to be modified</p>
	<p>UP Key Navigation - Moves upwards through the list of parameters. Parameter - Increments the value of the displayed parameter. Press at the same time as STOP key to select forward direction when in Local mode</p>
	<p>DOWN Key Navigation - Moves downwards through the list of parameters. Parameter - Decrements the value of the displayed parameter. Press at the same time as STOP key to select reverse direction when in Local mode</p>
	<p>ESCAPE Key Navigation - Displays the previous level's Menu. Parameter - Returns to the parameter list. Trip Acknowledge - Acknowledges displayed Trip or Error message.</p>
Local Mode Operating Keys	
	<p>RUN Key Control - Runs the motor at a speed determined by the LOCAL SETPOINT. Trip Reset - Resets any trips and then runs the motor as above. Only operates when the Inverter is in Local Start/Stop (Seq) mode.</p>
	<p>STOP / RESET Key Control - Stops the motor. Only operates when the Inverter is in Local Sequence mode. Trip Reset - Resets any trips and clears displayed message if trip is no longer active. Press and hold for approx. 3 seconds to toggle between Local and Remote modes of operation Press at the same time as UP or DOWN key to reverse direction when in Local mode</p>
Display	
	

6.2 6901 Remote MMI

6901 Keypad Overview	
	
Navigation / Parameter Edit Keys	
	<p>UP Key</p> <p>Navigation - Moves upwards through the list of parameters. Parameter - Increments the value of the displayed parameter.</p>
	<p>DOWN Key</p> <p>Navigation - Moves downwards through the list of parameters. Parameter - Decrements the value of the displayed parameter.</p>
	<p>ESCAPE Key</p> <p>Navigation - Displays the previous level's Menu. Parameter - Returns to the parameter list. Trip Acknowledge - Acknowledges displayed Trip or Error message.</p>
	<p>MENU Key</p> <p>Navigation - Displays the next Menu level, or the first parameter of the current Menu. Parameter - Allows a writable parameter to be modified (this is indicated by → appearing on the left of the bottom line).</p>
	<p>PROGRAM Key</p> <p>No Function.</p>
	<p>LOCAL / REMOTE Mode Select Key</p> <p>Control - Toggles between Remote and Local Control for both Start/Stop (Seq) and Speed Control (Ref). When toggling, the display automatically goes to the relevant SETPOINT screen, and the SETPOINT (LOCAL) screen will have the ▲ and ▼ keys enabled to alter the setpoint.</p>
Local Mode Operating Keys	
	<p>RUN Key</p> <p>Control - Runs the motor at a speed determined by the LOCAL SETPOINT. Trip Reset - Resets any trips and then runs the motor as above. Only operates when the Inverter is in Local Start/Stop (Seq) mode.</p>
	<p>DIRECTION Key</p> <p>Control - Changes the direction of motor rotation. Only operates when the Inverter is in Local Speed Control mode.</p>

	<p>JOG Key Control - Runs the motor at a speed determined by the JOG SETPOINT parameter. When the key is released, the Inverter returns to the "STOPPED" state. Only operates when the inverter is "STOPPED", and in Local Start/Stop mode.</p>																																								
	<p>STOP / RESET Key Control - Stops the motor. Only operates when the Inverter is in Local Sequence mode. Trip Reset - Resets any trips and clears displayed message if trip is no longer active.</p>																																								
Status Indicator LEDs																																									
	<table border="1"> <thead> <tr> <th>'SEQ' LED</th> <th>'REF' LED</th> <th>Inverter Status</th> </tr> </thead> <tbody> <tr> <td style="text-align: center;">○</td> <td style="text-align: center;">○</td> <td>Start/Stop (Seq) and Speed Control (Ref) are controlled from the inverter terminals.</td> </tr> <tr> <td style="text-align: center;">●</td> <td style="text-align: center;">○</td> <td>Start/Stop (Seq) is controlled using the RUN, STOP, JOG and FWD/REV keys. Speed Control (Ref) is controlled from the inverter terminals.</td> </tr> <tr> <td style="text-align: center;">○</td> <td style="text-align: center;">●</td> <td>Start/Stop (Seq) is controlled from the terminals</td> </tr> <tr> <td style="text-align: center;">●</td> <td style="text-align: center;">●</td> <td>Speed Control (Ref) is controlled using the up (▲) and down (▼) keys</td> </tr> </tbody> </table>	'SEQ' LED	'REF' LED	Inverter Status	○	○	Start/Stop (Seq) and Speed Control (Ref) are controlled from the inverter terminals.	●	○	Start/Stop (Seq) is controlled using the RUN, STOP, JOG and FWD/REV keys. Speed Control (Ref) is controlled from the inverter terminals.	○	●	Start/Stop (Seq) is controlled from the terminals	●	●	Speed Control (Ref) is controlled using the up (▲) and down (▼) keys																									
'SEQ' LED	'REF' LED	Inverter Status																																							
○	○	Start/Stop (Seq) and Speed Control (Ref) are controlled from the inverter terminals.																																							
●	○	Start/Stop (Seq) is controlled using the RUN, STOP, JOG and FWD/REV keys. Speed Control (Ref) is controlled from the inverter terminals.																																							
○	●	Start/Stop (Seq) is controlled from the terminals																																							
●	●	Speed Control (Ref) is controlled using the up (▲) and down (▼) keys																																							
  	<table border="1"> <thead> <tr> <th>'OK' LED (HEALTH)</th> <th>'I' LED (RUN)</th> <th>'O' LED (STOP)</th> <th>Inverter Status</th> </tr> </thead> <tbody> <tr> <td style="text-align: center;">◐</td> <td style="text-align: center;">◐</td> <td style="text-align: center;">◐</td> <td>Inverter in CONFIGURATION mode.</td> </tr> <tr> <td style="text-align: center;">◐</td> <td style="text-align: center;">○</td> <td style="text-align: center;">●</td> <td>Inverter TRIPPED.</td> </tr> <tr> <td style="text-align: center;">●</td> <td style="text-align: center;">○</td> <td style="text-align: center;">●</td> <td>Inverter STOPPED.</td> </tr> <tr> <td style="text-align: center;">●</td> <td style="text-align: center;">○</td> <td style="text-align: center;">◐</td> <td>Inverter STOPPING.</td> </tr> <tr> <td style="text-align: center;">●</td> <td style="text-align: center;">◐</td> <td style="text-align: center;">○</td> <td>Inverter RUNNING with ZERO SPEED demand or enable false or contactor feedback false.</td> </tr> <tr> <td style="text-align: center;">●</td> <td style="text-align: center;">●</td> <td style="text-align: center;">○</td> <td>Inverter RUNNING.</td> </tr> <tr> <td style="text-align: center;">●</td> <td style="text-align: center;">○</td> <td style="text-align: center;">◐</td> <td>Inverter performing an AUTOTUNE routine.</td> </tr> <tr> <td style="text-align: center;">◐</td> <td style="text-align: center;">○</td> <td style="text-align: center;">●</td> <td>Inverter awaiting AUTO RESTARTING, waiting for TRIP cause to clear.</td> </tr> <tr> <td style="text-align: center;">◐</td> <td style="text-align: center;">○</td> <td style="text-align: center;">○</td> <td>Inverter AUTO RESTARTING</td> </tr> </tbody> </table>	'OK' LED (HEALTH)	'I' LED (RUN)	'O' LED (STOP)	Inverter Status	◐	◐	◐	Inverter in CONFIGURATION mode.	◐	○	●	Inverter TRIPPED.	●	○	●	Inverter STOPPED.	●	○	◐	Inverter STOPPING.	●	◐	○	Inverter RUNNING with ZERO SPEED demand or enable false or contactor feedback false.	●	●	○	Inverter RUNNING.	●	○	◐	Inverter performing an AUTOTUNE routine.	◐	○	●	Inverter awaiting AUTO RESTARTING, waiting for TRIP cause to clear.	◐	○	○	Inverter AUTO RESTARTING
'OK' LED (HEALTH)	'I' LED (RUN)	'O' LED (STOP)	Inverter Status																																						
◐	◐	◐	Inverter in CONFIGURATION mode.																																						
◐	○	●	Inverter TRIPPED.																																						
●	○	●	Inverter STOPPED.																																						
●	○	◐	Inverter STOPPING.																																						
●	◐	○	Inverter RUNNING with ZERO SPEED demand or enable false or contactor feedback false.																																						
●	●	○	Inverter RUNNING.																																						
●	○	◐	Inverter performing an AUTOTUNE routine.																																						
◐	○	●	Inverter awaiting AUTO RESTARTING, waiting for TRIP cause to clear.																																						
◐	○	○	Inverter AUTO RESTARTING																																						
	<table border="1"> <thead> <tr> <th>'◀' LED (REV)</th> <th>'▶' LED (FWD)</th> <th>Inverter Status</th> </tr> </thead> <tbody> <tr> <td style="text-align: center;">○</td> <td style="text-align: center;">●</td> <td>Inverter RUNNING. Requested direction and actual direction are forward.</td> </tr> <tr> <td style="text-align: center;">●</td> <td style="text-align: center;">○</td> <td>Inverter RUNNING. Requested direction and actual direction are reverse.</td> </tr> <tr> <td style="text-align: center;">○</td> <td style="text-align: center;">◐</td> <td>Inverter RUNNING. Requested direction is forward but actual direction is reverse.</td> </tr> <tr> <td style="text-align: center;">◐</td> <td style="text-align: center;">○</td> <td>Inverter RUNNING. Requested direction is reverse but actual direction is forward.</td> </tr> </tbody> </table>	'◀' LED (REV)	'▶' LED (FWD)	Inverter Status	○	●	Inverter RUNNING. Requested direction and actual direction are forward.	●	○	Inverter RUNNING. Requested direction and actual direction are reverse.	○	◐	Inverter RUNNING. Requested direction is forward but actual direction is reverse.	◐	○	Inverter RUNNING. Requested direction is reverse but actual direction is forward.																									
'◀' LED (REV)	'▶' LED (FWD)	Inverter Status																																							
○	●	Inverter RUNNING. Requested direction and actual direction are forward.																																							
●	○	Inverter RUNNING. Requested direction and actual direction are reverse.																																							
○	◐	Inverter RUNNING. Requested direction is forward but actual direction is reverse.																																							
◐	○	Inverter RUNNING. Requested direction is reverse but actual direction is forward.																																							

7 Keypad Menu

7.1 The Menu System

The menu system is divided into a 'tree' structure with up to 6 menu levels. Menu Level 1 is the top level and is accessed by pressing the M key from the start-up display.

The Keypad has selectable "viewing levels" which can restrict the view of the menu system.

Below is a simple description of the menus at Menu Level 1, with the default view level of Technician:

- **OPERATOR**: a customised view of selected parameters contained in the SETUP menu. You can create a working list of parameters for operating your drive. By default, the operator menu contains only parameters **0462 Reference** (setpoint) and **0105 Speed Percent** (feedback), however selection certain application macros will automatically populate the operator menu with relevant additional parameters. Refer to APPENDIX C: Application Macros
- **SETUP**: When in Technician or Engineer view, setup contains all the parameters necessary for the drive to turn the motor. In Operator view, the menu contains only parameter **0002 View Level**.
- **DIAGNOSTICS**: a view of important diagnostic parameters contained in the SETUP menu.
- **ENGINEER**: Only visible when **0002 View Level** is set to Engineer, this menu provides full access to all parameters

7.2 Navigating the Menu

On power-up, the Keypad defaults into the Operator menu, timing out from the start-up screen. You can skip the timeout by pressing the M key immediately after power-up which will take you directly to the Operator menu.

The menu system is a map which is navigated using four keys. Keys E and M navigate through the menu levels. The UP and DOWN keys scroll through the menu and parameter lists.

Because the Menu and Parameter lists are looped, the UP key can quickly move you to the last Menu or Parameter in the loop.

Refer to "The Menu Map" to see how the full menu is mapped in the default Technician view level.

Parameters are presented in alphabetic order.

When in Engineer view (**0002 View Level** = 2) parameters may be accessed directly by navigating to ENG on the AC15 keypad and entering the required parameter, followed by the M key.

7.3 Changing the View Level

The default view level is Technician. To change the view level to Operator or Engineer, use the AC15 keypad or optional 6901 MMI to navigate to the Setup Menu, followed by the Configure Menu, and scroll down to parameter **0002 GKP View Level**. Press M to allow modification. A setting of 0 sets the Operator view level, 1 sets the Technician View Level and 2 sets the Engineer view level. Press E to exit.

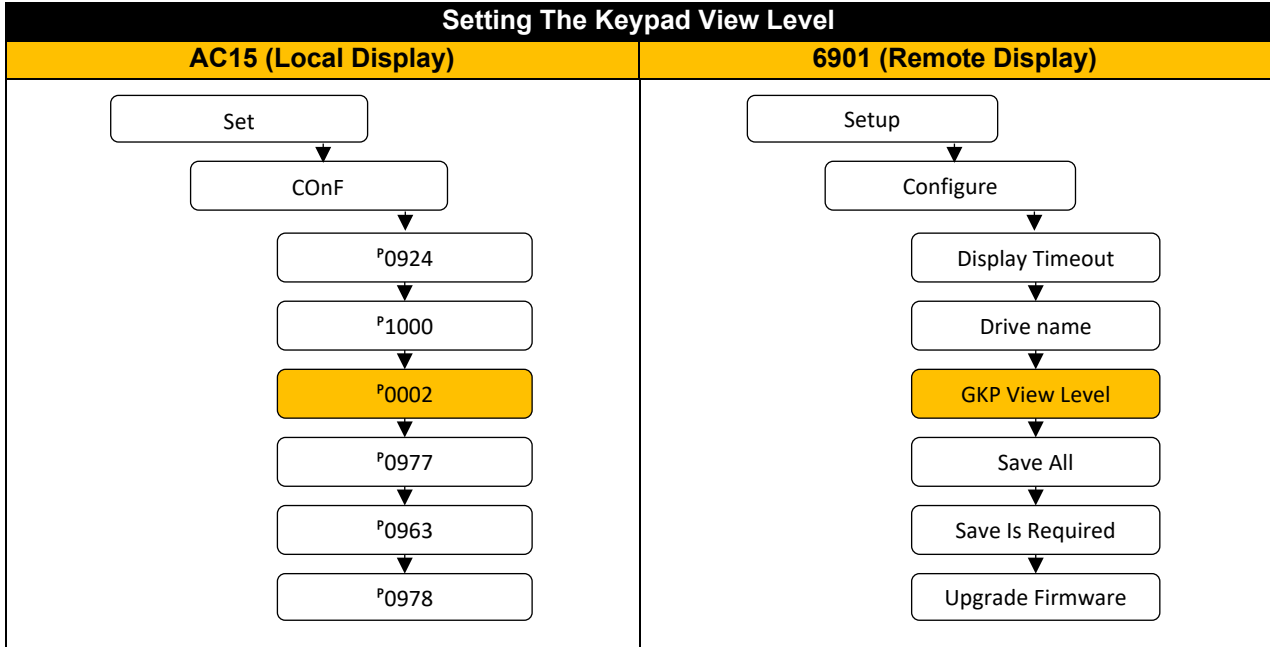

7.4 Saving Parameter Changes

The factory setting for parameter **0928 Enable Auto Save** is 1 (true). With this setting, every parameter change that is made is saved immediately to memory. When commissioning it is sometimes desirable to switch this feature off, such that changes may be 'undone'. Note that if **0928 Enable Auto Save** is set to 0 (false) parameter **0963 Save Is Required** will automatically change to a 1 (true) whenever a parameter has been changed since the last save was performed. This is an indication that the current settings are not saved to memory and a manual save should be performed before powering down.

Parameter **0928 Enable Auto Save** is an Engineering menu level parameter. Therefore, to change from automatic saving to manual, it is first necessary to change the keypad view level to 2 (Engineer) as detailed in the previous section. Then use the AC15 keypad or optional 6901 MMI to navigate to the Setup Menu, followed by the Configure Menu, and scroll down to parameter **0928 Enable Autosave**. Press M to allow modification. A setting of 0 (false) sets the Manual Save, 1 (true) sets Automatic Save. Press E to exit.

Note that it is necessary to perform a parameter save following the change of **0928 Enable Auto Save** to 0 (false) otherwise at the next power cycle the setting will revert to 1 (true).

To perform a manual parameter save, navigate to parameter **0977 Save All** and press M, followed by the UP arrow to toggle the setting to 1 (true). Pressing the E key with parameter **0977 Save All** set to 1 (true) will save all drive parameters, and the keypad will display either AL19 (AC15) or Parameters Saved (6901) when complete.

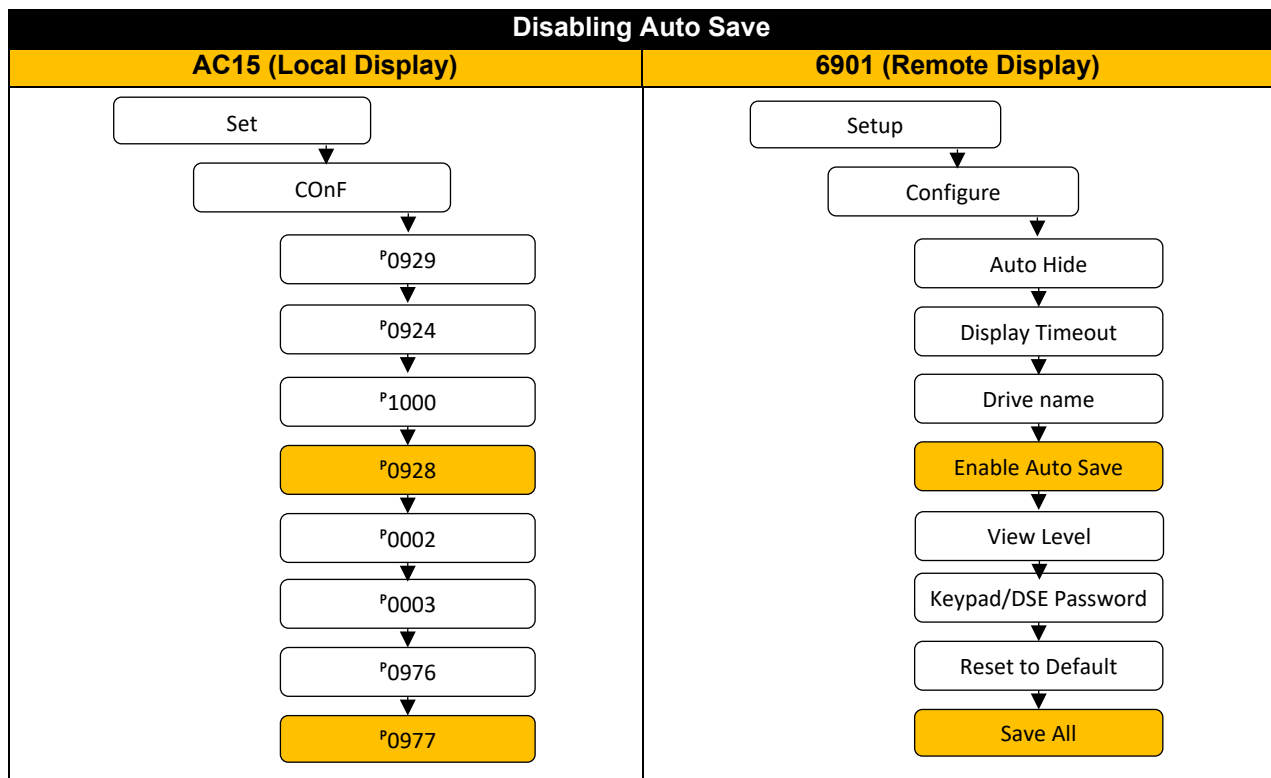

7.5 Resetting to Factory Defaults

It may sometimes be necessary to perform a complete factory reset of the AC15 inverter. Care must be taken to ensure that either a full backup of settings has been made either to a Clone file on a SD card or to a DSE Lite configuration, as resetting will erase all parameters.

If parameter **0928 Enable Autosave** is set true (default) then performing a reset cannot be undone, since the drive will automatically save any parameter that is changed, including when parameters are reset to default. Setting parameter **0928 Enable Autosave** to 0 (false) and saving that setting BEFORE performing a reset will allow the full reset to be undone by cycling power, since the reset will not be automatically saved.

Parameter **0976 Reset to Default** is an Engineering menu level parameter. Therefore, to change from automatic saving to manual, it is first necessary to change the keypad view level to 2 (Engineer) as detailed in the previous section. Then use the AC15 keypad or optional 6901 MMI to navigate to the Setup Menu, followed by the Configure Menu, and scroll down to parameter **0976 Reset to Default**. Press M to allow modification. Pressing the UP arrow will change the setting to 1(True). Press E to exit and perform the reset. The keypad will display either AL16 (AC15) or Defaults Loaded (6901) when complete.

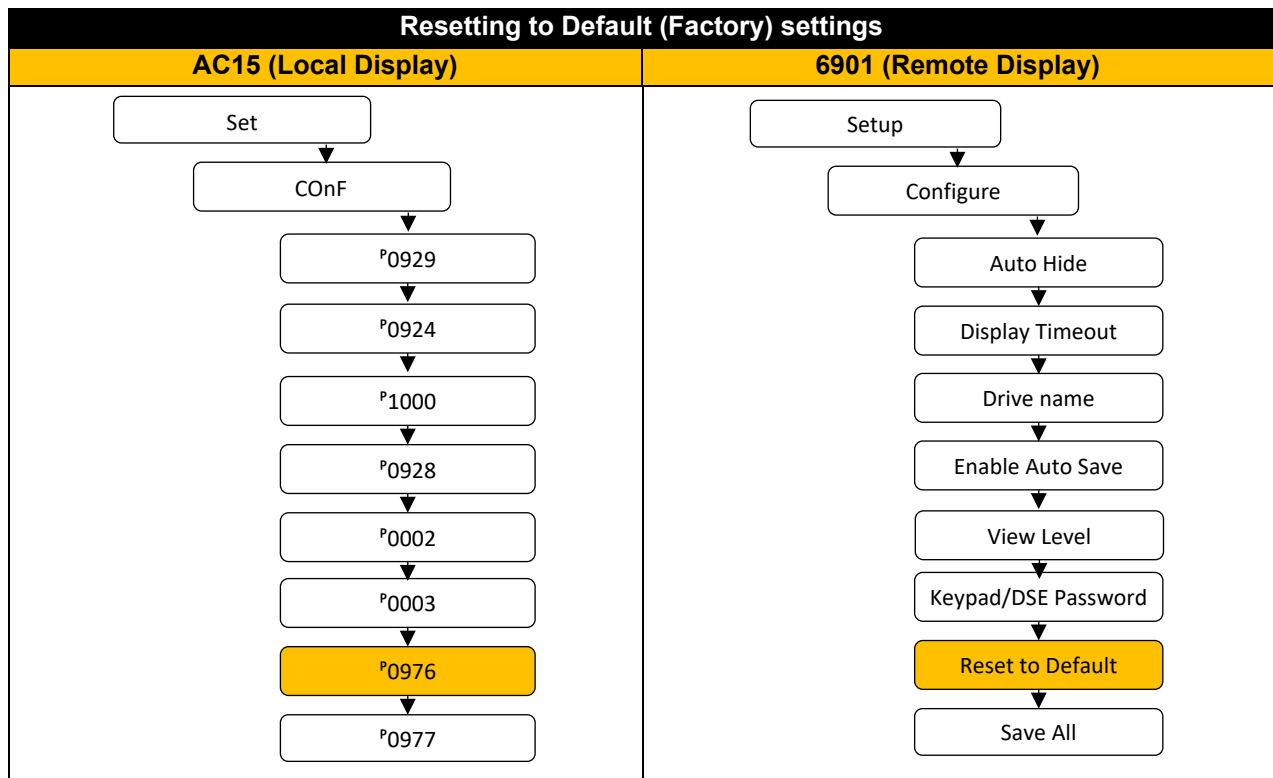

7.6 Updating Firmware

The firmware of the AC15 may be updated either through DSE Lite, or by using an SD card loaded with the required firmware file. Updating via DSE Lite is detailed in section 9.2 “Connecting to DSE Lite”.

To update using an SD card it is first necessary to load the required firmware file on to a microSD card formatted with the FAT32 file structure. The firmware file must be saved into the root of the SD card with the name “firmware.ac1” for frame 1, and “firmware.ac2” for frames 2-5.

Use the AC15 keypad or optional 6901 MMI to navigate to the Setup Menu, followed by the Configure Menu, and scroll down to parameter **0978 Upgrade Firmware**. Press M to allow modification. Pressing the UP arrow will change the setting to 1 (True). Press E to exit and perform the upgrade. The keypad will display the “boot” while updating and the current (new) version of firmware when complete.

7.7 AC15 Menu Structure

The menu structure listed assumes the default view level of 'Technician' is active. Setting the view level to 'Operator' will hide all setup parameter menus. Setting the view level to Engineer adds extra menus only when a 6901 keypad is connected. If no 6901 is fitted, in Engineer view parameters may be accessed directly by navigating to ENG on the AC15 keypad and entering the required parameter number.

On the left side of the table the AC15 display/parameter number is listed. On the right side the 6901 display/DSE Lite parameter name is listed.

Certain parameters only become visible when other parameters are set. For example, parameters related to a PMAC motor will appear only when parameter **0030 Motor Type** is set to PMAC. Those parameters that are not always visible are highlighted in the map with differing colours.

Top Level Menu

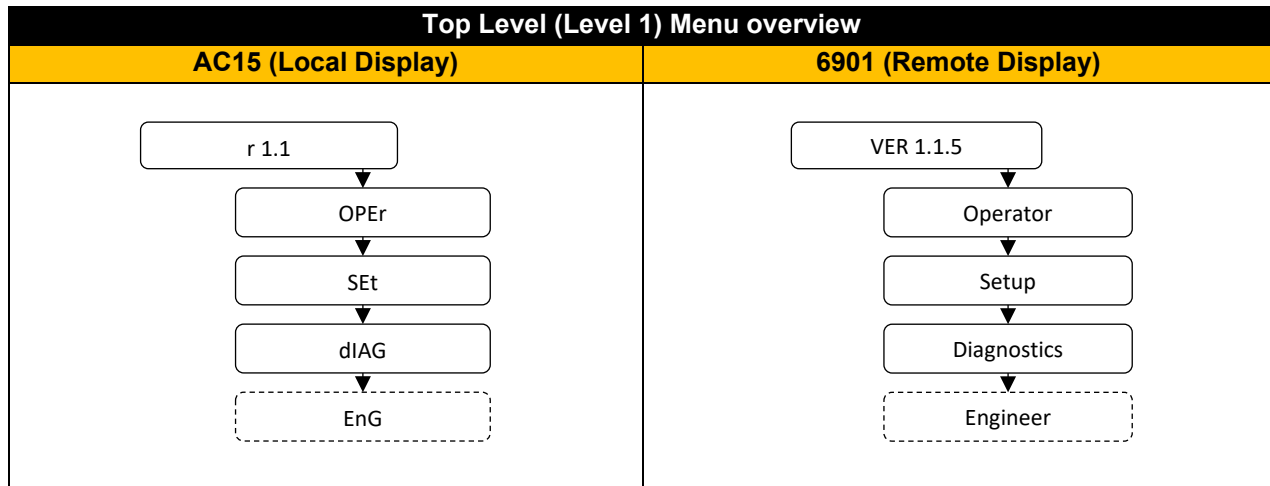

Operator Level Menu

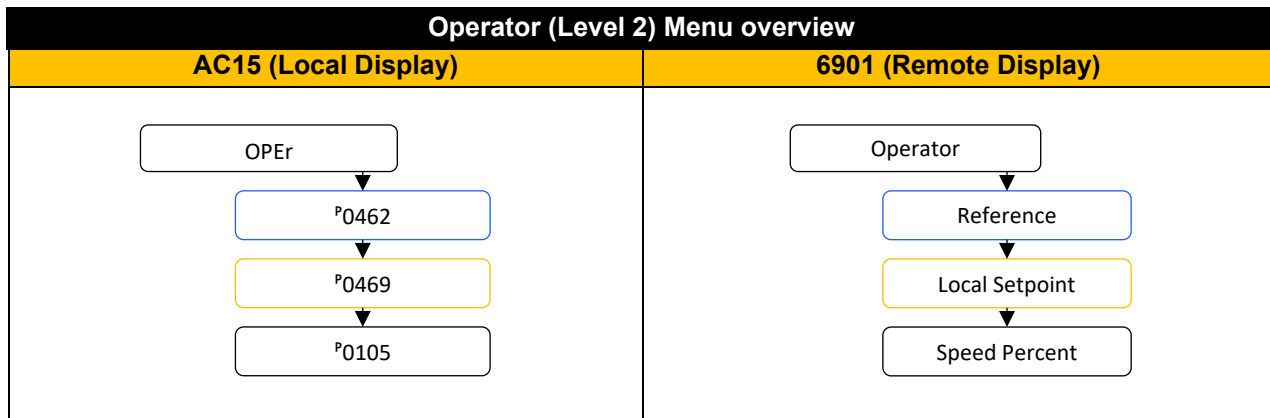

Note : Parameter P0462 will be displayed if the drive is in 'Remote' mode.

Parameter P0469 will displayed if the drive is in 'Local' mode.

Setup Level Menu

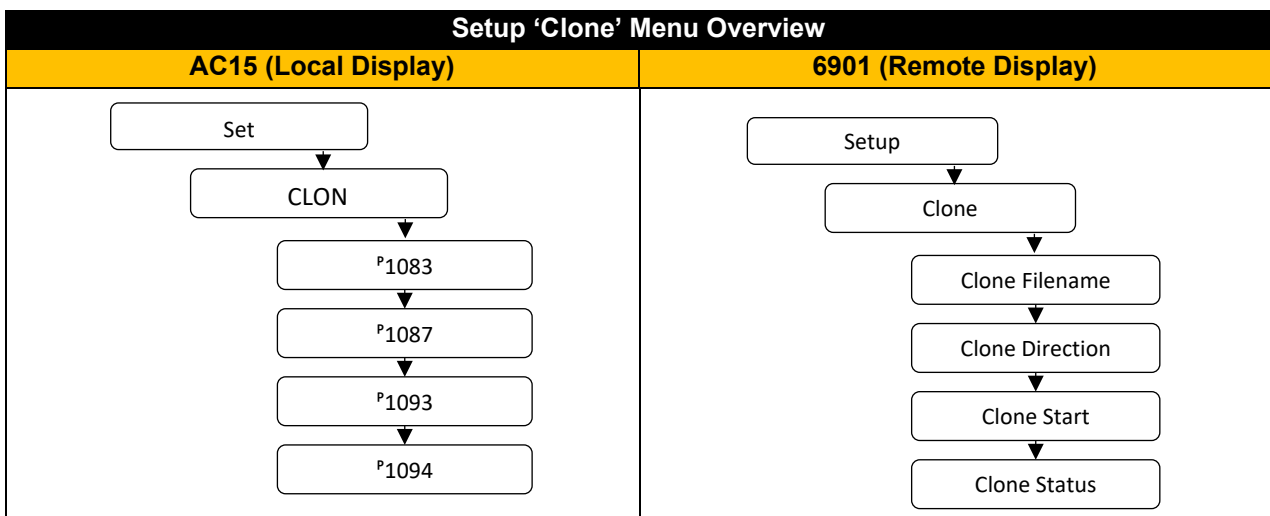
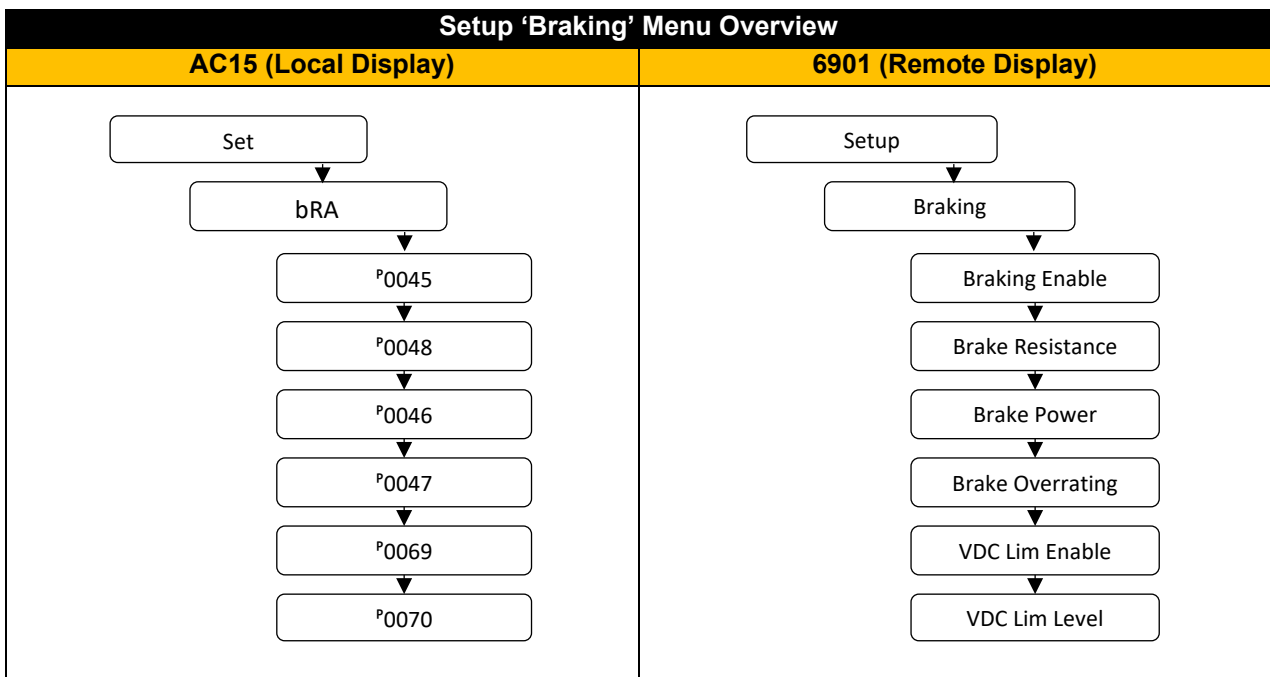
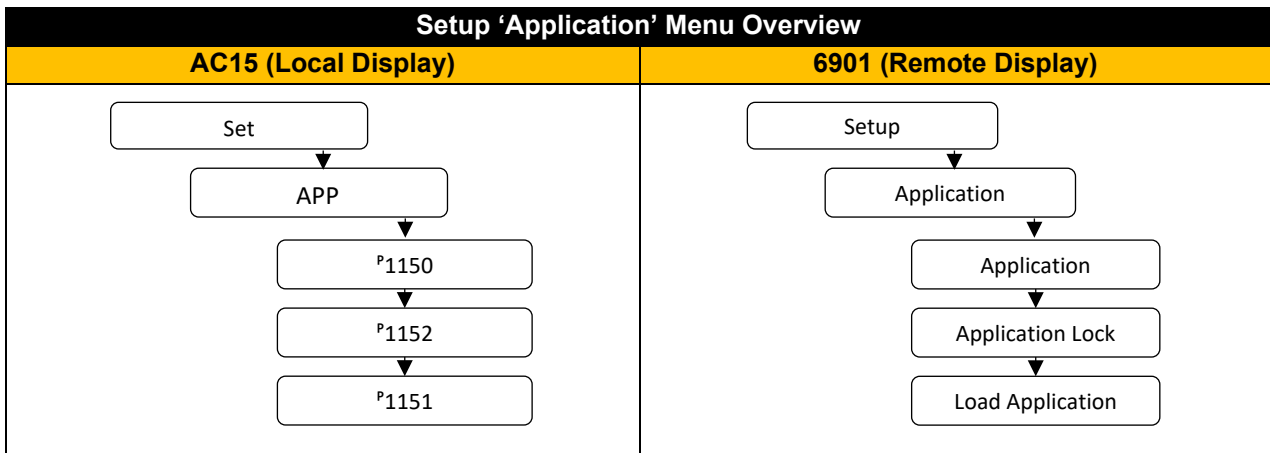

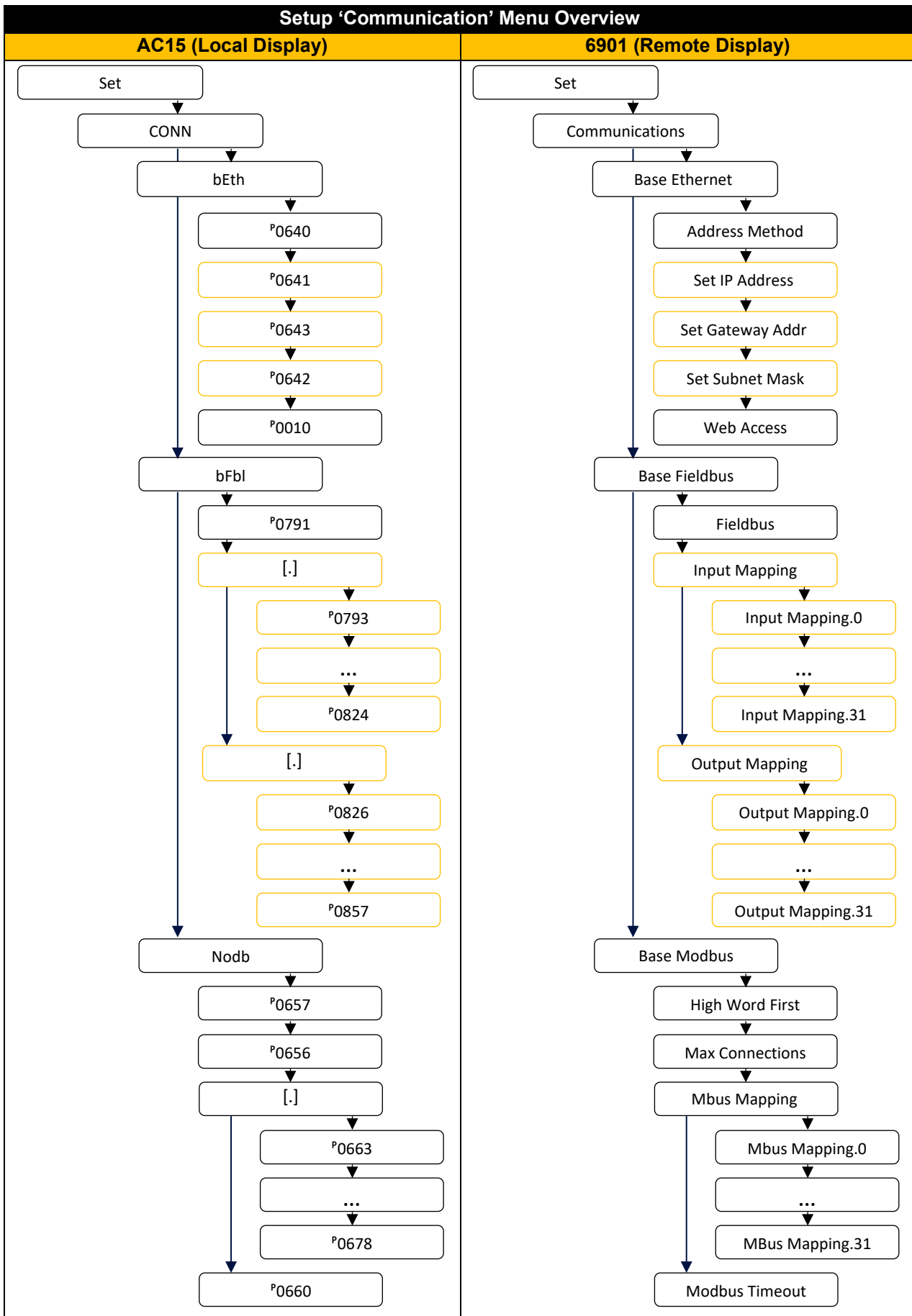

Note : Parameters **P0641 Set IP Address**, **P0643 Set Gateway Addr** and **P0642 Set Subnet Mask** will be displayed only if **P0640 Address Method** is set to **0** (Fixed).
 Parameters **P0793 Input mapping.01** through **P0857 Output Mapping.31** will be displayed only if **P0791 Fieldbus** is set to 1 (Ethernet IP).

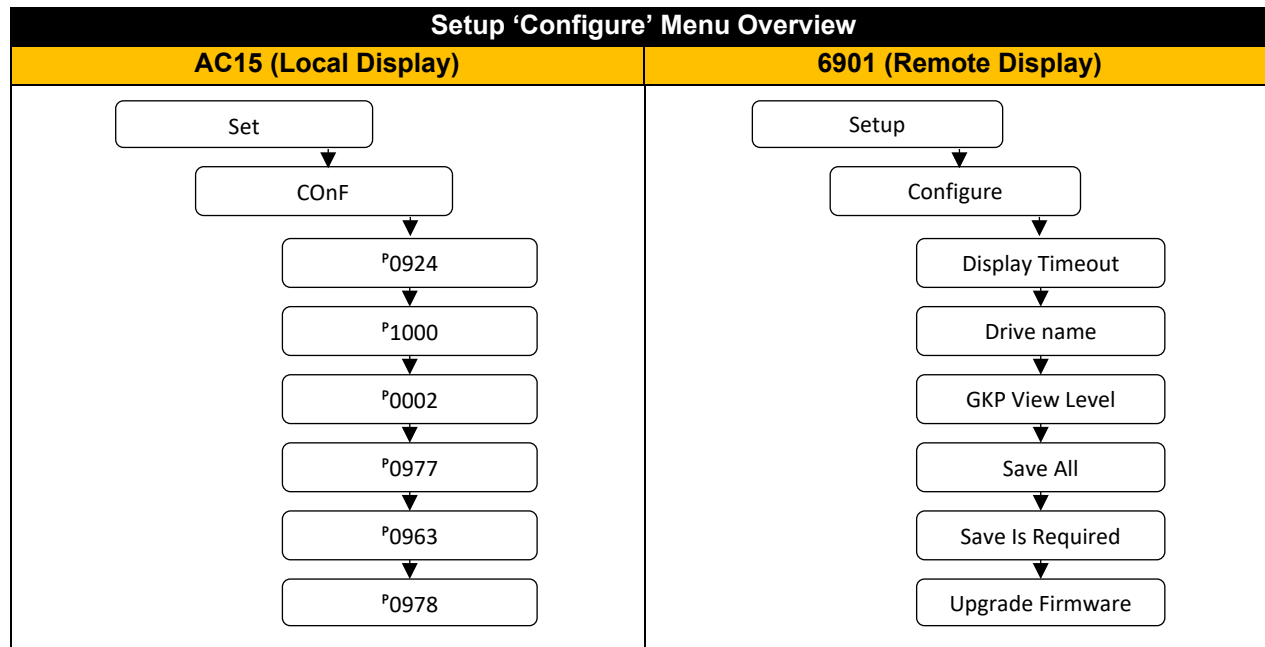

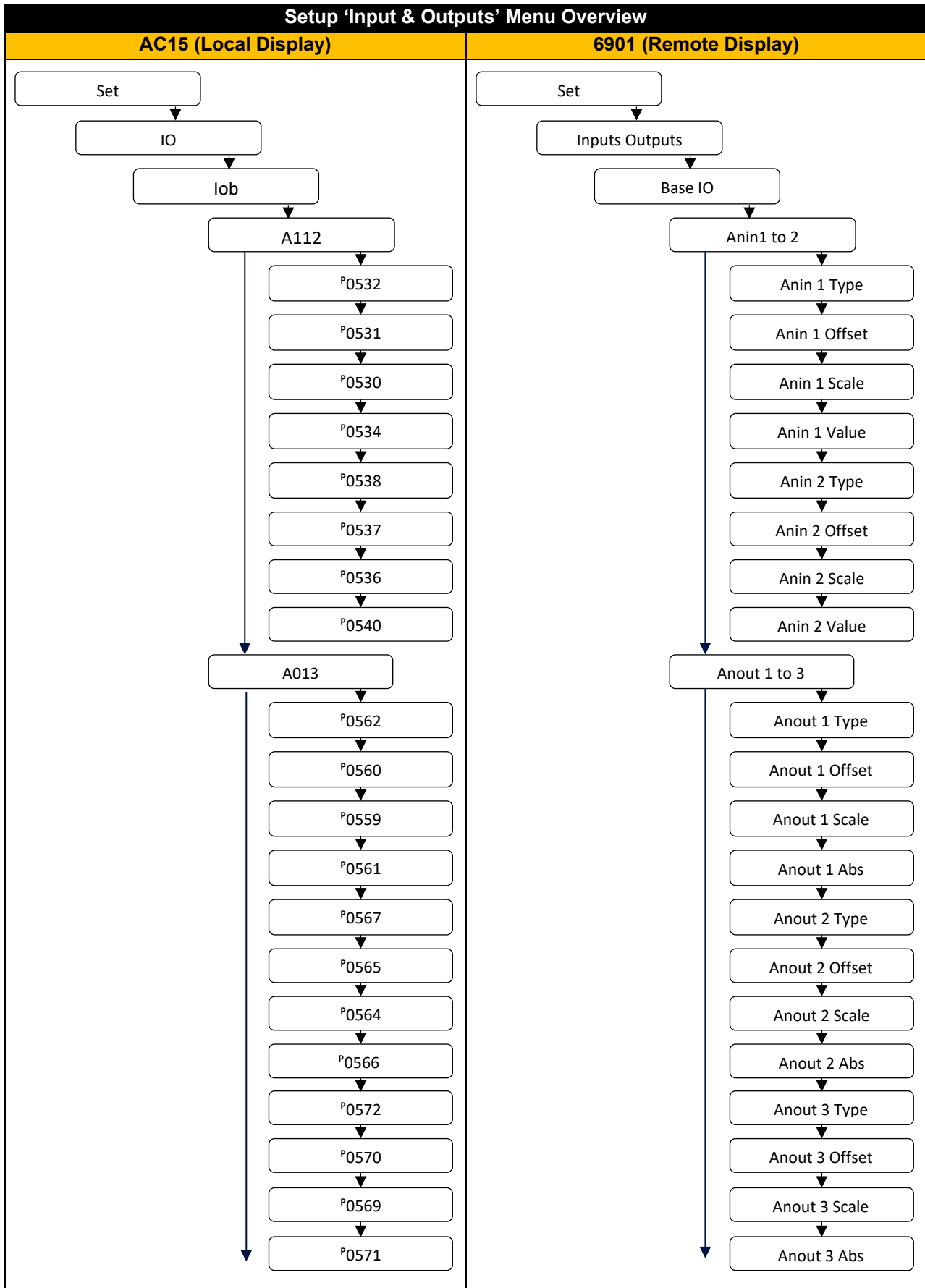

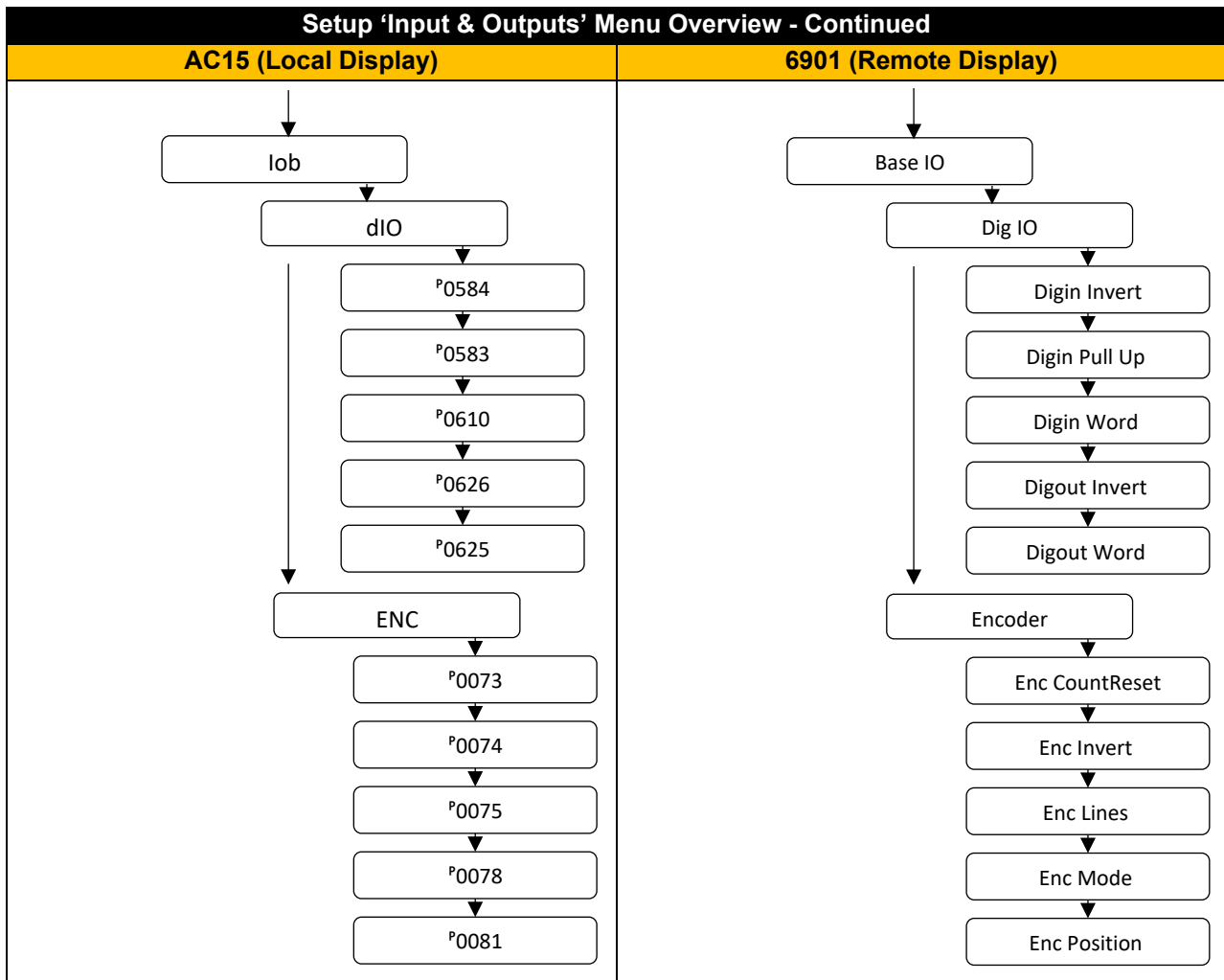

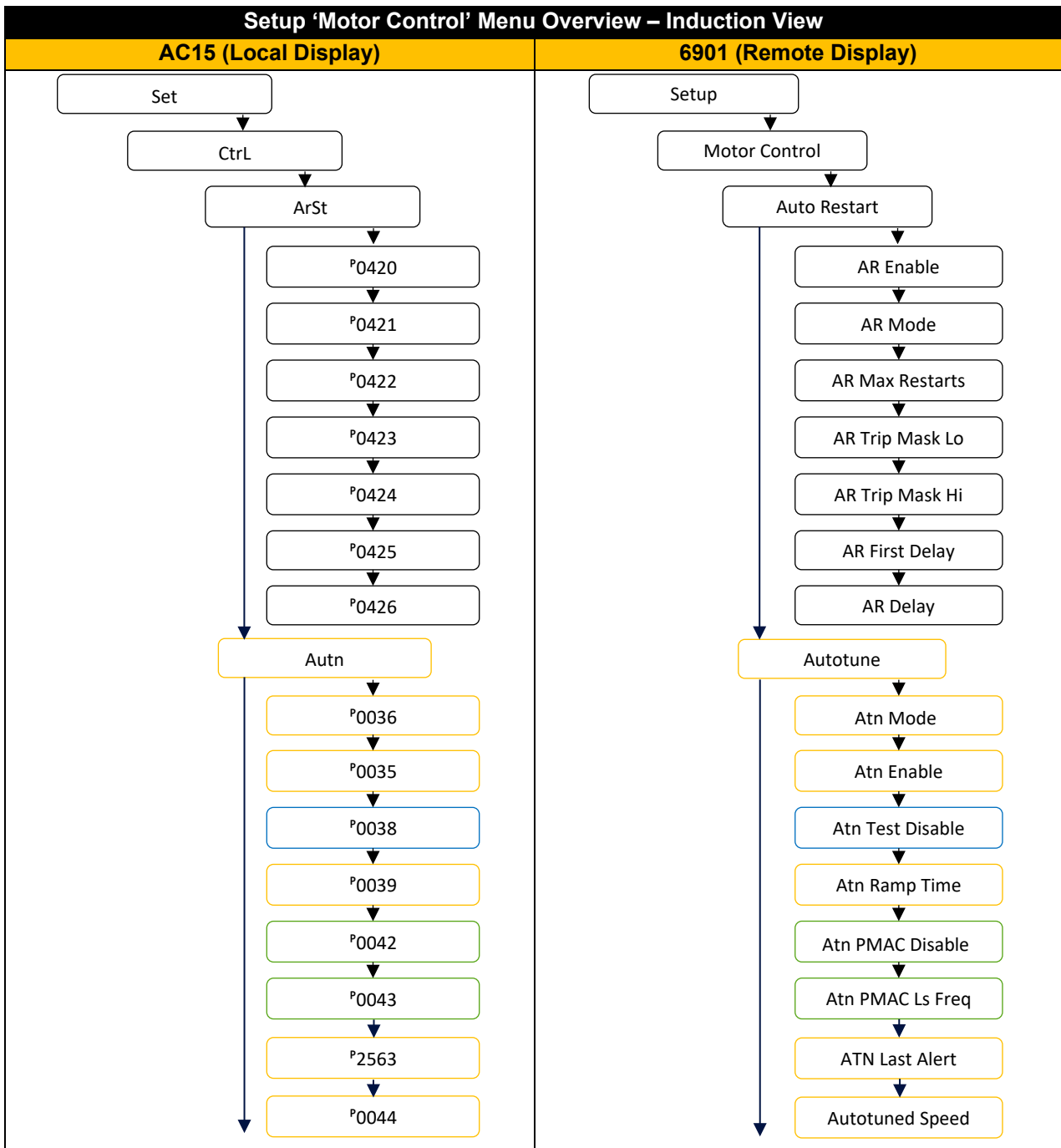

Note : The above map is valid only when **P0030 Motor Type** is set to 0 (Induction Motor).

The **Autotune** menu will be displayed only if parameter **P0030 Motor Type** is set to 1 (PMAC Motor) or parameter **P0031 Control Strategy** is set to 1 (Vector Control).

Parameter **P0038 Atn Test Disable** will be displayed only if **P0031 Control Strategy** is set to 1 (Vector Control).

Parameters **P0042 Atn PMAC Disable** and **P0043 Atn PMAC Ls Freq** will be displayed only if parameter **P0030 Motor Type** is set to 1 (PMAC Motor).

Setup 'Motor Control' Menu Overview – Induction View

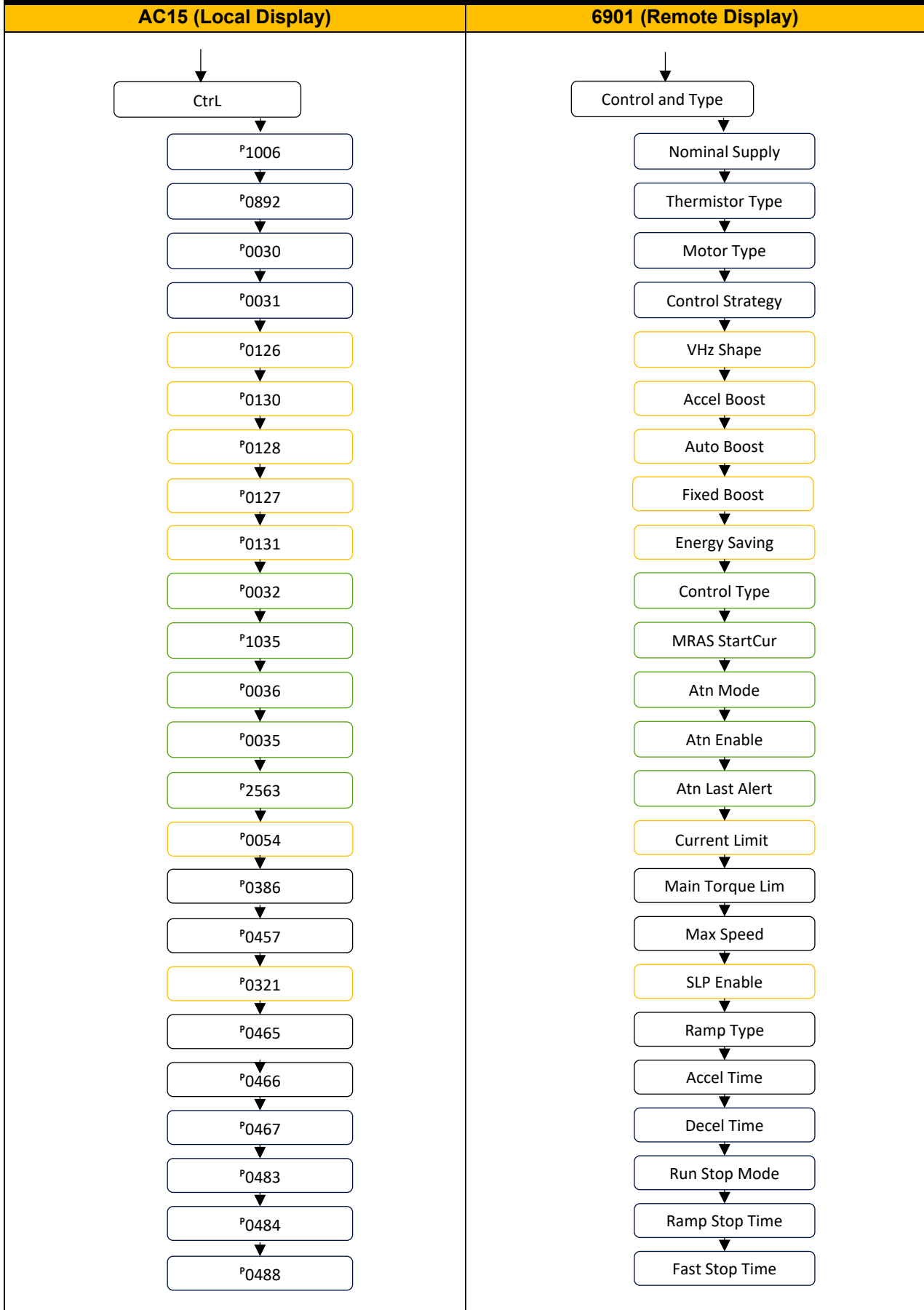

Note : The above map is valid only when **P0030 Motor Type** is set to 0 (Induction Motor).

Parameters **P0126 Vhz Shape**, **P0130 Accel Boost**, **P0128 Auto Boost**, **P0127 Fixed Boost**, **P0131 Energy saving**, **P0054 Current Limit** and **P0321 SLP Enable** will be displayed only if parameter **P0031 Control Strategy** is set to 0 (Volts-Hertz Control).

Parameters **P0032 Control Type**, **P1035 MRAS StartCur**, **P0036 Atn Mode**, **P0035 Atn Enable** and **P2563 Atn Last Alert** will be displayed only if parameter **P0031 Control Strategy** is set to 1 (Vector Control).

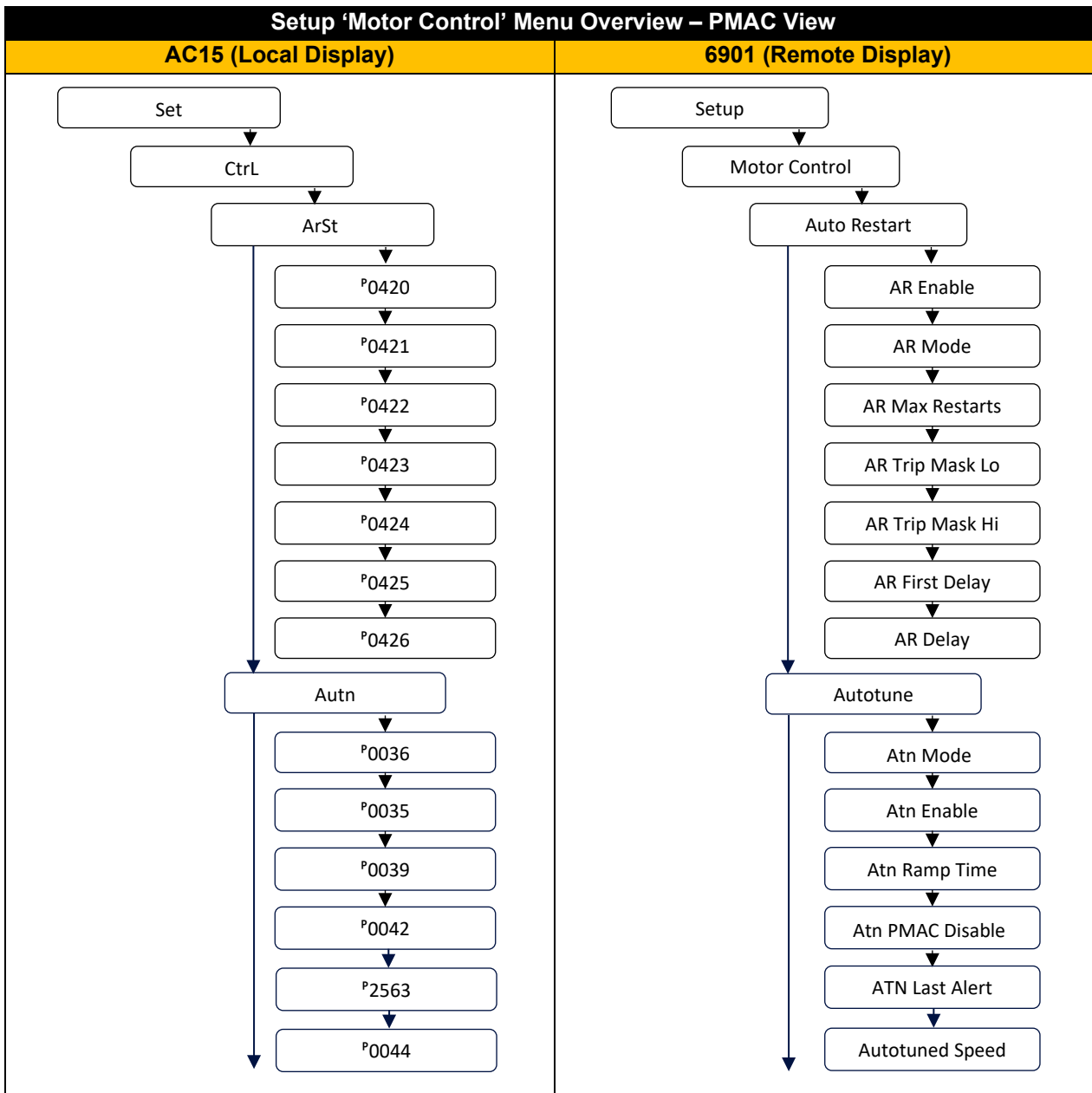

Note : The above map is valid only when **P0030 Motor Type** is set to 1 (PMAC Motor).

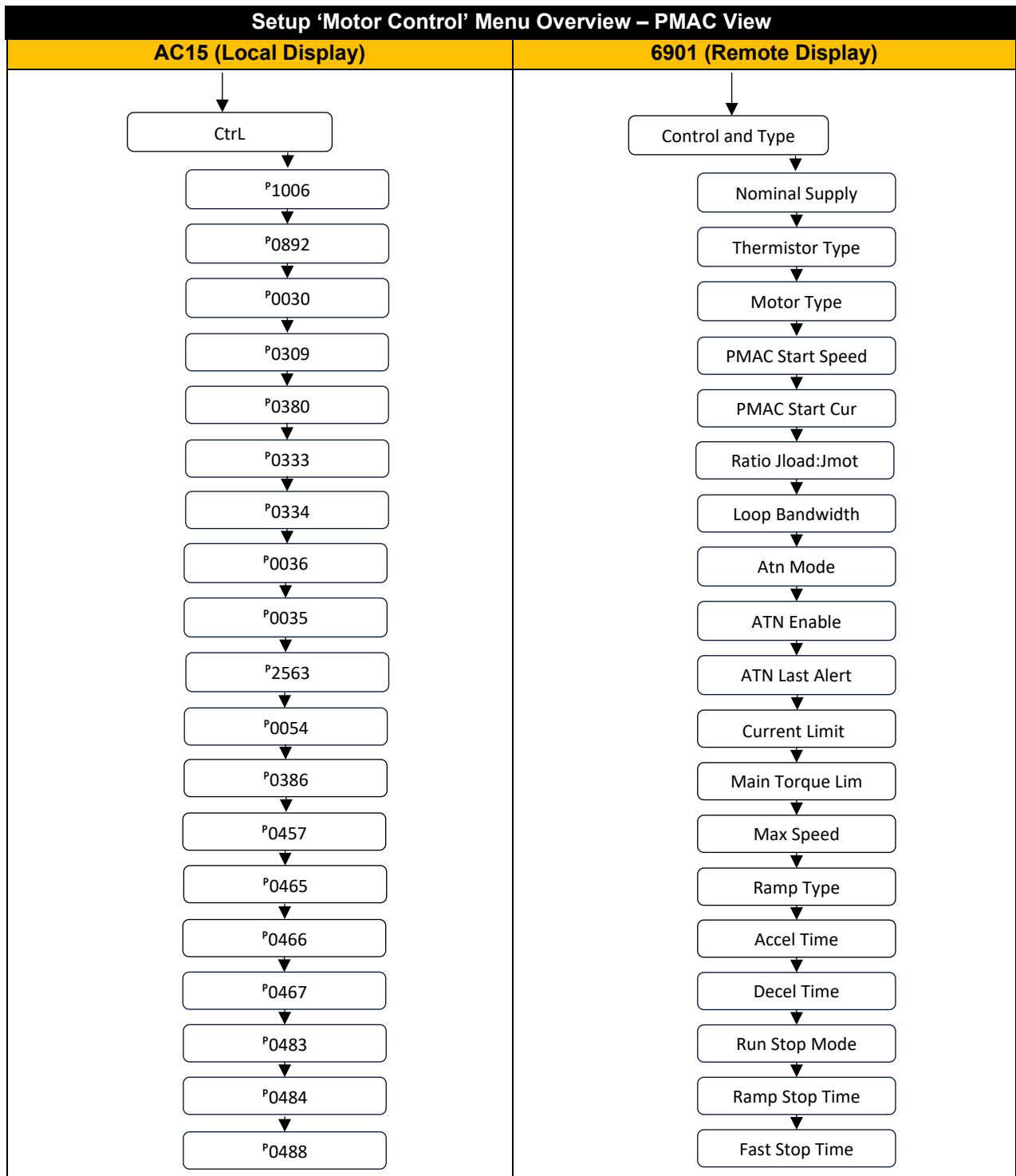

Note : The above map is valid only when **P0030 Motor Type** is set to 1 (PMAC Motor).

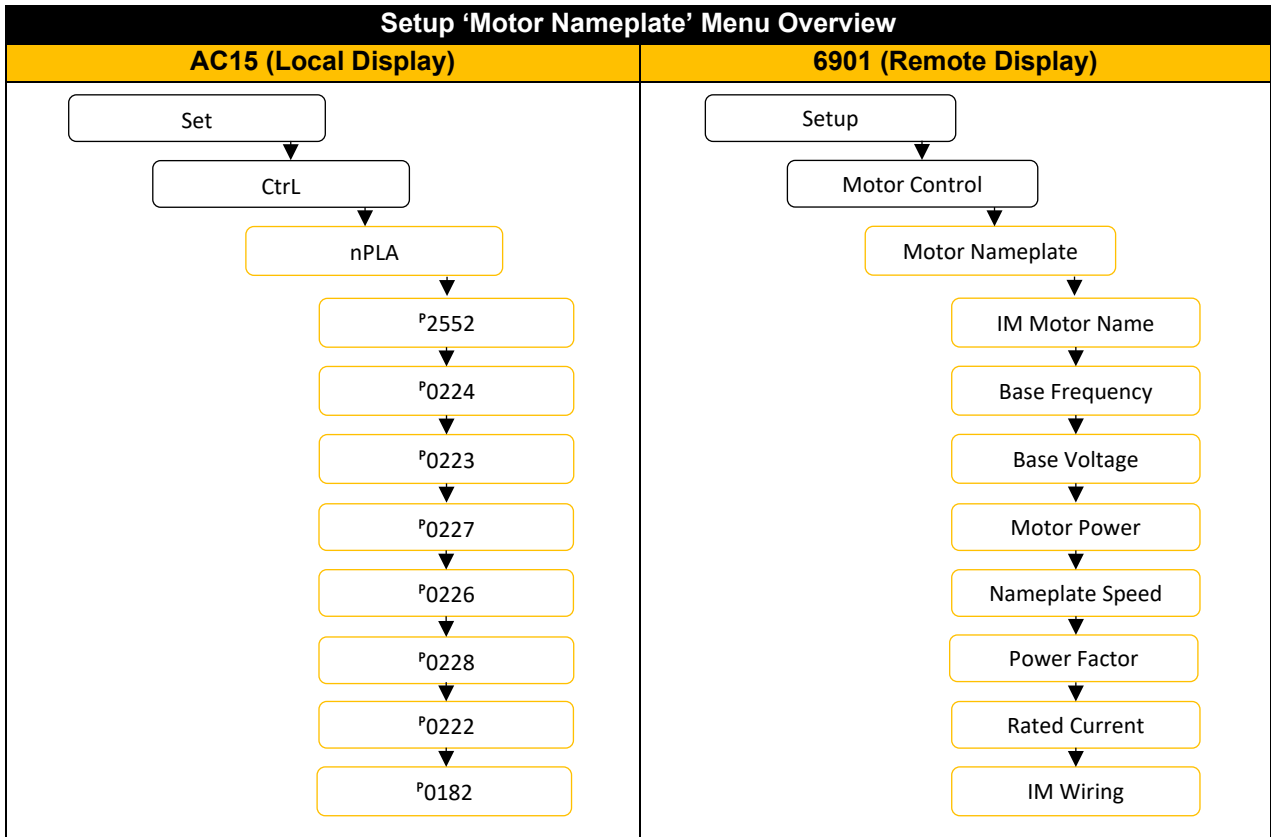

Note : The above map is only displayed when **P0030 Motor Type** is set to 0 (Induction Motor).

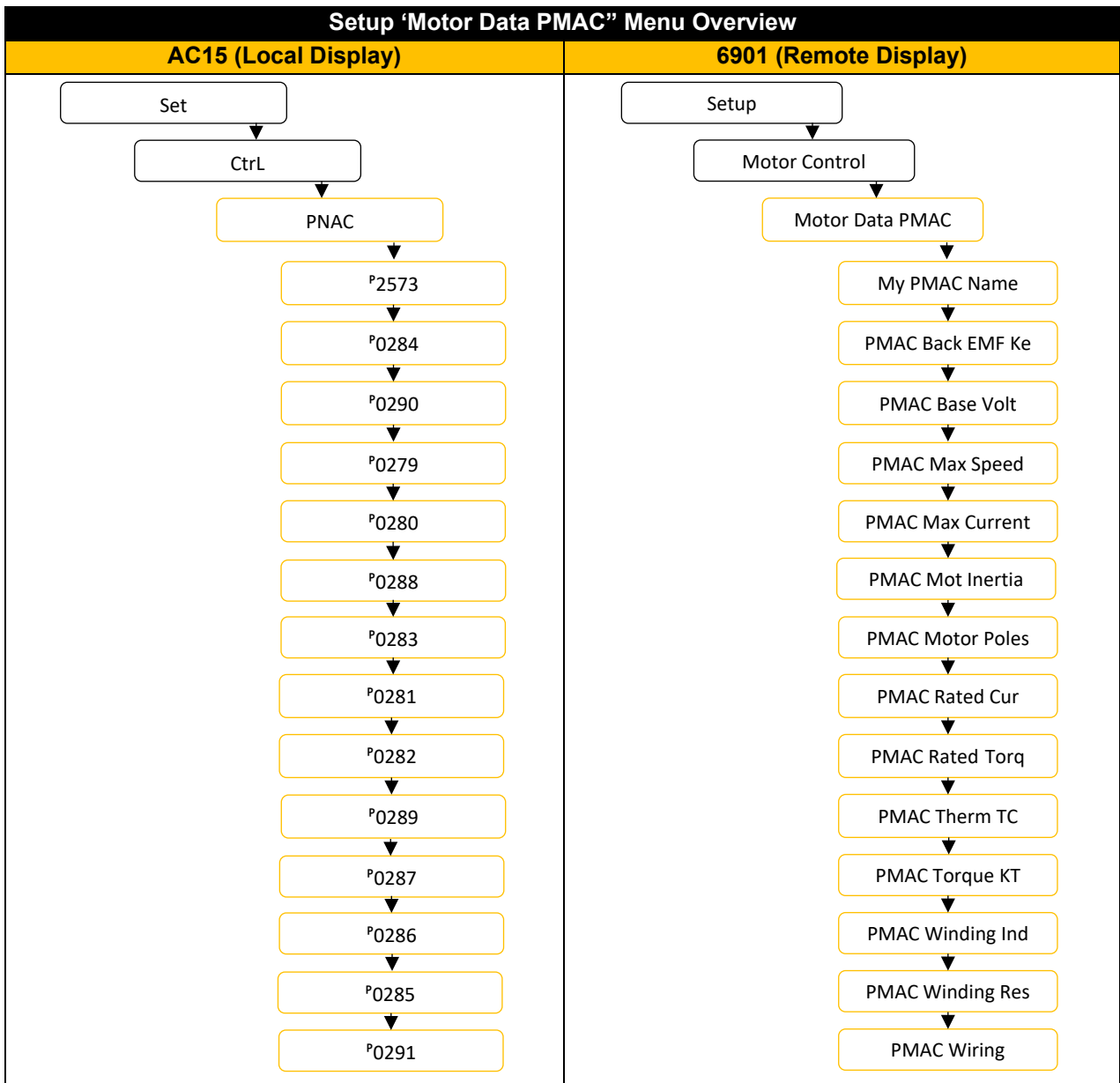

Note : The above map is only displayed when **P0030 Motor Type** is set to 1 (PMAC Motor).

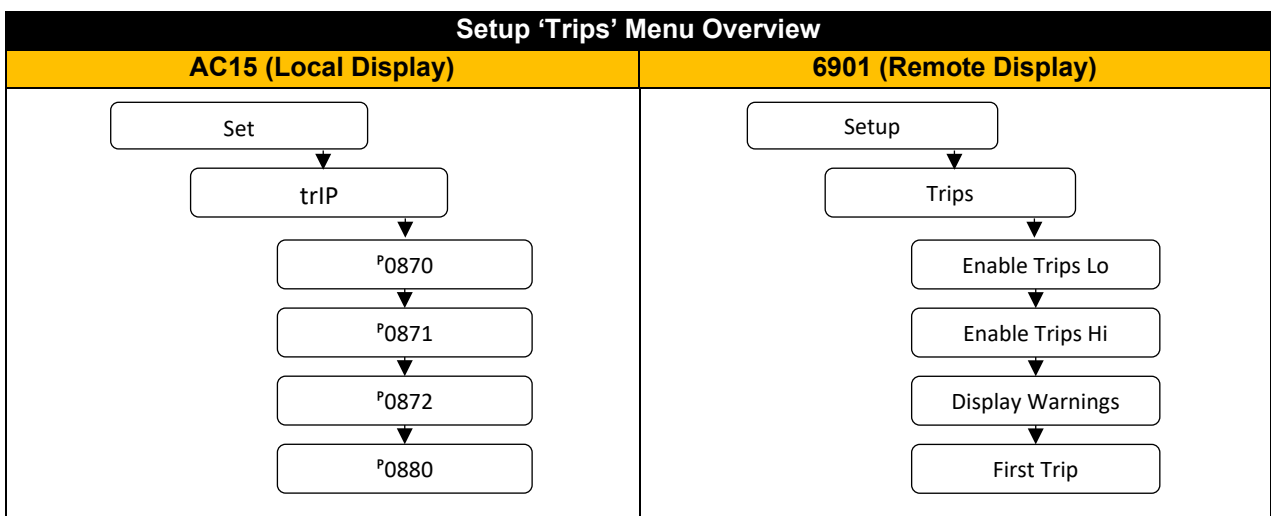

Diagnostics Level Menu

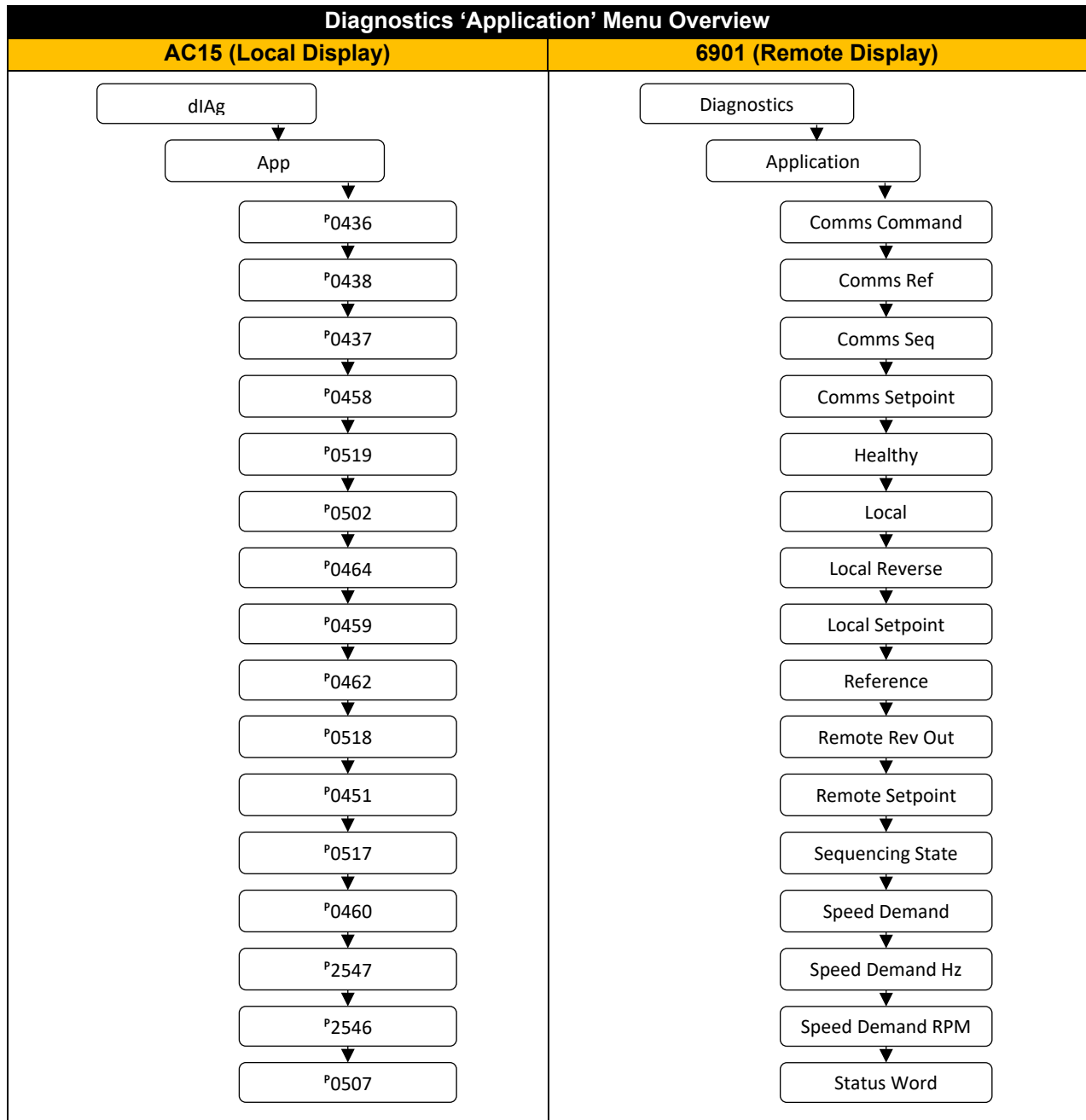

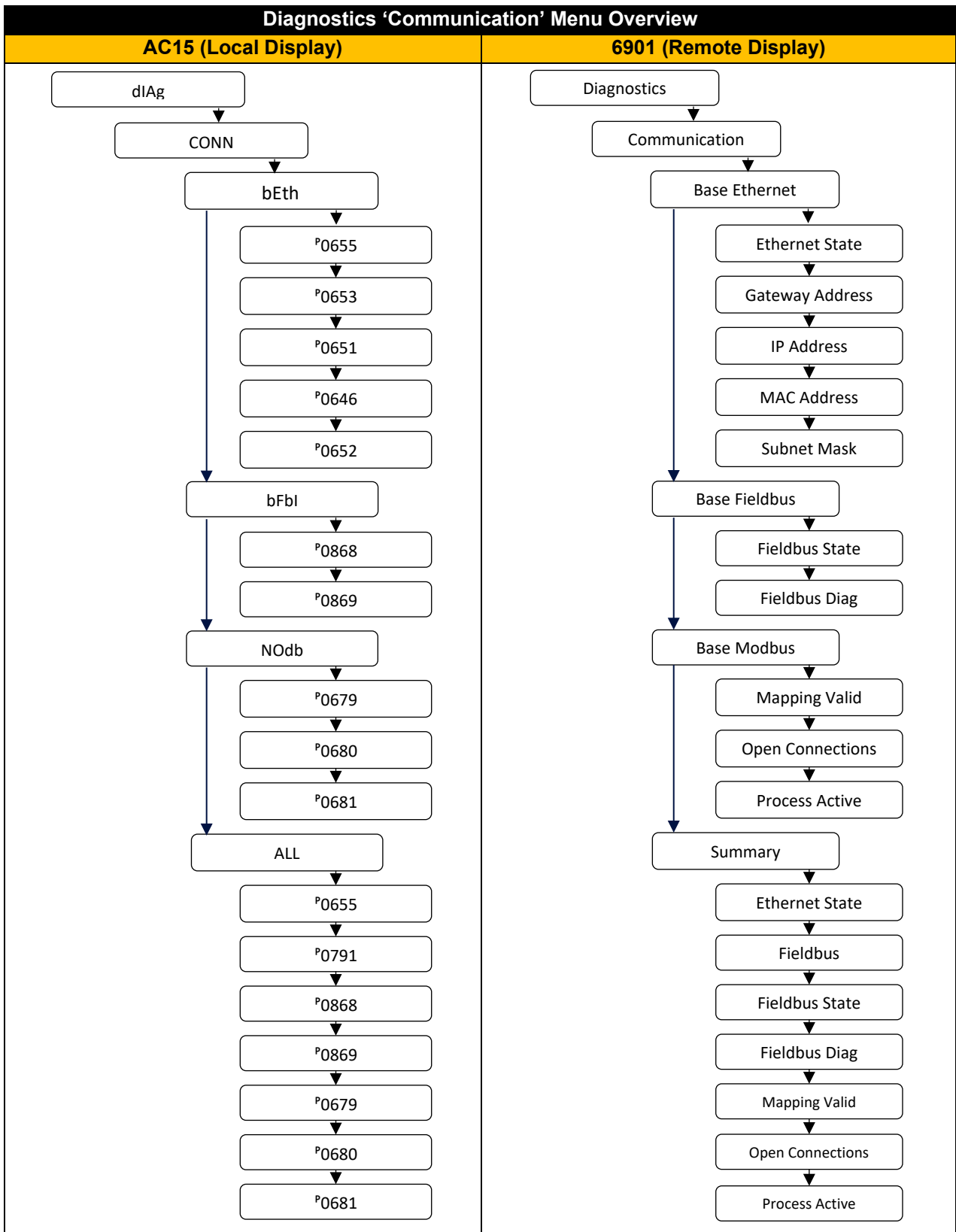

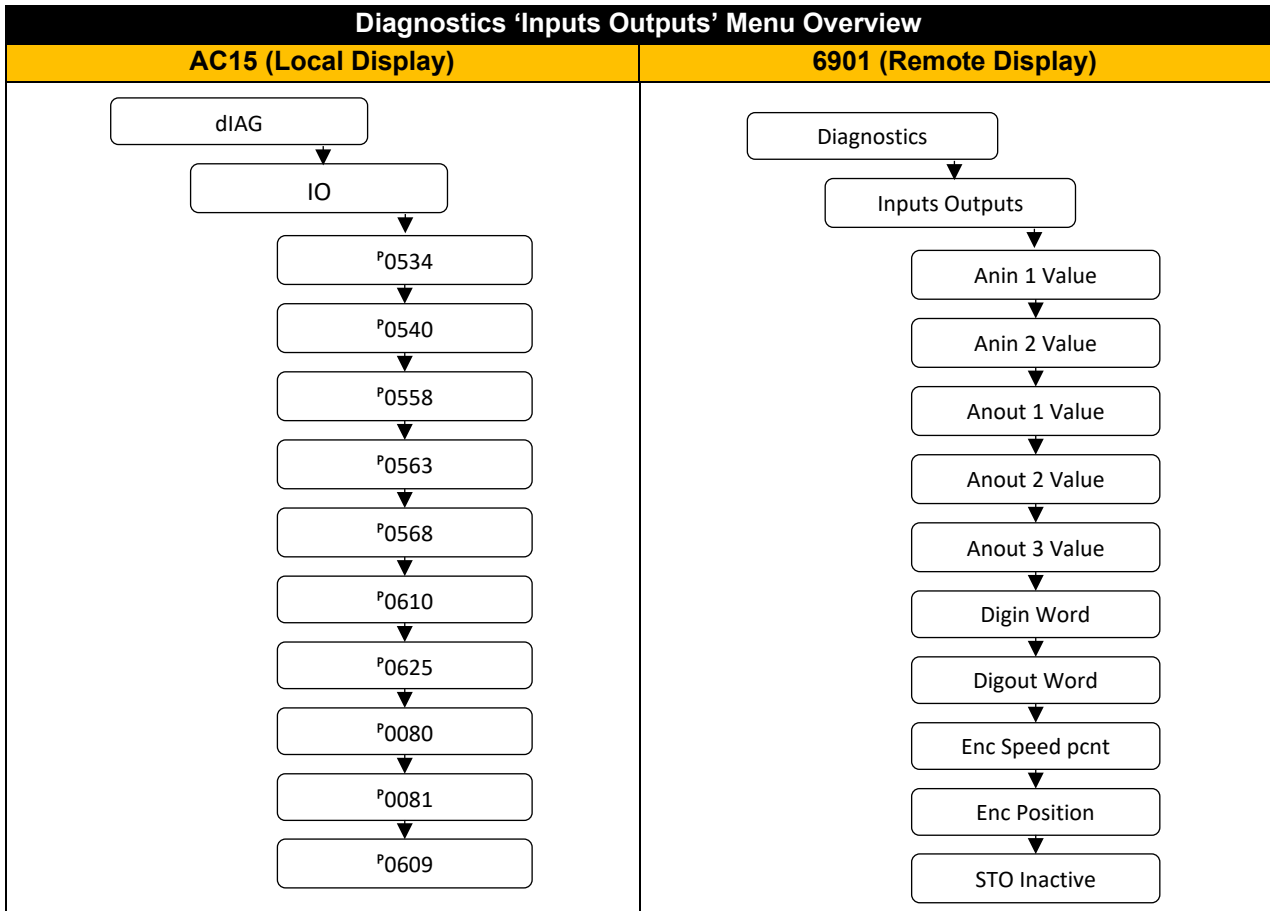
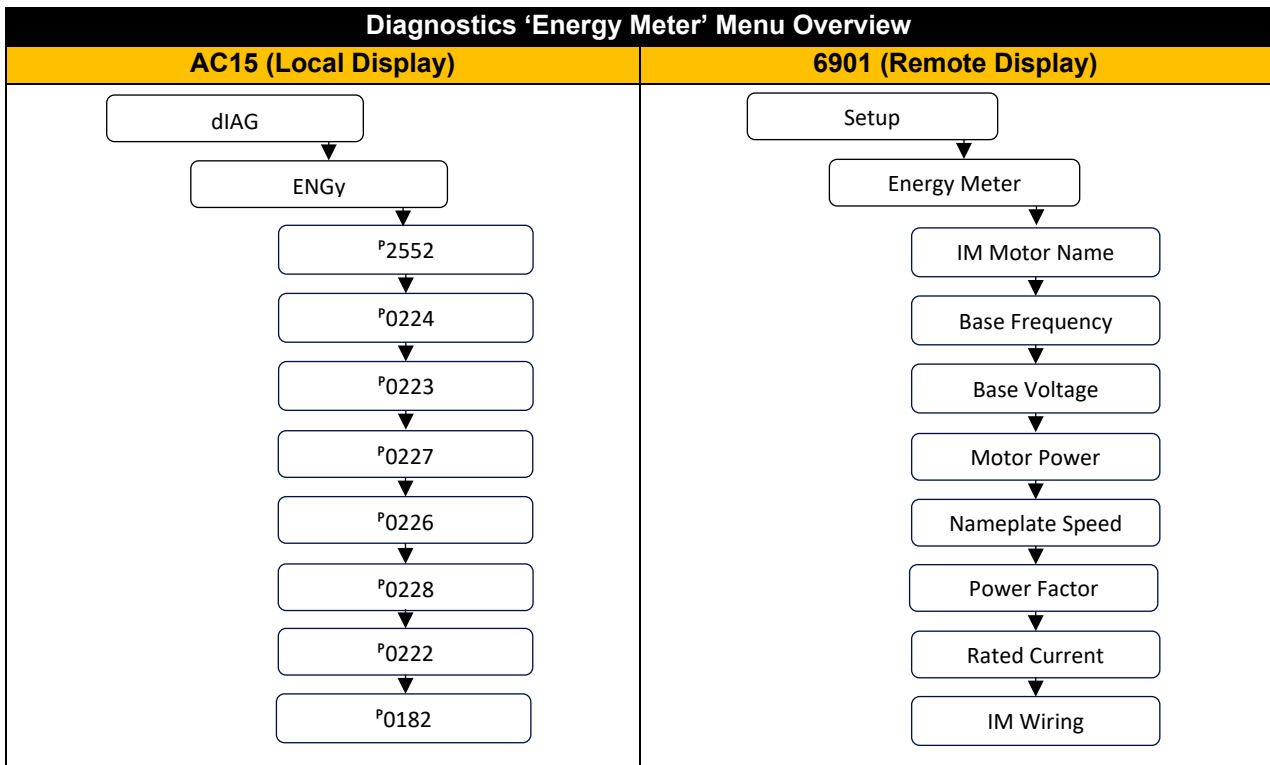

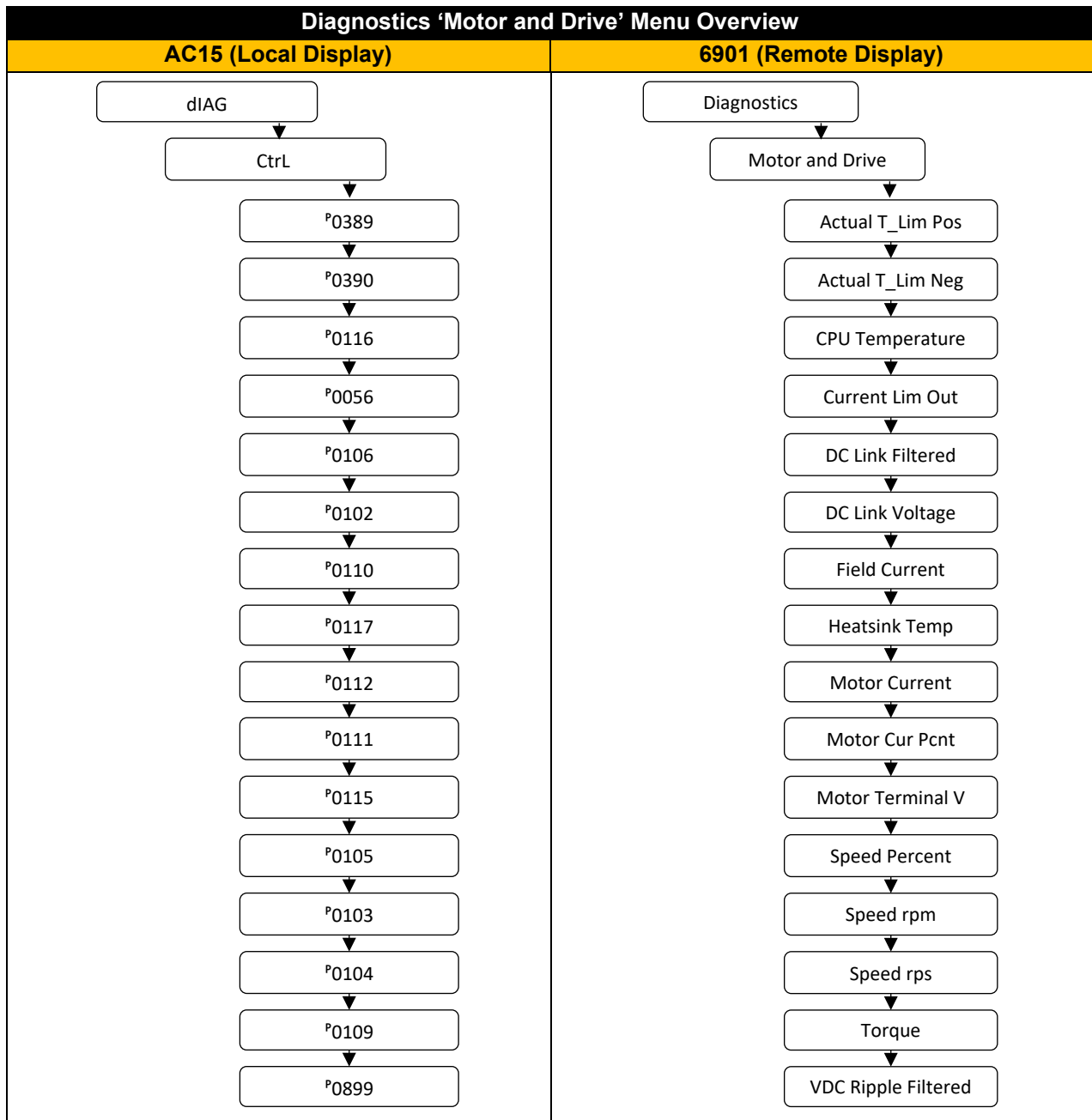

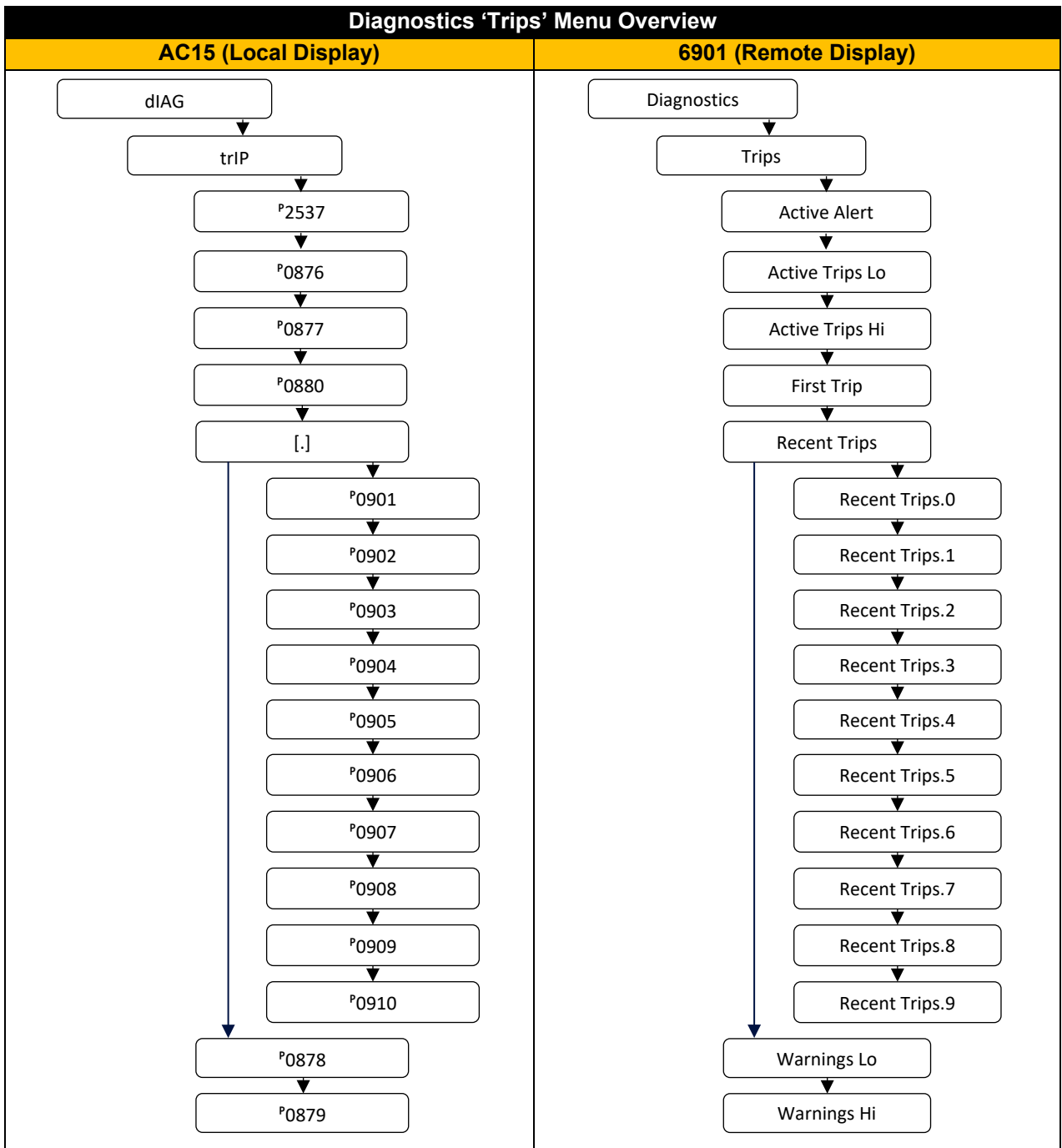

8 Communications

Communication to the inverter is achieved via the Ethernet port on the front of the AC15. This allows a provides connection for:

- DSE Lite programming tool
- The Modbus TCP server
- The HTTP server
- EtherNet/IP adapter (Frames 2-5 only)

The Ethernet operates at 10/100 MHz, half/full duplex. Internet Protocol version 4 (IPv4) is supported. The RS232 (RJ11) port is intended for connection of a 6901 remote keypad and is not suitable for connection to a PC or for serial communications.

8.1 Connecting to the Inverter

Recommended Ethernet Cables

Cat 5e or Cat 6 screened Ethernet cables are recommended for connecting to the control board RJ45 socket. Connection is recommended via an Ethernet switch, however direct connection between PC and inverter is supported, with or without a crossover Ethernet cable.



8.2 Connecting to DSE Lite

The recommended method of programming the AC15 inverter is DSE Lite, version 3.12 or later. The latest version of DSE Lite may be downloaded from Parker.com.

By default, all AC15 ship with an 'Address Method' of 'Automatic'. If connected to a DHCP network the AC15 will obtain an address from the DHCP server. If there is not DHCP server, or a direct connection is made to a PC, an IP address in the range 169.254.xxx.xxx is automatically assigned. It is therefore preferable for the PC running DSE Lite to have an IP address in the same range.

The PC network adapter may be configured to this range as shown below (IPv4 is used for communication).

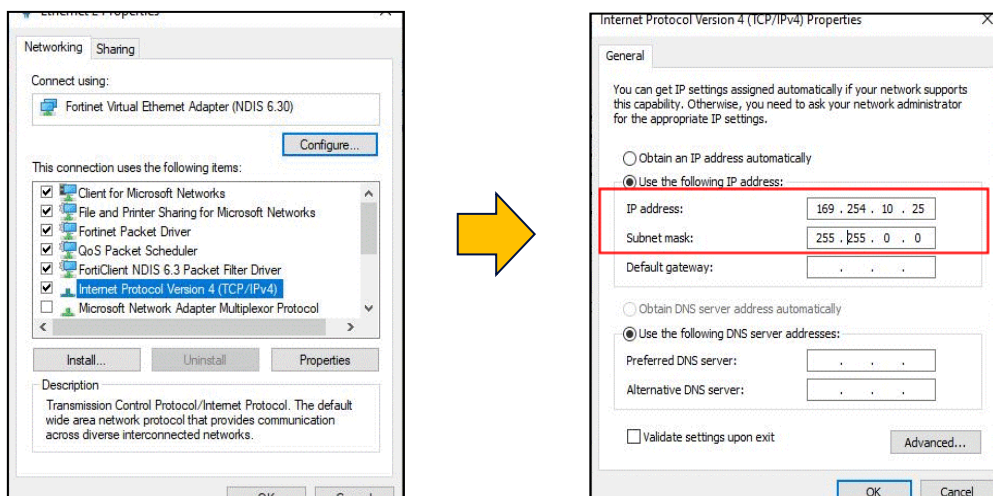

Alternatively, the IP address of the drive may be changed to suit the settings of the PC network adapter. The IP address of the drive can be configured using the DCT function, accessible from within DSE Lite by selecting Command -> Install AC15/AC20 Firmware.



Selecting 'Install AC15/20 Firmware' will open the DCT plugin, as shown below. Clicking on the "Scan" button will start a network search for all connected AC15 products. Once the network scan is completed, any AC15 that have been found will appear, and the Ethernet settings can be edited.

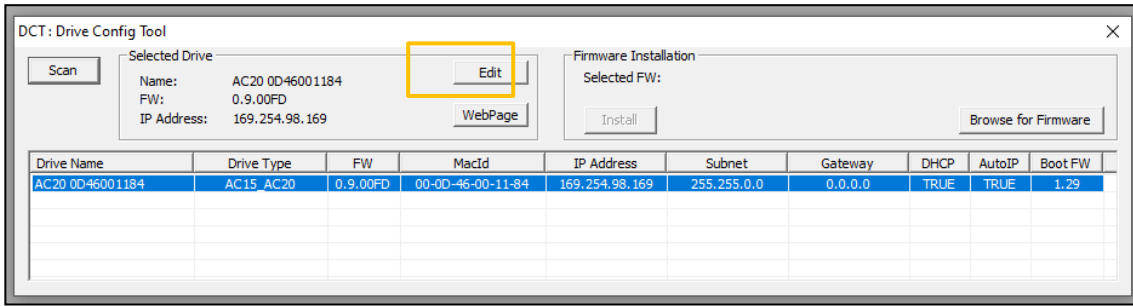

Clicking “Edit” will display the Ethernet configuration dialog box. Auto-IP or DHCP may be selected if required, however the simplest method is to manually assign the connected drive an IP address and a Subnet Mask that matches the host PC.

Note that more than one AC15 may be connected to the network at any time. It is therefore advisable to set a meaningful name at this point, so that the inverter may be easily identified later.

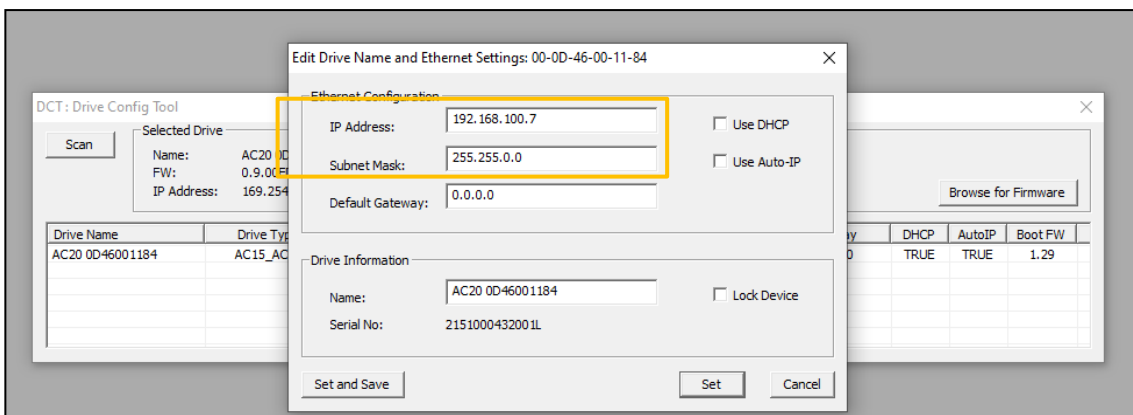

Once changes have been made, click on “Set” or “Set and Save” as appropriate. It is advisable to run a new network scan once the settings have been changed, to ensure the changes were made successfully and that DSE Lite can find the inverter on the network.

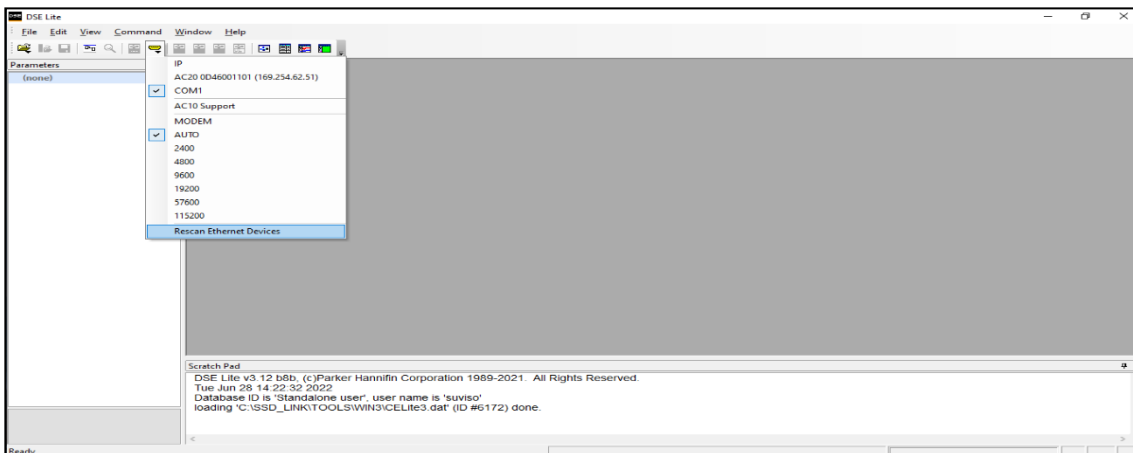

Once the network scan has been performed, any AC15 connected to the network will appear and DSE Lite can connect to the drive by selecting it from the communications settings dropdown menu as shown above.

8.3 Manual Ethernet Configuration

To enable communications over the Ethernet an IP address must be set. With the default setting, an attempt at automatically obtaining an IP address will be made.

Note: The IP address will be obtained or modified when an Ethernet cable is connected or the inverter is powered-up.

The state of the Ethernet can be monitored using the parameter **0655 Ethernet State**.

The current IP settings of the inverter can be monitored using the following parameters:

- **0641 IP Address**
- **0642 Subnet Mask**
- **0643 Gateway Address**

The MAC address of the Ethernet port is fixed at the factory and can be read using the parameter **0646 MAC Address**

The IP address on the inverter may be set using the following methods:

- Manually to a fixed address
- Automatically by a DHCP server connected on the network
- Automatically by the inverter to a link-local address using Auto-IP (also known as Automatic Private IP Addressing)

The parameter **0640 Address method** controls how the IP address is set.

Manually Setting the IP Address

To set the IP address manually **0640 Address Method** must be set to Fixed. The IP address, subnet mask and gateway address will be set from the values in the parameters **0641 Set IP Address**, **0642 Set Subnet Mask**, **0643 Set Gateway Address**. If the network does not have a gateway to another network then the gateway address may be set to 0.0.0.0

These parameters may be set using the inverter keypad or optional 6901 keypad, in technician or engineer view.

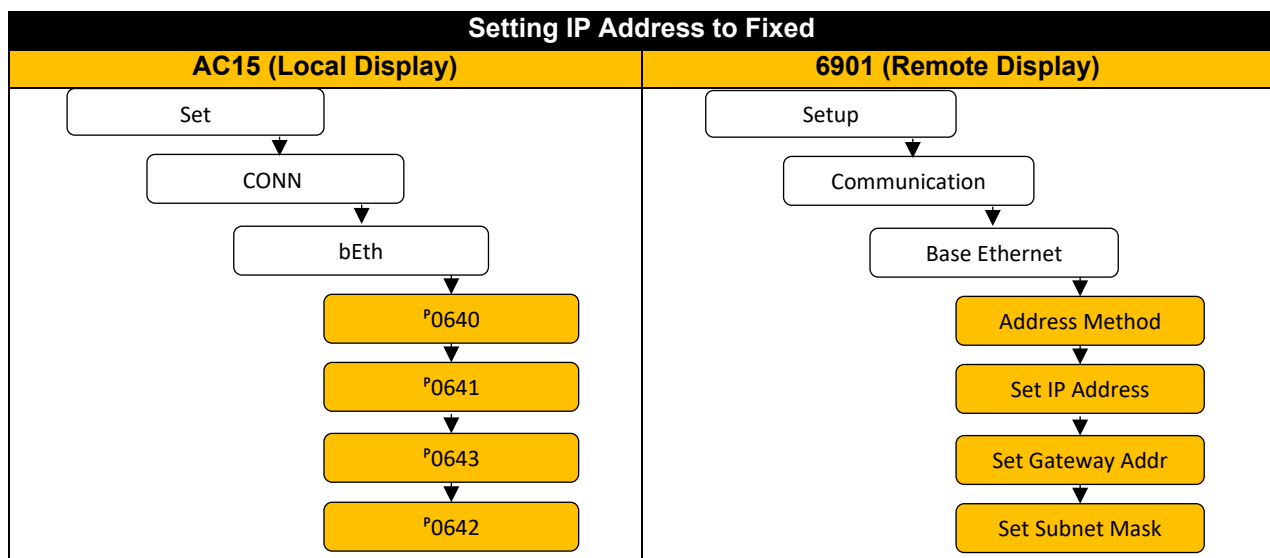

Automatically Assigning an IP Address using DHCP

Parameter	Setting	AC15 Keypad Display
0640 Address Method	Automatic	3

For Automatic Addressing, the DHCP is activated automatically. The IP address is then assigned by the DHCP server. The inverter will request an IP address, subnet mask and gateway address from the DHCP server.

If no DHCP server is discovered on the network, the inverter will take a link-local address in the range 169.254.*.*.

Note that the DHCP has precedence.

Automatically Assigning an IP Address using Auto-IP

Parameter	Setting	AC15 Keypad Display
0640 Address Method	Link Local	2

The inverter may assign itself a link-local address automatically using Link Local. This would be used where an automatic address is required but where no DHCP server is available, such as a small local network or when connecting an inverter directly to a PC (point to point).

The inverter will choose an IP address randomly from the link-local range **169.254.*.***. The drive checks that no other Ethernet device on the network is using the address before allocating it. The Inverter will store this IP address (in parameter **0644 Last Auto IP Address**) and attempt to use it next time Auto-IP is used. The gateway address is fixed to 0.0.0.0

8.4 Troubleshooting

The following diagnostic parameters are useful for monitoring the IP settings:

0651 IP Address

0652 Subnet Mask

0653 Gateway Address

The state of the Ethernet can be monitored using the parameter **0655 Ethernet State**, normal operation is when the state is **RESOLVED xx** (where xx is the address method, DHCP, Fixed etc).

If the connection has failed, check the parameter **0655 Ethernet State**

Parameter	Status	AC15 Keypad Display
0655 Ethernet State	Initialising	0
	No Link	1
	Resolving IP	2
	Resolved Fixed	3
	Resolved DHCP	4
	Resolved Auto IP	5
	Fault	6

No Link:

When the inverter Ethernet is connected to a network or other device, the Ethernet Link LED will be on and the Ethernet Activity LED will be flickering. If 'No Link' is reported, it is likely that the Ethernet cable is faulty or disconnected.

Resolving IP:

The inverter is waiting for a valid IP address to be set automatically, or manually using the parameters:

0641 Set IP Address

0642 Set Subnet Mask

0643 Set Gateway Address

Note that the IP address must be set to a non-zero value.

Fault:

An Ethernet loop has been detected. To clear the fault, break the loop by removing an Ethernet cable from one of the ports.

IP address is set but there is no communication:

If there is an IP address set but there are problems communicating with other devices (say a PC) then the IP address may not match the subnet on which it is connected. The range of the IP address permitted on a network depends upon the particular network. Normally if the IP address is obtained automatically then the settings will be correct for the network.

If connecting to a PC, the PC settings should also be checked – see the section *Changing the Ethernet settings on the PC*.

The administrator of a network should be aware of what IP settings are required.

When first connected, the inverter will attempt to determine the speed and duplex of the Ethernet link. This is done by using a method called auto-negotiation.

Some older hubs do not support auto-negotiation, in which case the inverter will use parallel detection. As parallel detection will only provide the link speed, the inverter will default to half-duplex.

Changing the Ethernet settings on the PC

Normally the PC Ethernet adapter is set to obtain an IP address automatically either from a DHCP server or using an automatic private IP address (Auto-IP). The adapter settings may be checked / modified as follows:

For Windows 7 / Windows 10 under Control Panel → Network And Sharing Center → Change adapter settings

Right-click on the required network adapter and choose Properties, then double-click on Internet Protocol Version 4 (TCP/IPv4).

To use a fixed IP address make sure Use the following IP address under the General tab is chosen and enter the required IP address, subnet mask and default gateway.

To use DHCP or Auto-IP make sure Obtain IP address automatically under the General tab is selected and under the Alternate Configuration tab that Automatic private IP address is selected.

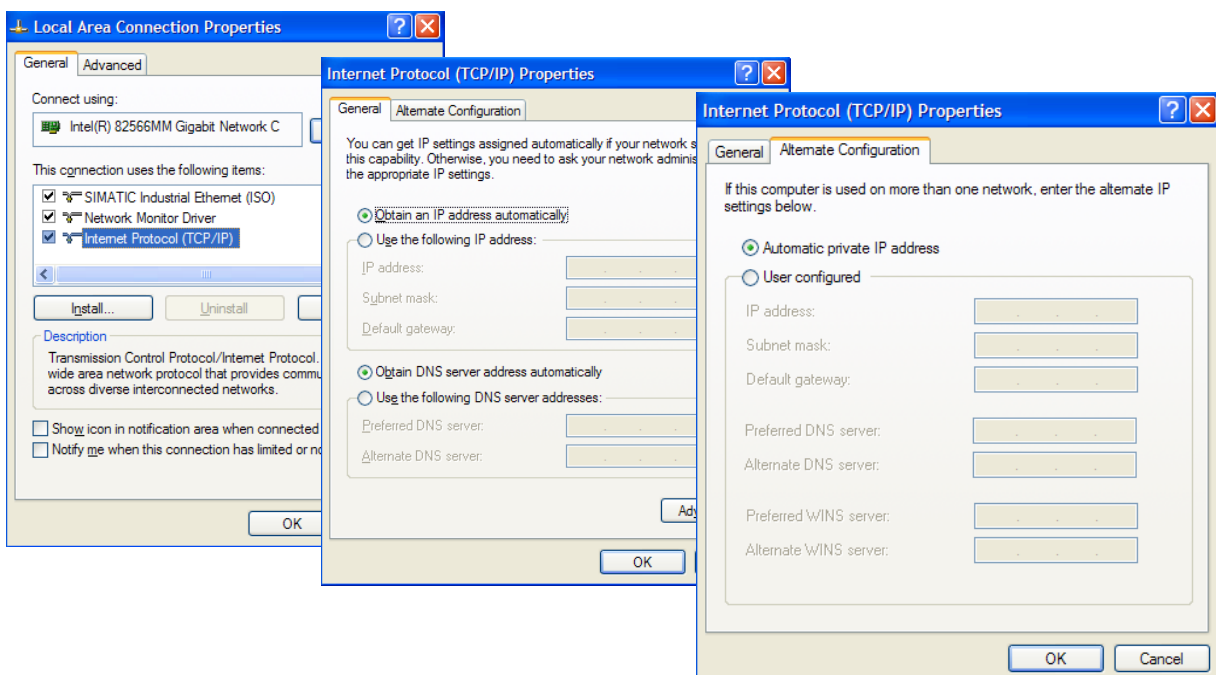

8.5 Connecting to the Webserver

The AC15 inverter has a built-in web server. To access the web server the parameter **0010 Web Access** must be set to **LIMITED** (default) or **FULL**. Full access is required for programming the AC15 through the web server.

Refer to the previous section for instruction on changing the IP address of the AC15, if required. Once the IP address is known, to access the inverter enter the IP address into a web browser. The following browsers are suitable:

- Mozilla Firefox
- Google Chrome
- Microsoft Edge

Web Pages

A number of built-in web pages can be accessed from the inverter.

Summary Page

The Summary page displays a summary of the inverter (basic drive identification parameters)

Parameters Page

The Parameters page provides access to the inverter parameters in a similar structure to the keypad. This page may only be accessed when the parameter **0010 Web Access** is set to FULL. The view level of the parameters may be modified using the parameter **0686 Web View Level**.

Parameters may be modified from this web page. If a parameter is successfully modified, and supports save, it will be saved if the parameter **0928 Enable Auto Save** is set to TRUE. If Enable Auto Save is set to FALSE then the Save button will appear in the parameter menu navigation bar. Pressing the Save button will save all parameters.

Some parameters may only be modified when in configuration mode, in which case the parameter number will be highlighted **orange**.

Some parameters may only be modified when the motor is stopped, in which case the parameter number will be highlighted **purple**.

It is recommended to use the refresh button provided on the parameter menu navigation bar, rather than on the browser itself, to view the latest parameter values.

Parameters may be continuously monitored by clicking on the “monitoring” button on the parameter menu navigation bar. It’s also possible to set the drive into configuration mode, which might be necessary for the access to some drive parameters.

If a web access password is set, this must be entered in the pop-up box on the browser to be able to gain full access to the web page. If the pop-up box is cancelled, then a read-only Parameters page will be shown.

If the inverter web page cannot be accessed then this may be due to the browser’s proxy server settings, especially if the PC has been used on a corporate network. To check the settings, access the Internet Options dialog from within the browser and click on the Connections tab, then click on LAN settings. Make sure the Proxy server checkbox is cleared, alternatively click on Advanced and add the IP address of the inverter to the Exceptions list.

Password Page

The password page allows for changing of the password of the webserver and the password for access via Modbus / DSE Lite, which is coupled to the Keypad password. Additionally, passwords for different access levels can be set.

By default, the password is cleared providing unrestricted access. The username is fixed to “ac15”.

- Basic Authenticate is a very low level of defence against unauthorized access. It is the responsibility of the system administrator to assess the network security and provide adequate protection.
- The username and password are case sensitive.
- If passwords are lost, they may only be cleared by a full parameter reset of the drive.

9 Programming Your Application

9.1 Macros

You can program the Inverter for specific applications.

The Inverter is supplied with macros (applications) which can be used as starting points for application-specific programming. This programming could simply involve the inputting of parameter values, or it may require the making or breaking of programmable links, which is a feature of the inverter.

Each application macro recalls a pre-programmed set of default parameters and links when it is loaded. Refer to APPENDIX C: Application Macros for further information.

9.2 Programming with Block Diagrams

Block diagram programming provides a visual method of planning the software to suit your application.

There are block diagrams provided at the end of this manual, each showing the software connections for an application macro. These pages replicate the DSE Lite programming screens. DSE Lite is Parker's drive programming tool.

The processes performed by a macro are represented as a block diagram, consisting of function blocks and links:

- Each function block contains the parameters required for setting-up a particular processing feature. Sometimes more than one instance of a function block is provided for a feature, i.e. for multiple digital inputs.
- Software links are used to connect the function blocks. Each link transfers the value of an output parameter to an input parameter of another (or the same) function block.

Each individual block is a processing feature, i.e. it takes the input parameter, processes the information, and makes the result available as one or more output parameters.

9.3 Programming Rules

The following rules apply when programming:

- A link's DESTINATION must be set to an input parameter (only one link per input parameter).
- A link's SOURCE may be set to any parameter. Both input and output parameters can be used as a source.
- Disable a link by setting both DESTINATION and SOURCE to NULL.
- Setting a link's SOURCE to be a feedback link forces the link to be executed first. This is used to reduce execution timing delays in a feedback loop situation.

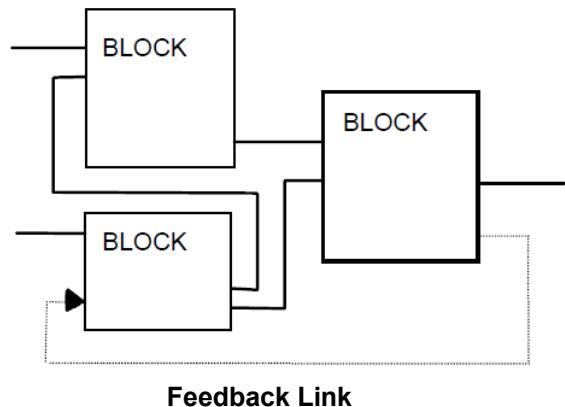

- When programming with DSE Lite, these rules will be obeyed automatically, and an error message will be displayed if an invalid connection is attempted.
- Function block input parameter values that receive their values from a link cannot be manually changed (as they will change back to the value they receive from the link when the Inverter is running).

9.4 Execution Rules

The complete block diagram is executed every 1ms. Just before a function block is executed, all the links that have that block as their destination are executed, thereby copying new values into the block's parameter inputs. The input parameters are then processed to produce a new set of output parameters. The execution order of the blocks is automatically arranged for minimal delay.

- The output value transferred by a link on execution is clamped to be between the maximum and minimum value for its destination input parameter.
- If a link's SOURCE and DESTINATION parameters have different decimal point positions, there is no automatic adjustment. Use a VALUE FUNCTION block to modify the input into the correct destination format.

9.5 Saving Your Modifications

If parameter values or links have been modified or a macro has been loaded, the new settings must be saved. The Inverter will then retain the new settings during power-down. By default, the inverter will automatically save any changes that are made. Refer to the function block CUSTOMISE MENUS for details on how to change this behaviour if a requirement for a manual parameter save is preferred.

9.6 Understanding the Function block Description

The following function blocks describe the parameter information necessary for programming the Inverter.

Input parameters are shown on the left-hand side, and output parameters are shown on the right-hand side of the block.

The keypad menu path diagrams assume that the keypad view level has been set to engineer and that the parameter is being accessed through the 'engineer' menu. If the view level is set to 'operator' or 'technician' the path to the parameter may be different.

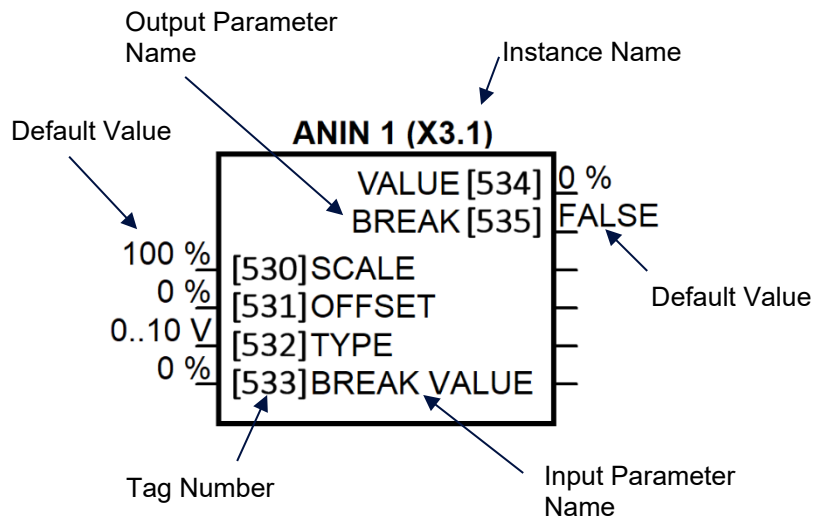

Instance name	Names the function block and keypad menu
Default value	The default value of the unmodified default macro: Macro 0
Input/Output Parameter Name	The name shown in DSE Lite
Tag Number	Unique identification used for communications, and for direct parameter access through the keypad

9.7 Function Blocks in Alphabetical Order

Anin 1 & Anin 2

Overview

The analog input block converts the input voltage or current into a value expressed as a percentage of a configurable range.

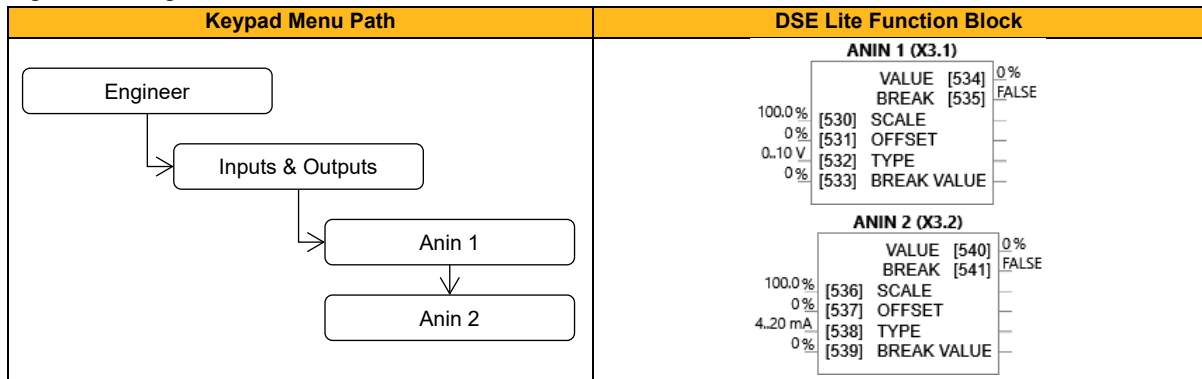

Functional Description

The input voltage is pre-processed and converted into a numeric value by the analog input electronics of the drive. The analog input function blocks further process this reading so that a value of 0.00% represents an input equal to the low input range, while a value of 100.00% represents an input equal to the high input range. The **SCALE** and **OFFSET** factors are then applied as shown to produce a value suitable for use in the application.

The break detect facility is only used in conjunction with the "4 to 20mA" hardware range. An input break is defined as an input reading less than either 0.1V or 0.45mA. When an input break has been detected, the **VALUE** output is forced to be the **BREAK VALUE**.

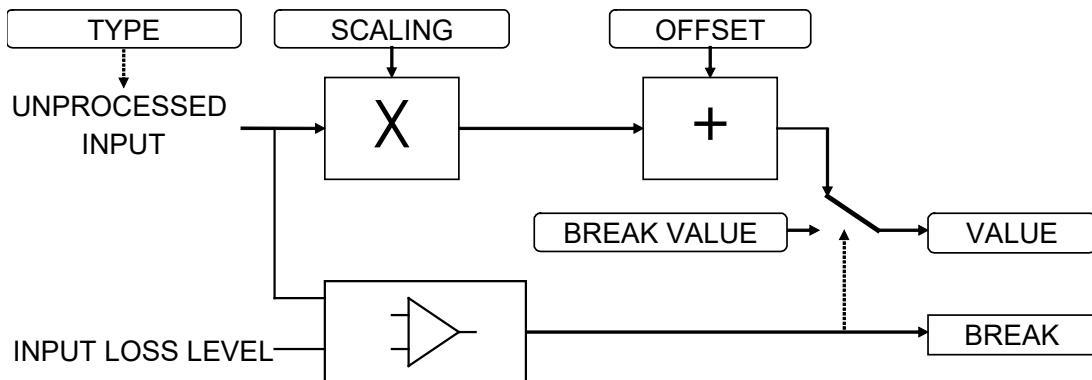

Anout 1, Anout 2 & Anout 3

Overview

The analog output block converts the demand percentage into a form suitable for driving the analog output electronics of the drive.

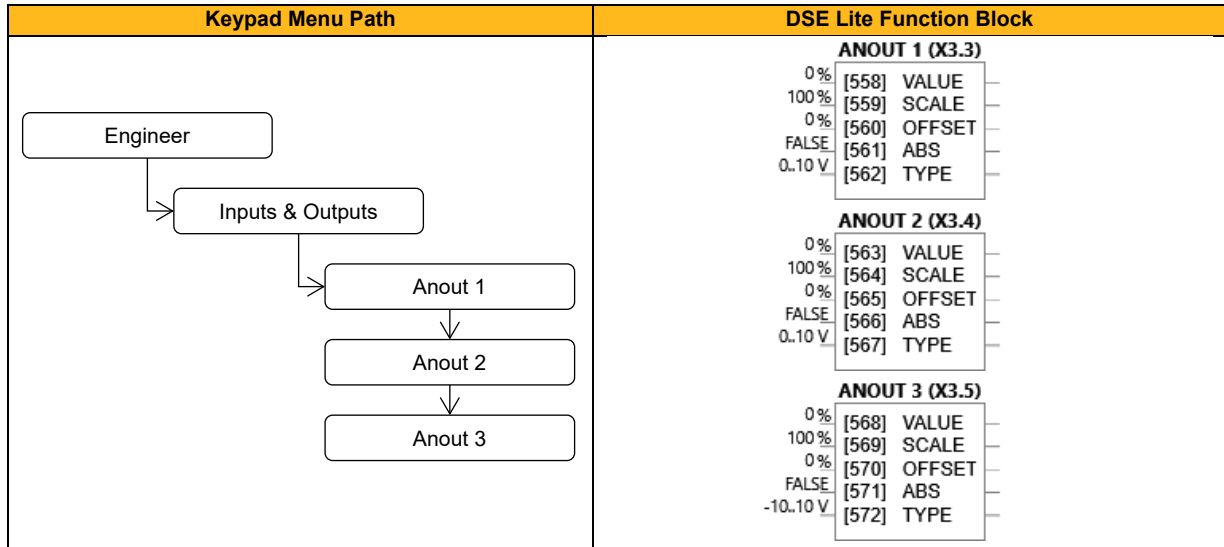

Function Block Inputs

Parameter Name	No.	Default Value	Range	Units	Type	Writable
VALUE						
ANOUT 1 (X3.3)	558	0	-300 ... 300	%	REAL	ALWAYS
ANOUT 2 (X3.4)	563	0	-300 ... 300	%	REAL	ALWAYS
ANOUT 3 (X3.5)	568	0	-300 ... 300	%	REAL	ALWAYS
Output Voltage of ANOUT = (Value * Scale/100%) + Offset (corresponding to 0...10V)						
SCALE						
ANOUT 1 (X3.3)	559	100	-300 ... 300	%	REAL	ALWAYS
ANOUT 2 (X3.4)	564	100	-300 ... 300	%	REAL	ALWAYS
ANOUT 3 (X3.5)	569	100	-300 ... 300	%	REAL	ALWAYS
A scaling factor to apply to VALUE. A scaling factor of 100.00% has no effect.						
OFFSET						
ANOUT 1 (X3.3)	560	0	-300 ... 300	%	REAL	ALWAYS
ANOUT 2 (X3.4)	565	0	-300 ... 300	%	REAL	ALWAYS
ANOUT 3 (X3.5)	570	0	-300 ... 300	%	REAL	ALWAYS
An offset added to VALUE after the scaling factor has been applied. An offset factor of 0.00% has no effect.						
ABS						
ANOUT 1 (X3.3)	561	FALSE			BOOL	ALWAYS
ANOUT 2 (X3.4)	566	FALSE			BOOL	ALWAYS
ANOUT 3 (X3.5)	571	FALSE			BOOL	ALWAYS
If true then the sign of the scaled output is ignored.						
TYPE						
ANOUT 1 (X3.3)	562	1: 0..10 V	0: -10..10 V 1: 0..10 V 2: 0..20 mA 3: 4..20 mA		ENUM	ALWAYS
ANOUT 2 (X3.4)	567	1: 0..10 V	0: -10..10 V 1: 0..10 V 2: 0..20 mA 3: 4..20 mA		ENUM	ALWAYS
ANOUT 3 (X3.5)	572	0: -10..10 V	0: -10..10 V 1: 0..10 V 2: 0..20 mA 3: 4..20 mA		ENUM	ALWAYS
Selects the output range (0V..10V / 0..20mA / 4..20mA).						

Functional Description

The scaling and offset parameters are applied to the demand value as shown.

If ABS is TRUE then the final output is the magnitude of value after being scaled and offset.

If ABS is FALSE then the final output will be limited to be within the range selected by TYPE.

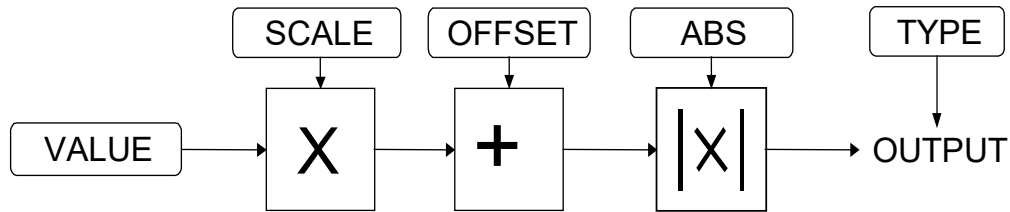

In the examples given:

- Analog output 1 is a unipolar type only (eg. 0V to +10V)
- Analog outputs 2 & 3 are bipolar types only (eg. -10V to +10V)
- Basic scaling is that 100% on the value parameter is equivalent to +10V on the analog output, and -100% is -10V
- Once the scale and offset are applied to the value parameter (the function block input) the result is clamped to +/-100% before being converted to an analog output
- If you select an unsupported type (eg. -10V to +10V for the unipolar Analog output 1) then the analog output will be fixed at 0V
- Setting a value of -100% to Analog output 1 (0V to +10V) with the absolute parameter set to True (default) gives an analog output of +10V
- Setting a negative % value to Analog output 1 with the absolute parameter set to False gives an analog output of 0V

App Config

Overview

Application Lock is used to prevent an accidental overwriting of the application macro by the user.

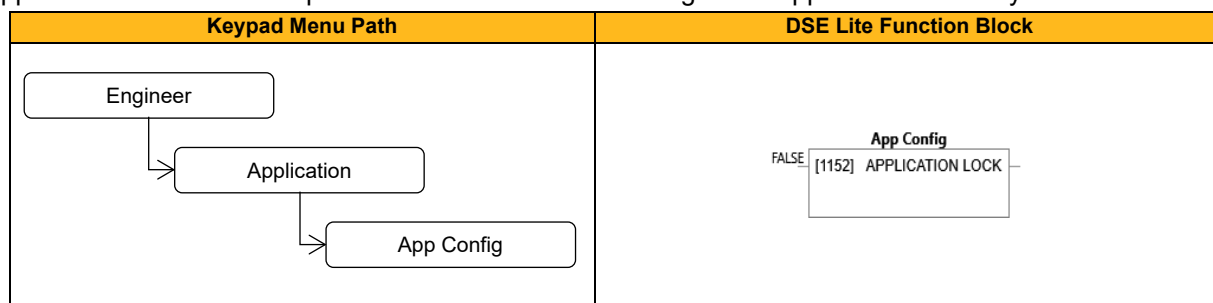

Function Block Inputs

Parameter Name	No.	Default Value	Range	Units	Type	Writable
APPLICATION LOCK	1152	FALSE			BOOL	ALWAYS
Set TRUE to prevent the application being over-written from the keypad.						

Functional Description

Application Lock does not prevent individual modification of parameters. Application lock prevents changing of the application macro from the drive keypad. The application macro selection cannot be made by the webserver or by keypad when set true. Downloading from DSE Lite or a clone file is still possible.

App Trips

Overview

Trips that can be triggered from the application.

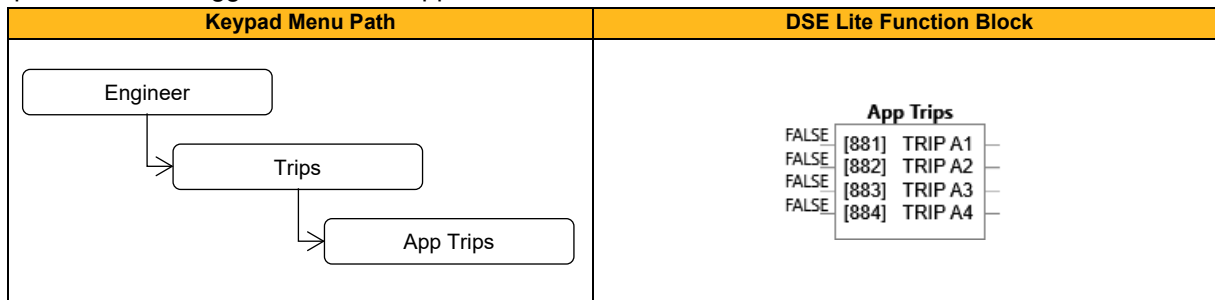

Function Block Inputs

Parameter Name	No.	Default Value	Range	Units	Type	Writable
TRIP A1	881	FALSE			BOOL	ALWAYS
Set TRUE to trigger trip A1.						
TRIP A2	882	FALSE			BOOL	ALWAYS
Set TRUE to trigger trip A2.						
TRIP A3	883	FALSE			BOOL	ALWAYS
Set TRUE to trigger trip A3.						
TRIP A4	884	FALSE			BOOL	ALWAYS
Set TRUE to trigger trip A4.						

Functional Description

These trips can be triggered in powered state and appear in the **0877 Trip Status Word High**

At Load

Overview

This function block is used to generate the **At or above load** signal that may be used as a digital output. If operating as an open-loop drive (V/F fluxing) it is important to enter the no-load current at rated speed into parameter **0175 Mag Current** (Induction Motor function block), otherwise **1174 Level** from this block could be inaccurate.

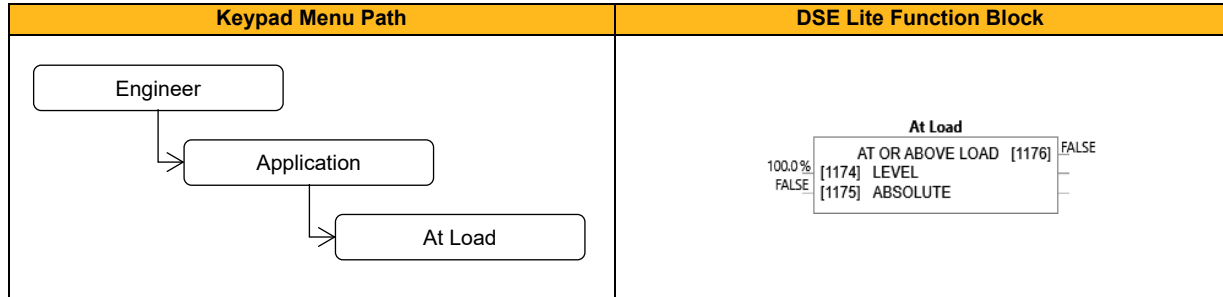

Function Block Inputs

Parameter Name	No.	Default Value	Range	Units	Type	Writable
LEVEL	1174	100.0	-300.0 to 300.0	%	REAL	ALWAYS
This parameter sets the value of load at which the AT OR ABOVE LOAD parameter becomes TRUE. 100% = rated torque for the motor.						
ABSOLUTE	1175	FALSE			BOOL	ALWAYS
When TRUE, the direction of rotation is ignored. In this case, the comparison level should always be positive. When FALSE, the direction of rotation is not ignored. Driving a load in the reverse direction gives a negative value for torque. In this case, the comparison level may be positive or negative.						

Function Block Outputs

Parameter Name	No.	Default Value	Range	Units	Type	Writable
AT OR ABOVE LOAD	1176	FALSE			BOOL	NOT
This parameter is TRUE if the load is equal to or above the value set by the LEVEL parameter.						

At Speed

Overview

This function block is used to generate the **At Speed** signal that may be used as a digital output .

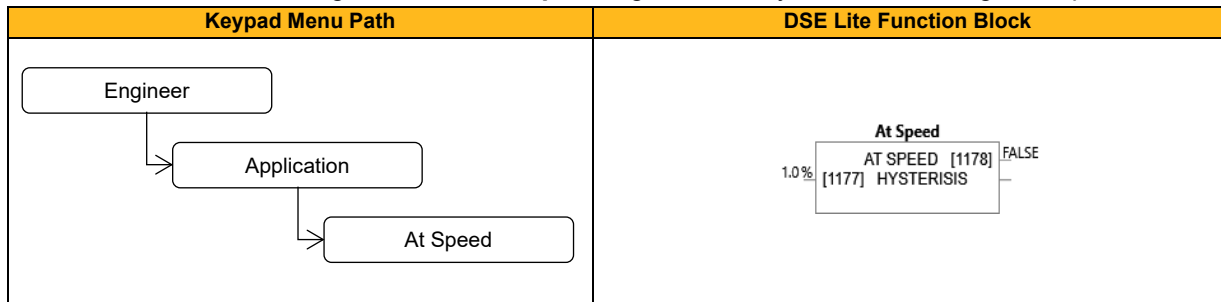

Function Block Inputs

Parameter Name	No.	Default Value	Range	Units	Type	Writable
HYSTERESIS	1177	1.0	0.0 to 300.0	%	REAL	ALWAYS
Provides a hysteresis band about the Speed Setpoint in which the At Speed output is stable.						

Function Block Outputs

Parameter Name	No.	Default Value	Range	Units	Type	Writable
AT SPEED	1178	FALSE			BOOL	NOT
This parameter is TRUE when the speed demand is within the hysteresis band.						

Functional Description

The Speed Setpoint is shown by the Speed Setpoint (%) diagnostic in the Diagnostics menu, which is shown as a percentage of the MAX SPEED parameter (Hz).

As long as the speed demand value stays in the hysteresis band around the Speed Setpoint, the **At Speed** output is stable. When speed is exceeding this band, the output is set to FALSE.

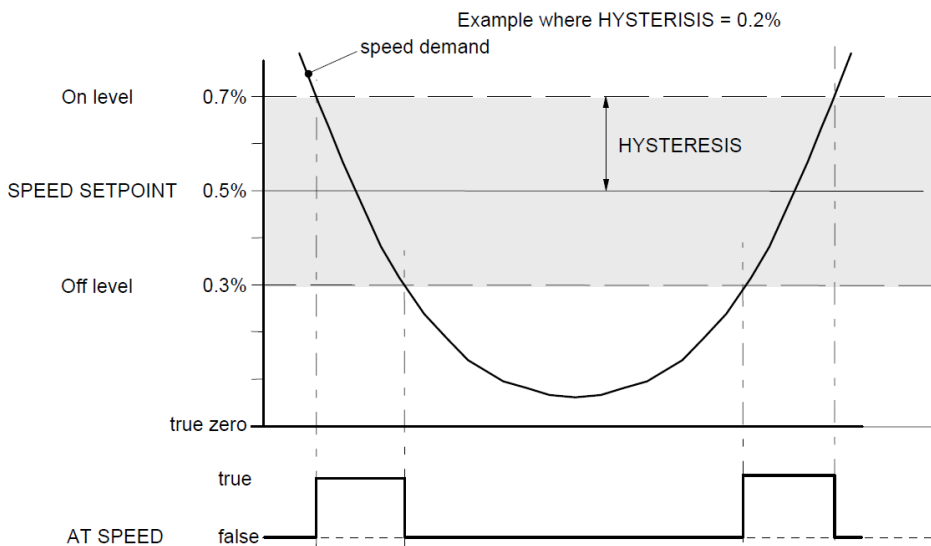

Functional Description

The Auto Circulate function is intended for use with fan or pump applications to automatically cycle through up to 8 run cycles. Alternatively, it may be used as a multi-stage timer for other applications. The **Stage** output of the function should be connected to the **Stage Select** input of the **Multi-Stage Speed** function block. The **Run** output should be connected to the **Run Forward** input of the **Sequencing block**. The **Cycle** output is used as an indication of the number of elapsed cycles.

For example, If 8 stages are required, and all 8 stages are required to run twice, the **Stages** should be set to 8, the Number of **Cycles** set to 2. The **Running Time** and **Stop Time** can be set for each stage separately. To continue running at the end of all cycles, input **Keep Running** should be set true. If false, the **Run** output will go false once the last stage of the final cycle is complete.

Auto Restart

Overview

The Auto Restart feature provides the facility to automatically reset a choice of trip events and restart the drive with a programmed number of attempts. The number of attempted restarts is monitored. A manual or remote trip reset is required if the drive is not successfully restarted within the maximum number of restarts. The purpose of this feature is to allow automatic recovery from trip conditions. This is especially useful on remote or unmonitored sites.

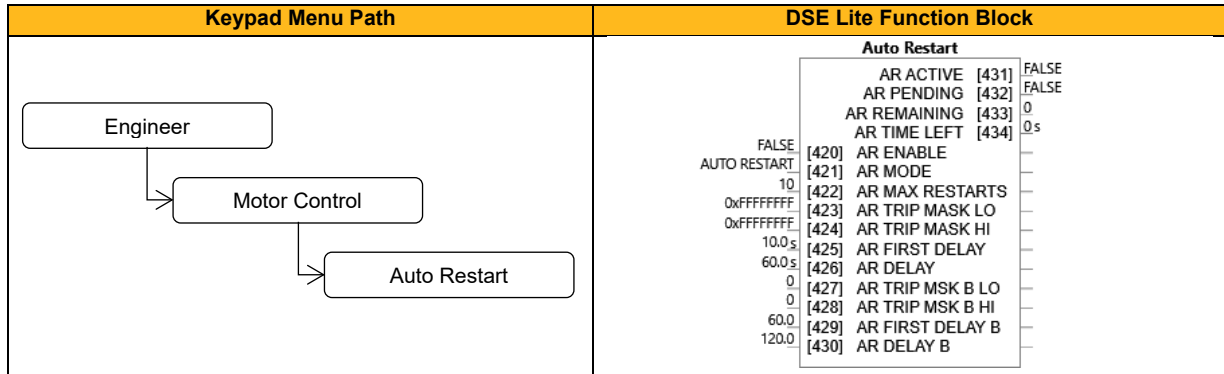

Function Block Inputs

Parameter Name	No.	Default Value	Range	Units	Type	Writable
AR ENABLE	420	FALSE			BOOL	ALWAYS
Enables the Auto Restart function.						
AR MODE	421	1: Auto Restart	0: Trip Reset 1: Auto Restart 2: Auto Start		ENUM	ALWAYS
Defines the mode of operation of the auto restart function: Trip reset only, standard auto restart or extended auto start.						
AR MAX RESTARTS	422	10	1 to 20		USINT	ALWAYS
Defines the maximum number of restart attempts before permitted, before the AR function is disabled automatically and an external intervention will be required.						
AR TRIP MASK LO	423	0xFFFFFFFF	0: 01 Over Voltage 1: 02 Under Voltage 2: 03 Stack Over I 3: 04 Over Current 4: 05 Current Lim 5: 06 Motor Stall 6: 07 Inverse Time 7: 08 Motor I2t 8: 09 Low Speed I 9: 10 Heatsink Temp 10: 11 Internal Temp 11: 12 Motor Temp 12: 13 Dynamic Brake 13: 14 Digout Load 14: 15 Anin 1 Over 15: 16 Anin 2 Over 16: 17 Contactor 17: 18 Phase Fail 18: 19 Output Phase 19: 20 Vdc Ripple 20: 21 Pwr Loss Stop 21: 22 Overspeed 22: 23 PMAC Speed 23: N/A 24: 25 Speed Error 25: N/A 26: 27 Command Loss 27: 28 Comms Break 28: 29 Base Modbus		DWORD	ALWAYS

			29: 30 Fieldbus 30: 31 STO Active 31: 32 External Trip			
Defines the trip events, that can trigger the auto restart sequence (together with AR Trip Mask High).						
AR TRIP MASK HI	424	0xFFFFFFFF	0: 33 A1 1: 34 A2 2: 35 A3 3: 36 A4 4: 37 CPU Loading		DWORD	ALWAYS
Defines the trip events that can trigger the auto restart sequence. Use in conjuncture with AR Trip Mask and AR Delay.						
AR FIRST DELAY	425	10.0	0.0 to 3600.0	s	TIME	ALWAYS
Delay before the drive is restarted following the first time the drive is tripped. The delay time is started once all trips have become inactive.						
AR DELAY	426	60.0	0.0 to 3600.0	s	TIME	ALWAYS
Delay before the drive is restarted following the second and subsequent trip. The delay time is started once all trips have become inactive.						
AR TRIP MSK B LO	427	0: 0	Refer to AR Trip Mask Lo – P0423		DWORD	ALWAYS
Defines the trip events, that can trigger the auto restart sequence (together with AR Trip Mask B High).						
AR TRIP MSK B HI	428	0: 0	Refer to AR Trip Mask Hi – P0424		DWORD	ALWAYS
Defines the trip events that can trigger the auto restart sequence. Use in conjuncture with AR Trip Mask B and Delay B.						
AR FIRST DELAY B	429	60.0	0.0 to 3600.0		TIME	ALWAYS
Delay before the drive is restarted following the first time the drive is tripped (associated with Mask B). The delay time is started once all trips have become inactive.						
AR DELAY B	430	120.0	0.0 to 3600.0		TIME	ALWAYS
Delay before the drive is restarted following the second and subsequent trip (associated with Mask B). The delay time is started once all trips have become inactive.						

Function Block Outputs

Parameter Name	No.	Default Value	Range	Units	Type	Writable
AR ACTIVE	431	FALSE			BOOL	NOT
Indicates that the auto restart module has a pending trip reset or drive restart.						
AR PENDING	432	FALSE			BOOL	NOT
Indicates that the motor will restart once all trip sources have become inactive and the delay timer has expired.						
AR REMAINING	433	0	0 to 20		USINT	NOT
Count of remaining restart attempts permitted until AR feature is disabled and an external intervention will be required.						
AR TIME LEFT	434	0	0.0 to 3600.0	s	TIME	NOT
Time until drive restart will be attempted. The countdown is started, once all trip sources are inactive.						

Functional Description

The AR feature can be configured to operate in one of three modes via the parameter **0421 AR Mode**. In all modes the AR feature becomes active when the drive trips on one of the trips selected by one of the Trip Mask parameters. If the drive trips due to a trip not selected in one of these parameters the AR feature will remain in the idle state. Setting parameter **0420 AR Enable** to FALSE will disable the AR feature regardless of its current state.

0421 AR Mode 0: Trip Reset

In Trip Reset mode, once the AR feature becomes active it monitors all possible trip sources. Once all trip sources are inactive the AR feature will attempt to reset the trip event, moving the Sequencing State from the FAULTED state. The AR feature resets the trip as soon as possible, it does not wait for either **0425 AR First Delay** or **0426 AR Delay**. In this mode the AR feature will not attempt to restart the motor.

This mode may be used when an external supervisory system is monitoring the Faulted bit in **0507 Status Word**. This bit will be cleared once all trip sources are inactive and the trip has been successfully cleared, indicating that the drive may be started.

**0421 AR Mode 1: Auto Restart**

Caution: when Auto Restart is selected the motor may run unexpectedly.

In Auto Restart mode, once the AR feature becomes active it monitors all possible trip sources. Once all trip sources are inactive the AR feature starts the programmed delay. Once the delay timer expires the AR feature attempts to reset the trip and to restart the motor.

The AR feature will not restart the motor if it was not running at the time of the trip, nor will it restart the motor if the run signal has been removed at any time since the trip, (even if it is subsequently re-applied). When a motor restart will not be attempted the AR feature will act as if it had been configured for **Trip Reset** only. If a motor restart will be attempted the parameter **0432 AR Pending** is set TRUE.

Each time a restart is attempted the value in **0433 AR Remaining** is decremented. Once this value reaches zero, any further trip selected for auto restart will cause the AR feature to disable itself.

**0421 AR Mode 2: Auto Start**

Caution: when Auto Start is selected the motor may run unexpectedly.

In Auto Start mode, once the AR feature becomes active it monitors all possible trip sources. Once all trip sources are inactive the AR feature starts the programmed delay. Once the delay timer expires the AR feature attempts to reset the trip and to restart the motor.

The AR feature will attempt to start the motor even if it was not running at the time of the trip, as long as the Sequencing Logic parameter **0506 Control Word** is configured to run, (typically bits 0, 1, 2 and 3 all set). In this mode the parameter **0432 AR Pending** is set TRUE. Each time a restart is attempted the value in **0433 AR Remaining** is decremented. Once this value reaches zero, any further trip selected for auto restart will cause the AR feature to disable itself.

Recovery from Self Disabled state

The AR feature will remain in the Self Disabled state indefinitely. It may be re-activated by the trip condition being reset by some other means, (ie. Manually by pressing the stop key on the HMI, or remotely using trip reset). Alternatively, the AR feature may be re-enabled by setting **0420 AR Enable** to FALSE then back to TRUE.

Indication

When the AR feature is activated the parameter **0431 AR Active** is set TRUE.

While a restart is pending the parameter **0432 AR Pending** is set TRUE. Where fitted, the green LED illuminating the run key on the HMI will flash.

All indicators are reset once the restart, (or trip reset), attempt has been completed or if the AR feature is disabled.

Autotune

Overview

The Autotune is an automatic test sequence performed by the inverter to identify motor model parameters. The motor model is used by the Sensorless Vector and Closed-Loop Vector control modes. You **MUST** perform an auto-tune before operating the inverter in either of the Vector control modes.

If the control mode is set to Open Loop (V/Hz) mode an autotune is not necessary. The selection of Vector Control mode or Open Loop mode is determined by the parameter 0031 (Control Strategy) in the Control Mode function block. Induction motor nameplate parameters must be entered before running the autotune procedure for the drive to correctly measure motor model parameters.

The motor must be allowed to spin freely during a rotating autotune. It is acceptable for the motor to be connected to a load, provided that the load is purely inertia, with negligible friction, and does not require the motor to produce torque in order to turn.

If there are practical difficulties performing rotating autotune with fully free motor shaft (e.g., gearbox, pump, compressor, lift, etc., already mounted) then **stationary autotune** is to be attempted. However, if (with both below variants) the obtained set of values does not result in a full, smooth speed or torque control, or if it isn't even sufficient to rotate the motor at all, a rotating autotune has to be performed.

It is also recommended that this stationary autotune is not used for the motors above 30kW.

If operation above base speed in the field weakening region is required, a rotating autotune needs to be performed.

The default method of stationary autotune requires a value for magnetizing current to be entered into parameter **0037 Atn Mag I MOTOR**, as this method provides more reliable but less accurate results. The calculation for magnetizing current is:

Motor nameplate rated current (Parameter 0222) * sqrt (1- motor nameplate power factor (Parameter 0228)²).

For example, if the motor nameplate rated current is 6A, and the power factor is 0.72, magnetizing current can be calculated as $6 * (1 - 0.72^2) = 2.89A$

2584 Atn Mag I UsrEna enables or disables automatic calculation of magnetizing current by the inverter during stationary autotune. If set to TRUE (default), **0037 Atn Mag I Motor** defines the motor magnetizing current. The user must enter the calculated motor magnetizing current into this parameter before proceeding with the stationary autotune.

If **2584 Atn Mag I UsrEna** is set to FALSE, an advanced test procedure will be invoked that attempts to calculate all the necessary motor model parameters (including magnetizing current) from injected tests signals without rotation.

If a permanent magnet motor is used and there is no datasheet available from your motor provider, you **MUST** perform an autotune before operating the inverter in the Vector control mode. Before running the autotune, some PMAC Motor parameters should be set. These should be obtained from the motor nameplate:

- **0279 PMAC Max Speed**: motor rated speed
- **0281 PMAC Rated Cur**: motor rated current
- **0282 PMAC Rated Torq**: motor rated torque
- **0290 PMAC Base Volts**: motor voltage
- **0280 PMAC Max Current**: motor max current (if not known, set it to the same value as **0281 PMAC Rated Cur**)
- **0283 PMAC Motor Poles**: motor number of poles (must be an even number)
- **0288 PMAC Mot Inertia**: motor inertia : (try to set a good estimated value, the speed loop will use it for setting correct control parameters)

If a permanent magnet motor is used and there is a datasheet available from your motor provider, you should enter the required motor parameters from the datasheet.

If a permanent magnet motor is used, setting the **0267 Stack Frequency** to 4kHz or less will help to better estimate the motor resistance (**0285 PMAC Winding Resistance**).

For best results it is better to carry out the autotune at the maximum speed that is likely to be required. If an autotune is run at a particular speed, the motor characteristics will be measured up to this speed and estimated above this speed. If you later discover that you need to run the motor faster than this, you can run up to twice the speed at which the autotune was performed, but the control may not be as good in this region, therefore it is preferable to run another autotune at the higher speed. If you wish to run the motor at more than twice the speed at which the autotune was performed, as second autotune is necessary. If in doubt, the autotune speed is recorded in the parameter **0044 Autotuned Speed** for reference, as described below.

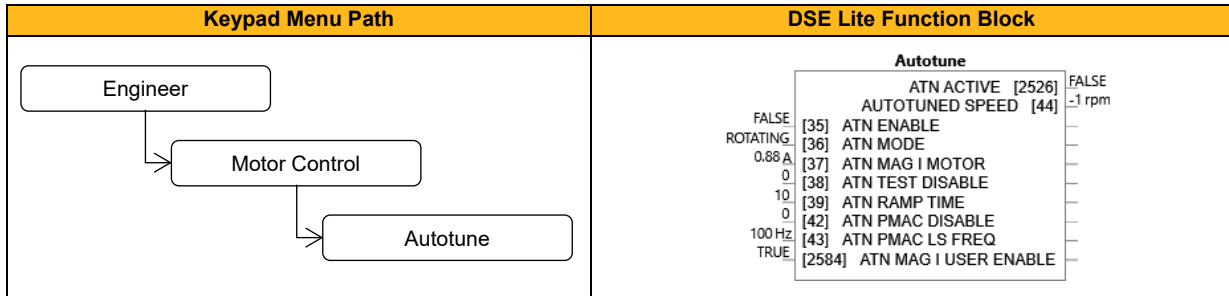

Function Block Inputs

Parameter Name	No.	Default Value	Range	Units	Type	Writable
ATN ENABLE	35	FALSE			BOOL	STOPPED
Puts the autotune module into a state where it will carry out the autotune when the drive is started.						
ATN MODE	36	1: Rotating	0: Stationary 1: Rotating		ENUM	STOPPED
Selects whether the autotune is carried out on a rotating motor or whether it is done on a stopped motor (stationary). It may be necessary to carry out a stationary autotune if the motor is not free to rotate, for example if it is already connected to a machine. Use the more accurate rotating autotune where possible. P2584 'Atn Mag I UsrEna' defines the method of stationary autotune.						
ATN MAG I MOTOR	37	Stack dependent	0.01 to 1000	A	REAL	STOPPED
Value of magnetizing current entered by the user. Used for stationary autotune as input for the magnetizing current parameter in the Induction Motor Data if P2584 'Atn Mag I UsrEna' is set true. If available the value can be taken from the motor nameplate or datasheet, if not available and estimation for this parameter is motor nameplate_rated_current (P222) * sqrt(1-nameplate_powerfactor(P228) ²). The parameter is preset according to this formula using the inverter size dependent defaults for P222 and P228.						
ATN TEST DISABLE	38	0: 0	Bit 0: Leakage Inductance Bit 1: Stator Resistance Bit 2: Magnetizing Current Bit 3: Rotor Time Constant Bit 4: Encoder Direction		WORD	STOPPED
For induction motors: Allows selected tests to be disabled (bitwise) - per default all tests are carried out.						
ATN RAMP TIME	39	10	1 to 1000		TIME	STOPPED
Sets the ramp up time to base speed during autotune.						
ATN PMAC DISABLE	42	0: 0	Bit 0: Leakage Inductance Bit 1: Stator Resistance Bit 2: KE Constant		WORD	STOPPED
For PMAC motors: Allows selected tests to be disabled (default all tests are carried out).						
ATN PMAC LS FREQ	43	100	0 to 500	Hz	REAL	STOPPED
Test frequency applied to the motor to determine leakage inductance.						
ATN MAG I USER ENABLE	2584	TRUE			BOOL	STOPPED
Switch to use user define magnetization current given via P0037 'Atn Mag I Motor ' instead of performing the dedicated stationary measurement sequence. Default is TRUE - a user defined magnetization current needs to be provided on P0037. Setting FALSE might give a better result (lower, more correct magnetizing current) however if stationary autotune fails with this setting, revert ATN MAG I USER ENABLE to true, and enter a calculated value for magnetizing current.						

Function Block Outputs

Parameter Name	No.	Default Value	Range	Units	Type	Writable
ATN ACTIVE	2526	FALSE			BOOL	NOT
A diagnostic output indicating whether the autotune sequence is active.						
AUTOTUNED SPEED	44	-1	-1 to 100000	rpm	REAL	NOT
Records the value of "100% speed in rpm" parameter at the time the autotune was carried out.						

Functional Description

IMPORTANT

You **MUST** carry out an Autotune if you intend to use the inverter in vector control mode. If using Volts/Hz control an Autotune is not necessary.

Autotune can only be initiated from the "stopped" condition. When the test is complete, the stack is disabled and **0035 Atn Enable** is set to FALSE.

Rotating Autotune

If an induction motor is fitted, the autotune will identify parameters as follows.

Parameter	Description	Note
Mag Current	Magnetising current	Not measured by Stationary Autotune
Stator Res	Per phase stator resistance	
Leakage Induct	Per phase stator leakage inductance	
Mutual Induct	Per phase mutual inductance	
Rotor Time Const	Rotor time constant	This will be identified while the motor is spinning, while measuring the magnetizing current. If stationary autotune is selected, it will be identified from magnetizing current and motor nameplate rpm

- The autotune sequence rotates the motor up to the user-programmed **0457 Max Speed** in order to identify these parameters. A rotating autotune is required if the motor is to be operated above base speed.

If a permanent magnet motor is fitted, the autotune will identify parameters as follows.

Parameter	Description	Note
Stator Res	Phase to phase stator resistance	
Leakage Induct	Phase to phase stator leakage inductance	
Back EMF Ke	Back-emf constant	This will be identified while the motor is spinning. If stationary autotune is selected, it will be identified from motor nameplate parameters

- The autotune sequence rotates the motor up to the half of the rated motor speed in order to identify these parameters.

Autotune Alerts

If the autotune fails to complete for any reason, an alert will be displayed and the autotune abandoned.

Possible alerts are as follows:

Trip Name	Possible Reason for Trip	Criteria for Warning
Leakage Time Err	The autotune has attempted to determine the leakage inductance of the motor but cannot make the required test current.	Problem with motor connection.
Motor Turning Err	The autotune is trying to find the encoder direction by spinning the motor, but the motor is already spinning.	Wait till the motor stops.
Neg Slip Freq	Autotune has calculated a negative slip frequency, which is not valid. Nameplate rpm may have been set to a value higher than the base speed of the motor.	Check nameplate rpm, base frequency, and pole pairs are correct.
Tr Too Large	The calculated value of rotor time constant is too large.	Check the values of Nameplate Speed and Base Frequency.
Tr Too Small	The calculated value of rotor time constant is too small.	Check the values of Nameplate Speed and Base Frequency.
Max Speed 2 Low	During Autotune the motor is required to run at the nameplate speed of the motor. If 100% Speed in RPM parameter limits the speed to less than this value, an error will be reported.	Increase the value of Max Speed parameter 0457 up to the nameplate rpm of the motor (as a minimum). It may be reduced, if required, after the Autotune is complete.
Supply Volts Low	The autotune will compensate for low supply volts, down to 70% of motor rated volts. Below this value it will stop the autotune and raise an alert.	Re-try when mains volts are within specification.
Not At Speed	The motor was unable to reach the required speed to carry out the Autotune.	Possible reasons include: motor shaft not free to turn; the motor data is incorrect.
Mag I Err	It was not possible to find a suitable value of magnetizing current to achieve the required operating condition for the motor.	Check the motor data is correct, especially nameplate rpm and motor volts. Also check that the motor is correctly rated for the drive.
Ke Too Large	Ke value calculated during the autotune (stationary) is too large (the max value is 840V)	Check the motor data is correct, especially nameplate rpm, rated amps and motor volts. If low speed motor with a Ke value higher than 840V, enter by hand the corresponding value after the autotune completion.
Ke Too Small	Ke value calculated during the autotune (stationary) is too small (the min value is 1V)	Check the motor data is correct, especially nameplate rpm, rated amps and motor volts.
Tests Disabled	All auto tune tests are disabled	Check parameter 0038: Atn Test Disable and parameter 0042: Atn PMAC Disable

Brake Control

Overview

This is used to control electromechanical motor brakes in hoist and lift applications.

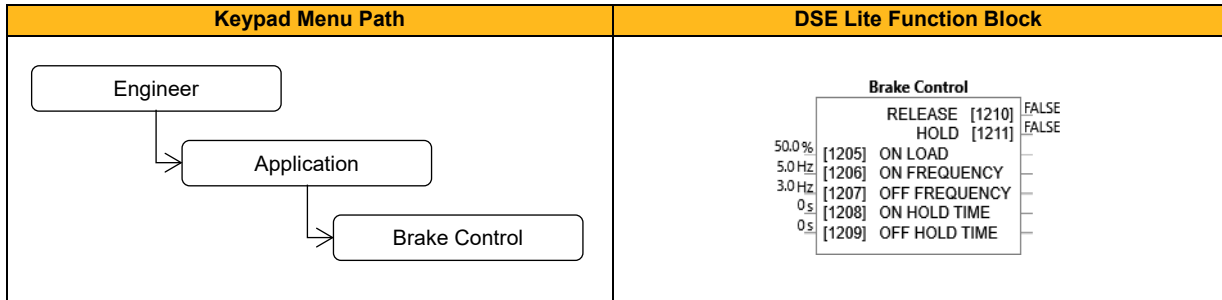

Function Block Inputs

Parameter Name	No.	Default Value	Range	Units	Type	Writable
ON LOAD	1205	50.0	0.0 to 150.0	%	REAL	ALWAYS
Load level at which the external motor brake is released.						
ON FREQUENCY	1206	5.0	0.0 to 500.0	Hz	REAL	ALWAYS
Frequency at which the external motor brake is released.						
OFF FREQUENCY	1207	3.0	0.0 to 500.0	Hz	REAL	ALWAYS
Frequency at which the external motor brake is applied.						
ON HOLD TIME	1208	0	0.0 to 300.0	s	REAL	ALWAYS
Sets the duration of the pulse output on HOLD when RELEASE becomes TRUE.						
OFF HOLD TIME	1209	0	0.0 to 300.0	s	REAL	ALWAYS
Sets the duration of the pulse output on HOLD when RELEASE becomes FALSE.						

Function Block Outputs

Parameter Name	No.	Default Value	Range	Units	Type	Writable
RELEASE	1210	FALSE			BOOL	NOT
Boolean output providing a signal to operate the brake delay.						
HOLD	1211	FALSE			BOOL	NOT
Becomes TRUE when the brake is toggled On or Off, remains TRUE for duration set by OFF HOLD TIME or ON HOLD TIME.						

Functional Description

The operation of the Brake Control feature is illustrated below.

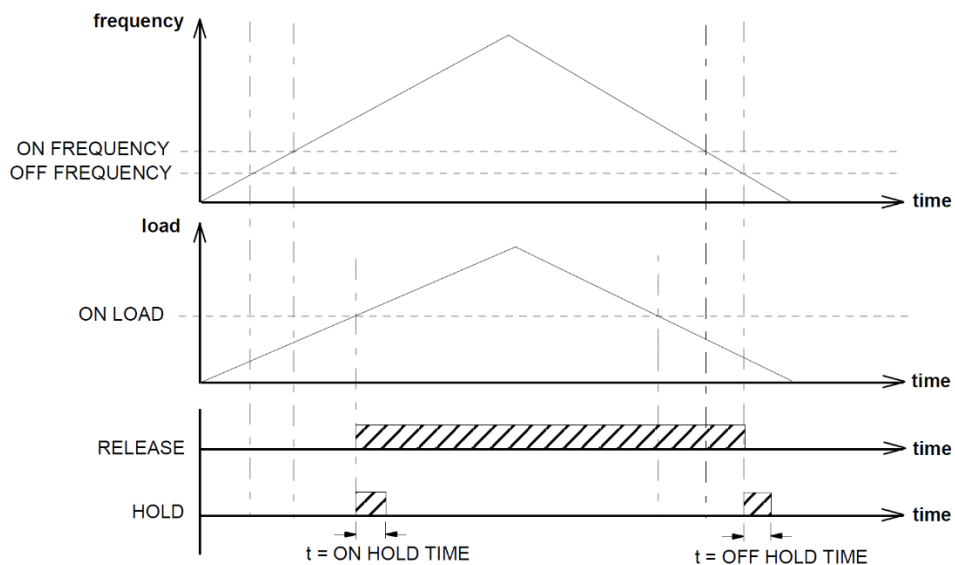

Braking

Overview

The braking function block controls the rate at which energy from a regenerating motor is dumped into a resistive load. This dumping prevents the dc link voltage reaching levels which would cause an Overvoltage trip.

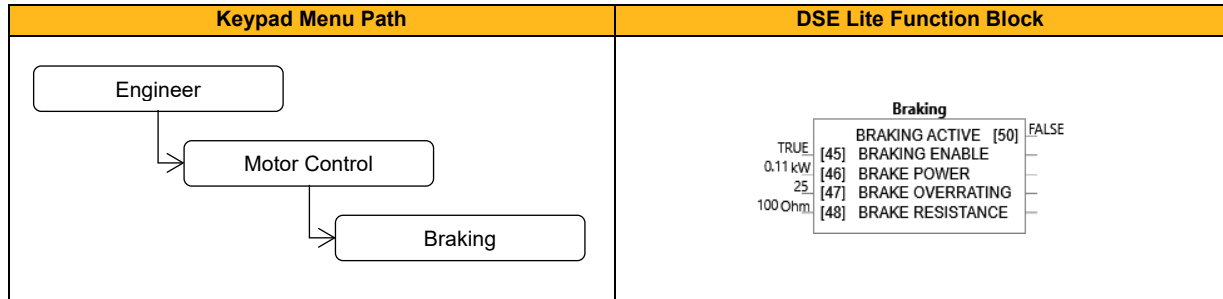

Function Block Inputs

Parameter Name	No.	Default Value	Range	Units	Type	Writable
BRAKING ENABLE	45	TRUE			BOOL	ALWAYS
Enables operation of the dynamic braking feature.						
BRAKE POWER	46	0.11	0.1 to 510	kW	REAL	STOPPED
The power that the brake load resistor may continually dissipate. Default value is the recommended power rating for the used drive size.						
BRAKE OVERRATING	47	25	1 to 40		REAL	STOPPED
Multiplier that may be applied to Brake Power for power overloads lasting no more than 1 second.						
BRAKE RESISTANCE	48	100	0.01 to 1000	Ohm	REAL	STOPPED
The resistance value of the dynamic brake load resistor. The default setting is the minimum permissible resistance for the used drive size (this value results in the highest possible peak braking power, a resistor with a lower resistance value must not be connected).						

Function Block Outputs

Parameter Name	No.	Default Value	Range	Units	Type	Writable
BRAKING ACTIVE	50	FALSE			BOOL	NOT
A read-only parameter indicating the state of the brake switch.						

Functional Description

When enabled, the Braking block monitors the internal dc link voltage every milli-second and sets the state of the brake switch accordingly.

The dynamic braking block provides a control signal that is used by the Slew Rate block. This causes the setpoint to be temporarily frozen whenever the dynamic brake is operating because the dc link voltage exceeds the internal comparison level. This allows the stop rate to be automatically tuned to the characteristics of the load, motor, inverter and brake resistor.

The Braking block operates even when the motor output is not enabled. This allows the block to continually monitor the energy dumped into the braking resistor, and the energy dissipated across the brake switch.

With this information the inverter is able to deduce the loading on the brake resistor. Optional trips may be enabled should the switch or resistor be loaded beyond its capabilities.

Refer also to the Installation Product Manual – Dynamic Braking.

Clone

Overview

The clone feature allows the drive configuration (application and parameters) to be saved to an SD card and subsequently loaded to the same or a different drive.

All parameters fall into one of the following cloning categories listed in the parameter table at the end of the software manual:

- **Never:** This type of parameter will never be copied to a new drive. This category includes parameters that are not saved and parameters that contain information such as runtime statistics.
- **Drive Unique:** This type of parameter is normally unique to the drive, such as the drive name, drive unique parameters are written in Full Restore Mode
- **Power:** This type of parameter is related to the power stack of the drive or to the motor connected to the drive, these parameters are cloned in Full Restore Mode or if set in Partial Install Mode
- **Other:** Any saved parameter that is not in the other cloning categories. This category includes the majority of parameters including the application parameters.

The visibility of the following cloning parameters on the HMI may depend on the selection of other cloning parameters and whether an SD card is fitted.

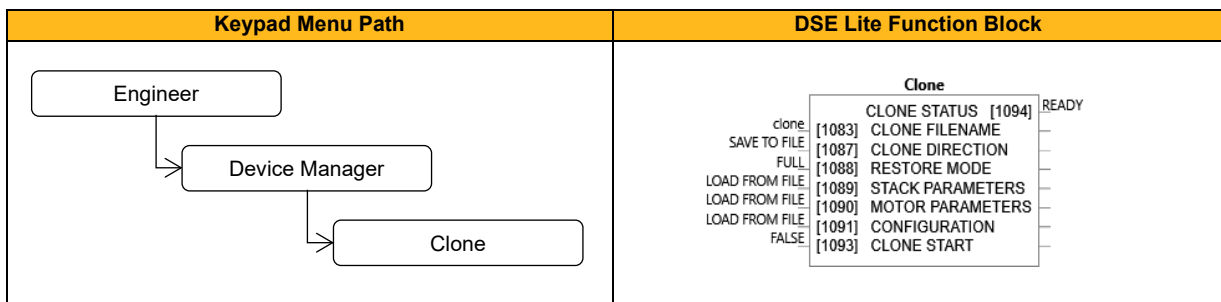

Function Block Inputs

Parameter Name	No.	Default Value	Range	Units	Type	Writable
CLONE FILENAME	1083	clone			STRING	ALWAYS
Filename for clone file.						
CLONE DIRECTION	1087	0: Save To File	0: Save To File 1: Load From File		ENUM	ALWAYS
Selects between creating a new clone file or loading data from an existing clone file.						
RESTORE MODE	1088	0: Full	0: Full 1: Partial		ENUM	ALWAYS
Type of clone restore. In Partial Restore Mode the decision, if the parameters are cloned, depends on parameters P1089 to P1091.						
STACK PARAMETERS	1089	0: Load From File	0: Load From File 1: Leave Current 2: Set To Default		ENUM	ALWAYS
Selects if the power parameters should be restored from the SD card.						
MOTOR PARAMETERS	1090	0: Load From File	0: Load From File 1: Leave Current 2: Set To Default		ENUM	ALWAYS
Selects if the power parameters should be restored from the SD card.						
CONFIGURATION	1091	0: Load From File	0: Load From File 1: Leave Current 2: Set To Default		ENUM	ALWAYS
Selects if all other parameters and the DSE Lite configuration file should be restored from the SD card.						
CLONE START	1093	FALSE			BOOL	ALWAYS
Starts a clone save or restore.						

Function Block Outputs

Parameter Name	No.	Default Value	Range	Units	Type	Writable
CLONE STATUS	1094	0: Ready	0: Ready 1: Saving 2: Restoring 3: Verifying 4: Done 5: Done - No App 6: Cannot Start 7: No SD Card 8: Failed Verify 9: File Not Opened 10: File Incompatible 11: Failed File 12: Stack Invalid 13: Failed App 14: Failed Params 15: Failed Memory		ENUM	NOT
Status of the cloning process.						

Functional Description

Notes:

- 1) The clone file only contains the parameters that were stored in non-volatile memory on the drive when a clone save was performed. It is always advisable to perform a parameter save before saving a clone file. When performing a clone load and a full restore is performed or a LOAD FROM FILE is used for the parameters, then any parameter not previously saved in the file will be set to its defaults.
- 2) Each application parameter is restored only if the parameter definition on the target drive matches the saved parameter. For example, if the original file was cloned from a drive with a much older version of firmware than the target drive, some parameters may not transfer correctly
- 3) The clone saving process will take between 3 – 15 seconds depending on the type of SD card used.
- 4) When saving a file with the same filename as an existing file on the SD card, the existing file will be overwritten. To prevent this, use a PC to set the read-only attribute of the file.
- 5) During the clone loading process the MMI screen or LEDs may blink momentarily.
- 6) The default 'Technician' MMI view does not allow access to parameter **1088 Restore Mode**. With default settings a clone operation from Technician view will therefore result in a full clone of Stack, Motor and Application settings.
- 7)

Comms Control

Overview

In Remote Mode, this block sets the **Controlword** of the drive, this mode is set in the Sequencing function block. Refer to the outputs of the Local Control function block for the mode in use.

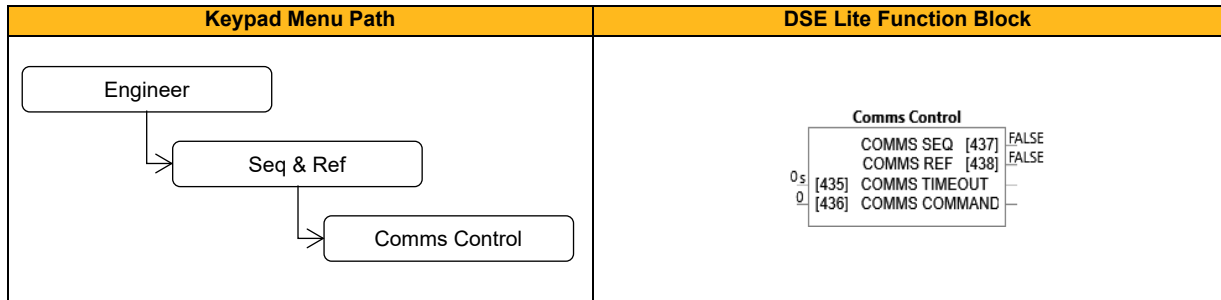

Function Block Inputs

Parameter Name	No.	Default Value	Range	Units	Type	Writable
COMMS TIMEOUT	435	0	0 to 600	s	REAL	ALWAYS
Sets the maximum time allowed between refreshing Comms Command. If the time is exceeded trip 27'command loss' is generated.						
COMMS COMMAND	436	0: 0	0: Switch On 1: Enable Voltage 2: Not Quickstop 3: Enable Operation 4: 5: 6: 7: Reset Fault 8: External Fault 9: 10: Use Comms Control 11: Use Comms Reference 12: Use Jog Reference 13: Reverse Direction 14: 15: Event Triggered Op		Word	Always
Control Word from Fieldbus (bus object 0x21B4). If bit 10 'use comms control' is set, the Comms Command word is used to control the drive. Note: If bit 10 is set, bit 2 'Not Quickstop', bit 1 'Enable Voltage' and bit 0 'Switch On' are ANDed with the application control word 0505 'Remote Command' (influenced by the 'Sequencing' block in DSE Lite). Note: If bit 11 'use comms reference' is set, the 'Comms Setpoint' 0458 (signed, bus object number 0x21CA) is used as the speed reference.						

Function Block Outputs

Parameter Name	No.	Default Value	Range	Units	Type	Writable
COMMS SEQ	437	FALSE			BOOL	NOT
TRUE if in sequencing is taken from the Comms Command.						
COMMS REF	438	FALSE			BOOL	NOT
TRUE if in reference is taken from Comms Reference.						

Control Mode

Overview

The control mode block provides the means for selecting the type of motor and the desired method of controlling the motor.

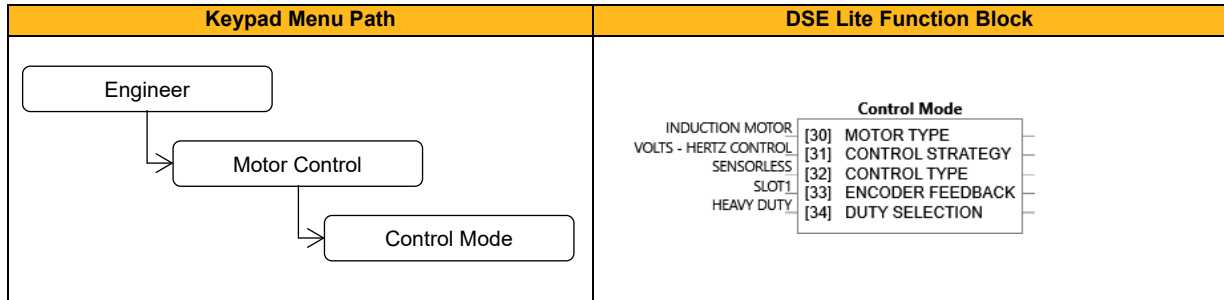

Function Block Inputs

Parameter Name	No.	Default Value	Range	Units	Type	Writable
MOTOR TYPE	30	0: Induction Motor	0: Induction motor 1: PMAC Motor		ENUM	STOPPED
Motor type selection parameter.						
CONTROL STRATEGY	31	0: Volts-Hertz Control	0: Volts-Hertz Control 1: Vector Control		ENUM	STOPPED
Select control strategy selection parameter. Allows the user to select the method of controlling the motor. Note: If PMAC MOTOR is selected as control Motor Type P030 the control strategy is forced to VECTOR CONTROL.						
CONTROL TYPE	32	0: Sensorless	0: Sensorless		ENUM	STOPPED
For INDUCTION MOTOR this parameter is ignored if Control Strategy P031 is set to VOLTS - HERTZ - CONTROL.						
DUTY SELECTION	34	0: Heavy Duty	0: Heavy Duty		ENUM	STOPPED
Heavy Duty provide continuous ratings with higher overload capability (typically 150%, 60s).						

Functional Description

Motor type selection is the first step in setting the control mode.

The selection of control strategy comes next, with the permitted settings as follows:

- Induction motors can be run in either volts hertz mode or vector mode
- Permanent magnet motors can only be run in sensorless vector control mode

Duty selection is fixed at 0: Heavy Duty in the AC15 series

Current Limit

Overview

Designed for all Motor Control Modes

This function allows you to set the maximum level of motor rated current (as a % of the user-set **Motor Current**) which is allowed to flow before current limit action occurs. If the measured motor current exceeds the current limit value with a motoring load, the motor speed is reduced to control the excess load. If the measured motor current exceeds the current limit value with a regenerating load, the motor speed is increased up to a maximum of **Max Speed** (Reference function block).

The maximum value of current limit for a particular motor is limited by the inverter's current rating.

If a motor of larger rating than the inverter is connected, then the current limit max value is limited by the inverter's current rating.

If a motor of lower rating than the inverter is connected, then the current limit max value is limited to 300% (if compatible with the inverter's current rating) for an induction motor (IM) and to the ratio **PMAC Max Current** to **PMAC Rated Current** for a PMAC motor.

Hint: If the current limit is used in Vector Control Mode the minimum setpoint for current limit is limited to 110% of the motor magnetising current (P0175) / rated current (P0222), so that approximately 45% of the mag current setpoint is retained for motor torque control.

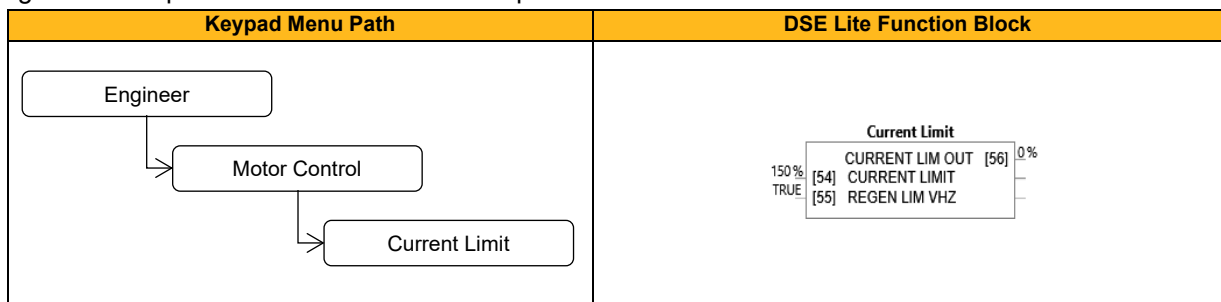

Function Block Inputs

Parameter Name	No.	Default Value	Range	Units	Type	Writable
CURRENT LIMIT	54	150	0 to 600	%	REAL	ALWAYS
This parameter sets the level of motor current, as a % of motor current (refer to the relevant motor definition PMAC or IM function) at which the drive begins to take current limiting action. If the set level of motor current is higher than the available stack (drive) current the internally effective current limit is limited to the stack max current. The effective limit is displayed via P056 'Current Lim Out'). Additionally current at the motor could be further reduced by the torque limit function block.						
REGEN LIM VHZ	55	TRUE			BOOL	ALWAYS
This parameter enables or disables current limit action in 'regenerative motor operation'. 'Regenerative motor operation' occurs when the motor is being overhauled in either forward or reverse direction.						
Note: The regenerative torque (current) limiting function is violated in case of a speed setpoint direction (=sign) change.						
Note: With this flag active and low torque limits, in some cases (e.g., if fixed boost is configured) the drive might not be able to follow the setpoint ramp to zero speed. This includes power off (stop) with (not fast) ramped stop. To ensure the drives stops "smoothly" this parameter should be set false or a higher torque limit could be set. An alternative higher torque limit for stop operation can also be achieved by using a fast (quick) stop, triggered via P0495 'Not Fast Stop' = False. Fast stop has an individual stopping torque limit parameter (P0387 'Fast Stop T_Lim') and a timeout via P0487 'Fast Stop Limit'.						
Note: This parameter is only relevant in open-loop VHz motor control mode.						

Function Block Outputs

Parameter Name	No.	Default Value	Range	Units	Type	Writable
CURRENT LIM OUT	56	0	0 to 600	%	REAL	NOT
Actual current limit including stack (drive) restrictions. This value is used as limiting value in the torque limit function block.						

Functional Description

The output of the current limit block is modified by the Drive's internal protection algorithms. The lesser of the current limit setpoint (P054) and the internally derived current limit will appear at the output of the function block and be used by the motor control function.

Internal limit is a sum of the output of the Stack Inv Time module + reduction as a function of electrical low speed (< 3Hz) and of heatsink temperature. Therefore at low speeds, high temperatures or following a period of overload, current limit may be reduced automatically.

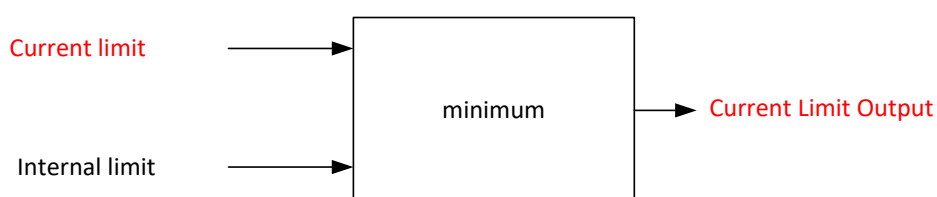

Current Loop

Overview

Current Loop Predictive term

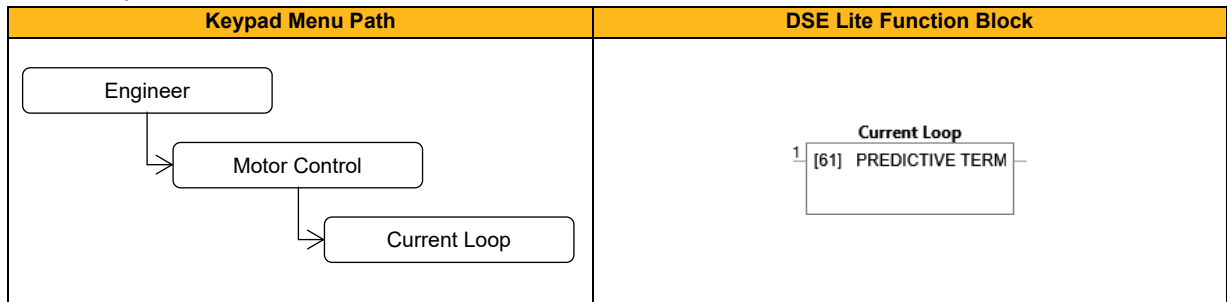

Function Block Inputs

Parameter Name	No.	Default Value	Range	Units	Type	Writable
PREDICTIVE TERM	61	1			BOOL	ALWAYS
Enables the predictive term of the current loop for PMAC motors						

Functional Description

This is to add the predictive term from the current regulator into the voltage demand to increase the dynamic performance of the drive. It is recommended to enable this parameter if a permanent magnet motor is used.

Customise Menus

Overview

Parameters that define the operation of the menus and display/keypad.

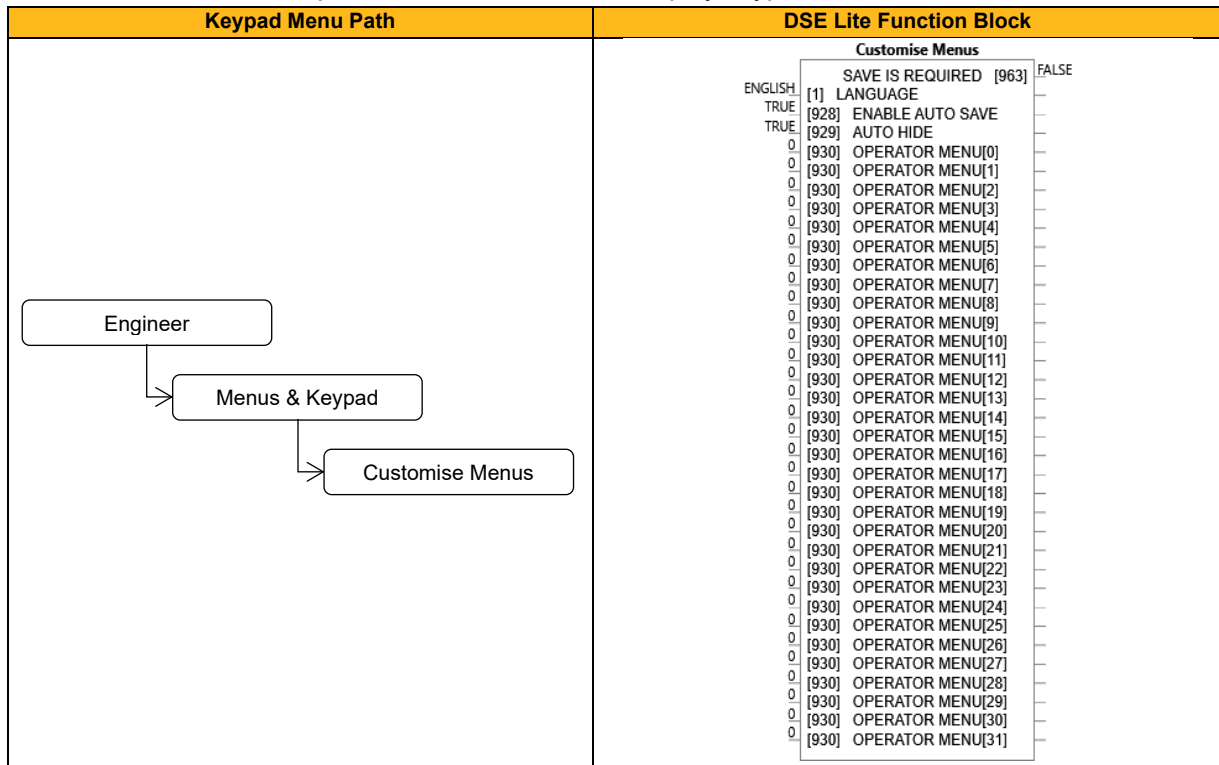

Function Block Inputs

Parameter Name	No.	Default Value	Range	Units	Type	Writable
LANGUAGE	1	0: English	0: English		ENUM	STOPPED
Identifies the currently selected language. Languages other than English are currently not supported.						
ENABLE AUTO SAVE	928	TRUE			BOOL	ALWAYS
When TRUE, parameter changes from the keypad or Web page are automatically saved. When FALSE parameters are not saved until a manual save is selected.						
AUTO HIDE	929	TRUE			BOOL	ALWAYS
Enables auto hiding of parameters that are not relevant to the configuration. For example, parameters for options that are not fitted. Auto hide always applies at OPERATOR and TECHNICIAN view levels.						
OPERATOR MENU[0]	931	0	0 to 4000		PREF	ALWAYS
...	...					
OPERATOR MENU[31]	962					
An array of parameter numbers that defines the contents of the Operator menu. Setting an entry to 0 hides the corresponding entry in the Operator menu.						

Function Block Outputs

Parameter Name	No.	Default Value	Range	Units	Type	Writable
SAVE IS REQUIRED	963	FALSE			BOOL	NOT
Indicates that auto save is off, and a parameter has been changed.						

Functional Description

The mapping blocks expect the TAG number of the required parameter. Links are not accepted, and the TAG number must be entered directly.

An 'operator menu' may be populated with parameters applicable to the application, to simply setup and control. By default, the operator menu has no parameter entries.

For example, if the operator menu is required to display parameter **0102 DC Link Voltage**, **0112 Motor Current** and **0115 Stack Current**, enter the parameter numbers into the operator menu functions as follows:

Operator Menu[0] = 102

Operator Menu[1] = 112

Operator Menu[2] = 114

The parameter numbers of all function block outputs may be found in the individual help file for that block.

DC Link Volts Limit

Overview

This function prevents over-voltage faults occurring due to a rapidly changing setpoint.

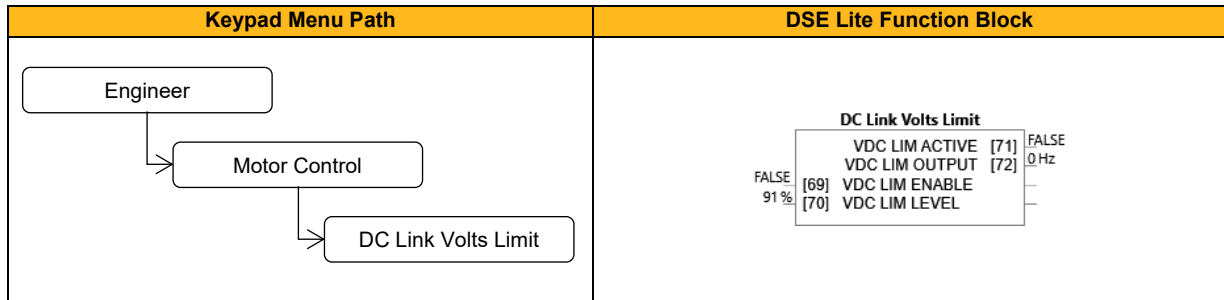

Function Block Inputs

Parameter Name	No.	Default Value	Range	Units	Type	Writable
VDC LIM ENABLE	69	FALSE			BOOL	STOPPED
Enable DC Link Volts Limit during a fast deceleration to prevent overvoltage trip.						
VDC LIM LEVEL	70	91	80 to 100	%	REAL	STOPPED
% of the overvoltage trip level at which DC Link Volts Limit sequence is started.						

Function Block Outputs

Parameter Name	No.	Default Value	Range	Units	Type	Writable
VDC LIM ACTIVE	71	FALSE			BOOL	NOT
Set True when the deceleration ramp is paused in order to limit the DC link voltage.						
VDC LIM OUTPUT	72	0		Hz	REAL	NOT
Output speed setpoint in electrical Hz.						

Functional Description

During a fast deceleration, the kinetic energy of the motor load is regenerated to the drive, charging the DC link capacitors.

When the **VDC Lim Level** is reached, the speed setpoint is held, waiting for the DC link to go below **VDC Lim Level**.

When the DC link falls below this level, the speed setpoint is released and is ramped down using system ramp deceleration.

This sequence is run until the speed setpoint reaches the user speed demand.

By Default, **VDC Lim Level** is set to the same value as the braking threshold.

This feature is run at a rate of 1 milli-second.

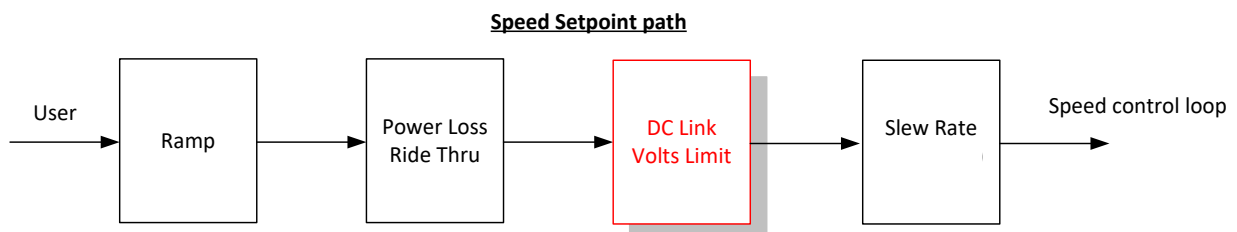

Demultiplexer 1 & Demultiplexer 2

Overview

The demultiplexer function block splits the input word into 16 individual bits. This may be used to extract the individual bits from an integer value for use in sequencing.

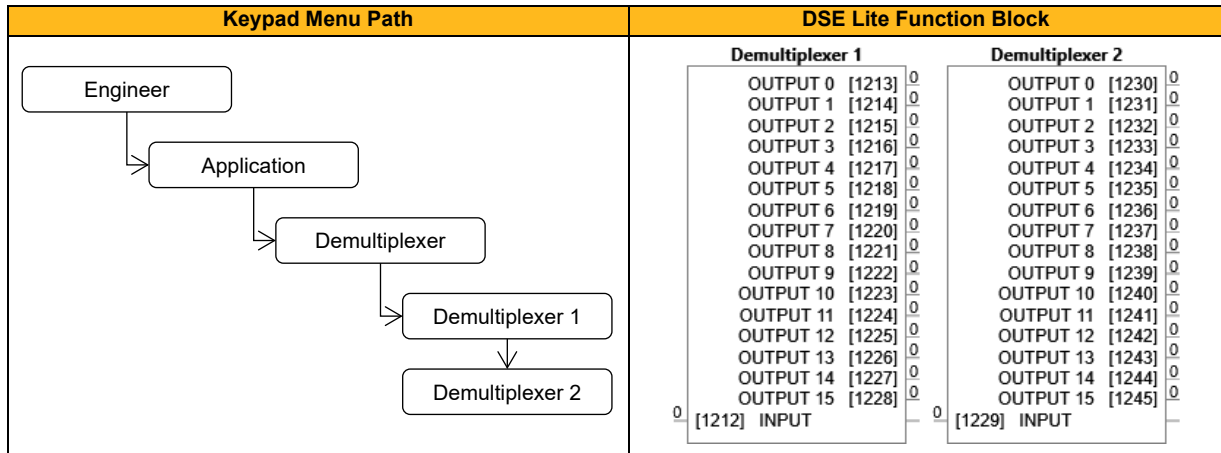

Function Block Inputs

Parameter Name	No.	Default Value	Range	Units	Type	Writable
INPUT						
Demultiplexer 1	1212	0			WORD	ALWAYS
Demultiplexer 2	1229	0			WORD	ALWAYS

Output word (containing Input 1..15). The input to be split into its component bits.

Function Block Outputs

Parameter Name	No.	Default Value	Range	Units	Type	Writable
OUTPUT 0 ... OUTPUT 15						
Demultiplexer 1	1213 ... 1228	0			BIT	NOT
Demultiplexer 2	1230 ... 1245	0			BIT	NOT

Output Bit 0 to Output Bit 15.

Device State

Overview

Operational state of drive.

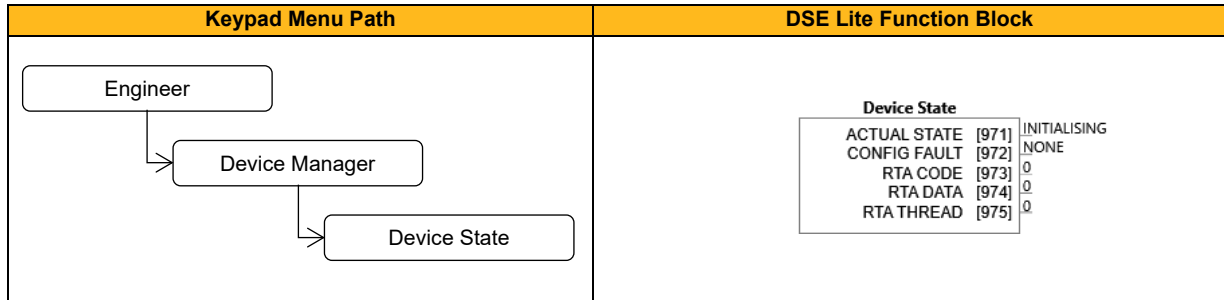

Function Block Outputs

Parameter Name	No.	Default Value	Range	Units	Type	Writable
ACTUAL STATE	971	0: Initialising	0: Initialising 1: Initialised 2: Preparing Preop 3: Preoperational 4: Preparing Op 5: Failed To Ready 6: Ready For Op 7: Operational 8: Faulted 9: Fatal Error Recover		ENUM	NOT
Operating State of the drive, (same as device manager).						
CONFIG FAULT	972	0: None	0: None 1: Application 2: Base Comms 3: Base Io 4: Keypad 5: Motor Control 6: Option Comms 7: Option Io 8: Feedback Missing		ENUM	NOT
Component reporting a Configuration Error						
RTA CODE	973	0			UINT	NOT
RunTime Alert Fault Code						
RTA DATA	974	0			DWORD	NOT
RunTime Alert Fault Data						
RTA THREAD	975	0			SINT	NOT
Priority of thread that was running at the time of the RTA						

Digin 1, Digin 2, Digin 3, Digin 4, Digin 5, Digin 6, Digin 7, Digin 8, Digin 9, Digin 10

Overview

The digital input block converts the physical input voltage to TRUE or FALSE control signals.

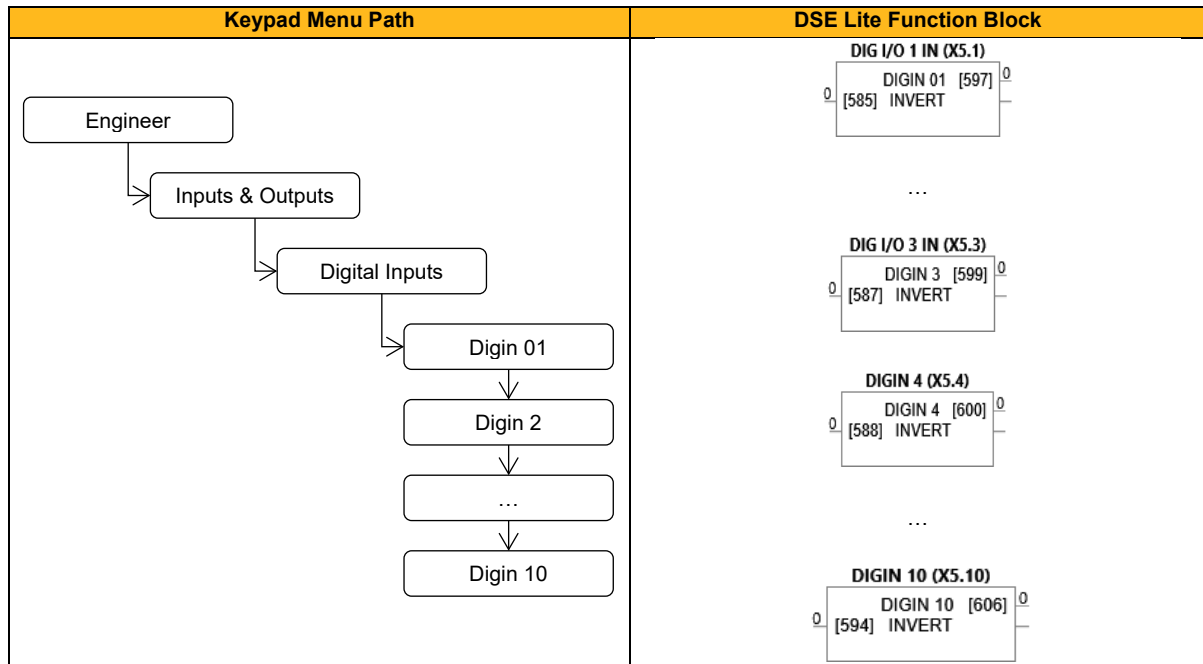

Function Block Inputs

Parameter Name	No.	Default Value	Range	Units	Type	Writable
INVERT						
DIG I/O 1 IN (DX1)	585	0			BIT	ALWAYS
...	...					
DIG I/O 3 IN (DX3)	587	0			BIT	ALWAYS
DIGIN 4 (DI4)	588	0			BIT	ALWAYS
...	...					
DIGIN 10 (DI10)	594	0			BIT	ALWAYS
Invert digital input.						

Function Block Outputs

Parameter Name	No.	Default Value	Range	Units	Type	Writable
DIGIN						
DIG I/O 1 IN (DX1)	597	0			BIT	NOT
...	...					
DIG I/O 3 IN (DX3)	599	0			BIT	NOT
DIGIN 4 (DI4)	600	0			BIT	NOT
...	...					
DIGIN 10 (DI10)	606	0			BIT	NOT
Digital input after inversion.						
Digital input 07 and 08 after inversion. Available for >= Frame 2 only.						
Digital input 09 and 10 after inversion. Available for >= Frame 6 only.						

Functional Description

There is a Digital Input function block associated with each of the following terminals:

The Control Board has 10 configurable digital inputs, three of them as configurable I/O:

Digital Input 1 is associated with terminal DX1 (shares terminal with Digout1)

Digital Input 2 is associated with terminal DX2 (shares terminal with Digout2)

Digital Input 3 is associated with terminal DX3 (shares terminal with Digout3)

Digital Input 4 is associated with terminal DI4, Digital Input 5 is associated with terminal DI5 etc.

The input electronics of the Inverter converts the input signal to a TRUE or FALSE logic value. The digital input block takes this value and optionally inverts it before providing the **Digin x** output.

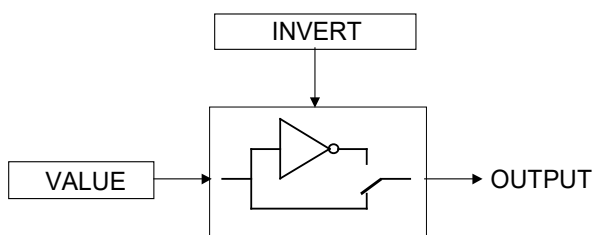

Digital Inputs

Overview

The Digital Inputs block signals the actual state of the Digital Inputs and the STO signals.

Setting the input **0583 Digin Pull Up** = TRUE pulls the unconnected inputs of Digin 4 through Digin 10 high (PNP). This parameter has no influence on the combined DIO's Digin 1,2,3 or Digin 11 and 12.

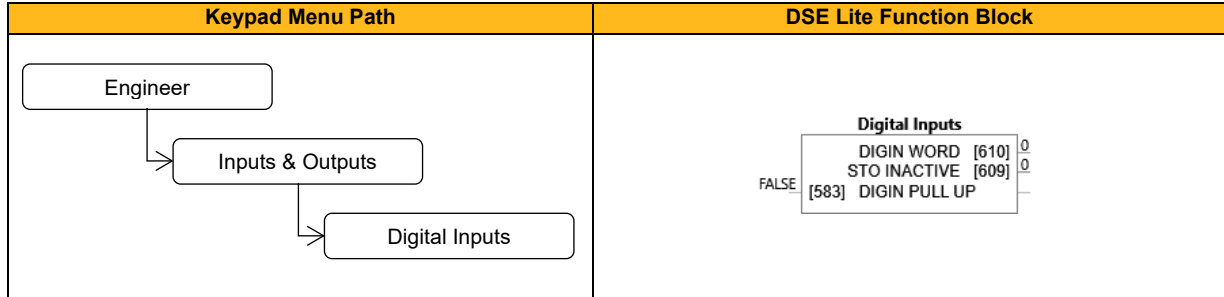

Function Block Inputs

Parameter Name	No.	Default Value	Range	Units	Type	Writable
DIGIN PULL UP	583	FALSE			BOOL	ALWAYS
TRUE: Unconnected inputs are pulled High.						
FALSE: Unconnected inputs are pulled to Low. Note: This parameter only applies to dedicated inputs (DI4...DI10) but not to combined digital in/outputs (DX1...DX3, DX11...DX12).						

Function Block Outputs

Parameter Name	No.	Default Value	Range	Units	Type	Writable
DIGIN WORD	610	0: 0	Bit 0: Digin 01 Bit 1: Digin 02 Bit 2: Digin 03 Bit 3: Digin 04 Bit 4: Digin 05 Bit 5: Digin 06 Bit 6: Digin 07 Bit 7: Digin 08 Bit 8: Digin 09 Bit 9: Digin 10 Bit 10: Digin 11 Bit 11: Digin 12 Bit 12: ... Bit 13: ... Bit 14: ... Bit 15: STO Inactive		WORD	NOT
Digital inputs after inversion, combined into a bitfield. STO inactive is on bit 16 (starting count with 1).						
STO INACTIVE	609	0			BIT	NOT
Indicates that the drive will start if the RUN command is activated.						

Digout 1, Digout 2 & Digout 3

Overview

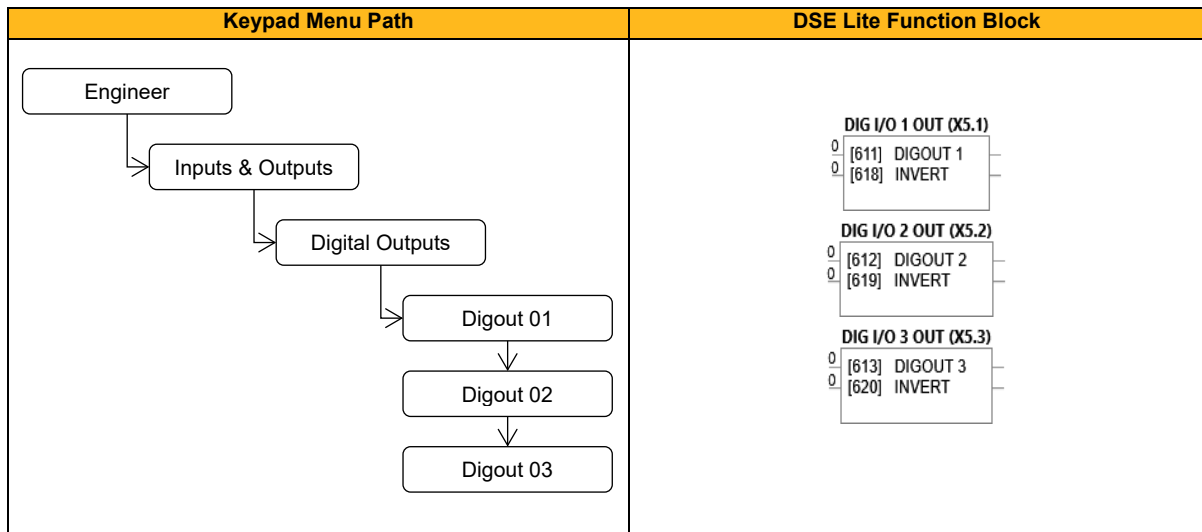

The digital output block converts a logic TRUE or FALSE demand to a physical output signal.

Function Block Inputs

Parameter Name	No.	Default Value	Range	Units	Type	Writable
DIGOUT						
DIG I/O 1 OUT (DX1)	611	0			BIT	ALWAYS
DIG I/O 2 OUT (DX2)	612	0			BIT	ALWAYS
DIG I/O 3 OUT (DX3)	613	0			BIT	ALWAYS
Digital output before inversion.						
INVERT						
DIG I/O 1 OUT (DX1)	618	0			BIT	ALWAYS
DIG I/O 2 OUT (DX2)	619	0			BIT	ALWAYS
DIG I/O 3 OUT (DX3)	620	0			BIT	ALWAYS
Invert digital output.						

Functional Description

There is a DIGITAL OUTPUT function block associated with each of the following terminals. The Control Board has three digital outputs (volt-free relay contacts):

Digital Output 1 is associated with terminal DX1, shares terminal with Digital Input 1.

Digital Output 2 is associated with terminal DX2, shares terminal with Digital Input 2.

Digital Output 3 is associated with terminal DX3, shares terminal with Digital Input 3.

Setting either **Digout** or **Invert** to TRUE will individually configure the block to be an output. Note that because **Invert** reverses the output logic, setting both **Digout** and **Invert** to TRUE will configure the block to be an input.

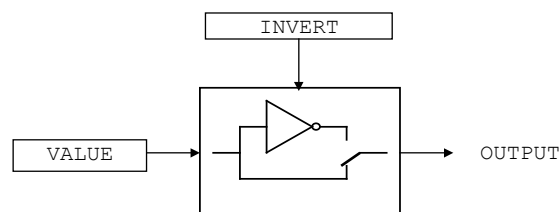

Drive Info

Overview

Drive name and serial numbers.

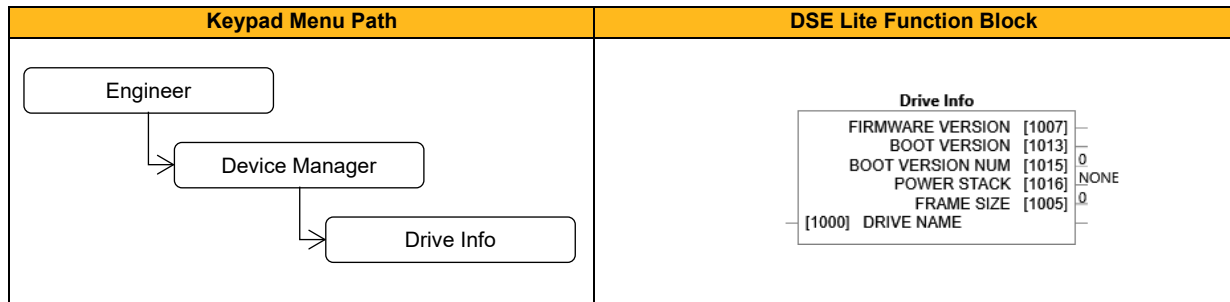

Function Block Inputs

Parameter Name	No.	Default Value	Range	Units	Type	Writable
DRIVE NAME	1000				STRING	ALWAYS
A string value that may be used to identify this drive in a system.						
NOMINAL SUPPLY	1006	0: 50 Hz 400V	0: 50 Hz 400V 1: 60 Hz 480V 2: 50 Hz 230V 3: 60 Hz 230V		ENUM	STOPPED
This parameter is only available via Keypad or in web interface. Used to select the default values corresponding to the base frequency (motor volts and nameplate rpm) for a new configuration. Attention: Changing this parameter resets the dependent parameters P0226 'Nameplate Speed', P0224 'Base Frequency', P0223 'Base Voltage' and P0457 'Max Speed' to their default values! This value is reset to default if the StackID is changed.						

Function Block Outputs

Parameter Name	No.	Default Value	Range	Units	Type	Writable
FIRMWARE VERSION	1007				STRING	NOT
The version of the firmware running in the Control Module.						
BOOT VERSION	1013				STRING	NOT
The version of the Boot Loader running in the Control Module						
BOOT VERSION NUM	1015	0			WORD	NOT
The Version of the Boot Loader as a hex value.						
POWER STACK	1016	0: None	0: None 1: 2.5 A 230 V Ph1 2: 4.5 A 230 V Ph1 3: 7.0 A 230 V Ph1 4: 7.0 A 230 V Ph1 5: 10 A 230 V Ph1 6: 2.5 A 230 V 7: 4.5 A 230 V 8: 7.0 A 230 V 9: 7.0 A 230 V 10: 10 A 230 V 11: 17 A 230 V 12: 21 A 230 V 13: 30 A 230 V 14: 40 A 230 V 15: 1.0 A 400 V 16: 2.0 A 400 V 17: 4.0 A 400 V 18: 4.0 A 400 V 19: 6.5 A 400 V 20: 9.0 A 400 V 21: 12 A 400 V 22: 17 A 400 V		ENUM	NOT

			23: 23 A 400 V 24: 32 A 400 V 25: 38 A 400 V 26: 44 A 400 V 27: 60 A 400 V 28: 75 A 400 V 29: 90 A 400 V 30: 110 A 400 V 31: 150 A 400 V 32: 180 A 400 V 33: 220 A 400 V 34: 265 A 400 V 35: 320 A 400 V 36: 360 A 400 V			
Enumerated value showing the power stack rating. This set indirectly by Stack ID in Product Data.						
FRAME SIZE	1005	0	0 to 10		USINT	NOT
Frame size of this drive						

Encoder

Overview

This feature allows you to setup and monitor the operation of the Encoder. The AC15 encoder block does not provide closed loop vector control, however the output of the block may be used in conjunction with a PID function block to perform simple closed loop speed control.

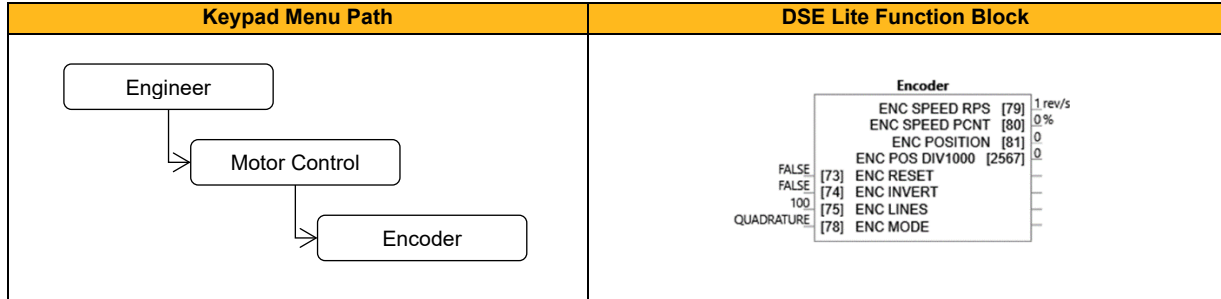

Function Block Inputs

Parameter Name	No.	Default Value	Range	Units	Type	Writable
ENC RESET						
ENCODER	73	FALSE			BOOL	ALWAYS
When TRUE the POSITION output is set (and held) at zero (no influence on encoder speed signals).						
ENC INVERT						
ENCODER	74	FALSE			BOOL	STOPPED
When TRUE, changes the sign of the measured speed and the direction of the position count.						
ENC LINES						
ENCODER	75	100	1 to 65535		UINT	STOPPED
The number of lines of the encoder.						
ENC MODE						
ENCODER	78	0: Quadrature	0: Quadrature 1: Clock & Dir 2: Clock		ENUM	STOPPED
Quadrature or clock/direction encoder.						

Function Block Outputs

Parameter Name	No.	Default Value	Range	Units	Type	Writable
ENC SPEED RPS						
ENCODER	79	1	1 to	rev/s	REAL	NOT
The encoder speed in mechanical revolutions per second.						
ENC SPEED PCNT						
ENCODER	80	0		%	REAL	NOT
Speed feedback as a percentage of Max Speed						
ENC POSITION						
ENCODER	81	0	-2147483648...2147483648		DINT	NOT
Number of encoder "counts" from when RESET was set to FALSE. Starts from zero, range $-2^{31} \dots + (2^{31}) - 1$, overflow at max range value. Real format (divided by 1000) counts value on P2567 'Enc Pos div1000'.						
ENC POS DIV1000						
ENCODER	2567	0	-2147483.5 to +2147483.5		REAL	NOT
Number of encoder "counts" on P0081 divided by 1000. This signal can be used to provide encoder counts to value function blocks. Starts from zero, range in real (single precision float) is $-2147483.5 \dots 2147483.5$. Value starts to lose precision if magnitude value is ≥ 16384.000 ($=16384000$ incr), quantization at max value is 250incr.						

Functional Description

A quadrature encoder uses 2 input signals (A and B), phase shifted by a quarter of a cycle (90°). Direction is obtained by looking at the combined state of A and B.

Speed is calculated using the following function:

$$\text{SPEED HZ} = \text{filter} \left[\frac{\text{CountsPerSecond}}{\text{Lines} \times 4}, \text{FilterTime} \right]$$

Where counts per second are the number of edges received from the encoder. There are 4 counts per line.

Energy Meter

Overview

This block measures the electrical energy used by the load.

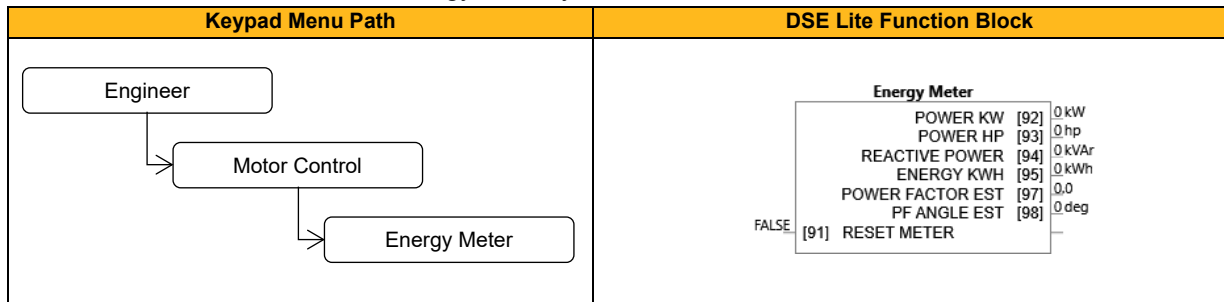

Function Block Inputs

Parameter Name	No.	Default Value	Range	Units	Type	Writable
RESET METER	91	FALSE			BOOL	ALWAYS
When Reset Energy Meter is set to TRUE, the Energy kWh parameter is reset.						

Function Block Outputs

Parameter Name	No.	Default Value	Range	Units	Type	Writable
POWER KW	92	0	0 to 1000000	kW	REAL	NOT
This diagnostic shows the power being delivered to the load in kilowatts.						
POWER HP	93	0	0 to 1000000	hp	REAL	NOT
This diagnostic shows the power being delivered to the load in horsepower.						
REACTIVE POWER	94	0	0 to 1000000	kVA _r	REAL	NOT
This diagnostic shows the reactive power being delivered to the load in kilo volt-amperes reactive.						
ENERGY KWH	95	0	0 to 10000000	kWh	REAL	NOT
This diagnostic shows the total energy consumed by the load in kilowatt hours.						
POWER FACTOR EST	97	0.0	0.0 to 1.0		REAL	NOT
This diagnostic shows the power factor estimate (between 0 and 1).						
PF ANGLE EST	98	0	0 to 90	deg	REAL	NOT
This diagnostic shows the power factor angle estimate.						

Ethernet Setup

Overview

Base Ethernet communications settings.

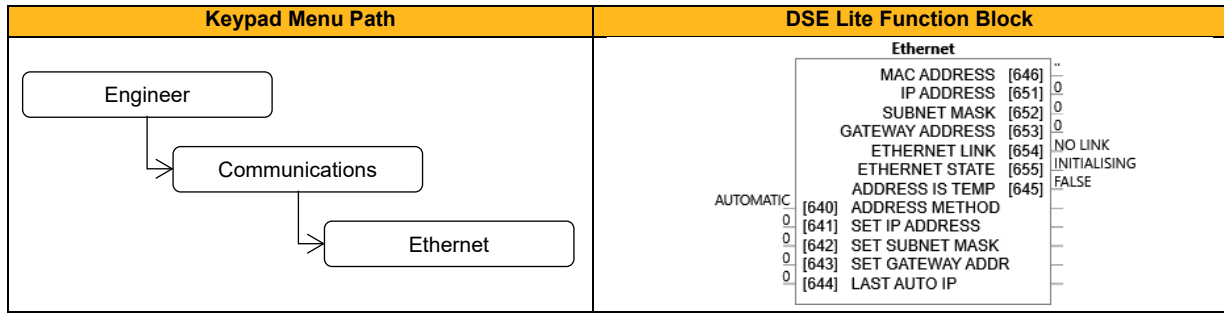

Function Block Inputs

Parameter Name	No.	Default Value	Range	Units	Type	Writable
ADDRESS METHOD	640	3: Automatic	0: Fixed 1: n.a. 2: Link Local 3: Automatic		ENUM	ALWAYS
<p>Method for obtaining the IP address.</p> <p>By setting a Fixed Address, the IP address must be set manually. The IP address, subnet mask and gateway address will be set from the values in the parameters 0641 Set IP Address, 0642 Set Subnet Mask, 0643 Set Gateway Address.</p> <p>Using Link Local Address Method, the inverter may assign itself a link-local address automatically. This would be used where an automatic address is required but where no DHCP server is available, such as a small local network or when connecting an inverter directly to a PC (point to point).</p> <p>For Automatic Address Method, the DHCP is activated automatically. The IP address is then assigned by the DHCP server. The inverter will request an IP address, subnet mask and gateway address from the DHCP server.</p>						
SET IP ADDRESS	641	0			ADDR	ALWAYS
The required IP address for the base Ethernet. This requires the parameter Address Method to be set to FIXED.						
SET SUBNET MASK	642	0			ADDR	ALWAYS
The required subnet mask for the base Ethernet. This requires the parameter Address Method to be set to FIXED.						
SET GATEWAY ADDR	643	0			ADDR	ALWAYS
The required gateway address for the base Ethernet. This requires the parameter Address Method to be set to FIXED.						
LAST AUTO IP	644	0			ADDR	ALWAYS
Indicates the last Auto-IP address used by the base Ethernet.						

Function Block Outputs

Parameter Name	No.	Default Value	Range	Units	Type	Writable
MAC ADDRESS	646	"			STRING	NOT
Indicates the MAC address of the base Ethernet.						
IP ADDRESS	651	0			ADDR	NOT
Indicates the base Ethernet IP address in use.						
SUBNET MASK	652	0			ADDR	NOT
Indicates the base Ethernet subnet mask in use.						
GATEWAY ADDRESS	653	0			ADDR	NOT
Indicates the base Ethernet gateway address in use.						
ETHERNET LINK	654	0: No Link	0: No Link 1: 10m Half Duplex 2: 10m Full Duplex 3: 100m Half Duplex 4: 100m Full Duplex		ENUM	NOT
Status of the physical Ethernet link.						
ETHERNET STATE	655	0: Initialising	0: Initialising 1: No Link 2: Resolving IP 3: Resolved Fixed 4: Resolved DHCP 5: Resolved Auto IP 6: Fault		ENUM	NOT
Indicates the state of the base Ethernet.						
ADDRESS IS TEMP	645	FALSE			BOOL	NOT
Externally set IP address is temporary.						

Fan Control

Overview

Fan control configuration and status.

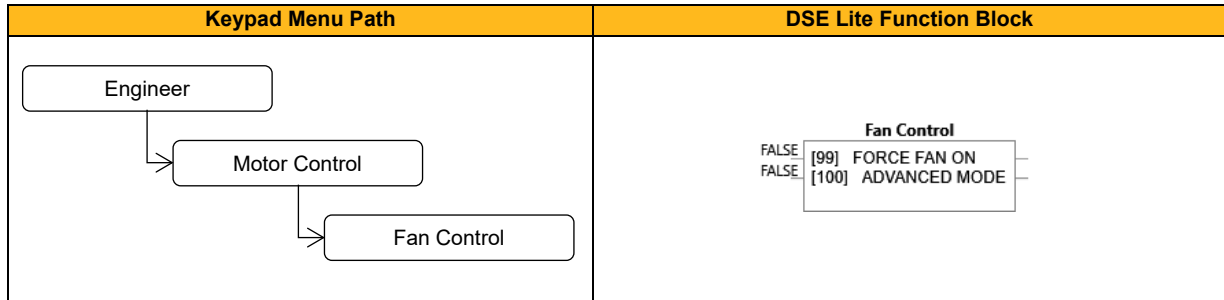

Function Block Inputs

Parameter Name	No.	Default Value	Range	Units	Type	Writable
FORCE FAN ON	99	FALSE			BOOL	ALWAYS
When TRUE the fan will be on.						
ADVANCED MODE	100	FALSE			BOOL	ALWAYS
When FALSE the fan will be activated when the drive is running. When TRUE the fan will be activated if the motor is running at over 20% of stack rated current or the heatsink is hot.						

Functional Description

The purpose of this parameter is to turn the fan on when it would otherwise not be running. This may be useful to stir air in an enclosure if the drive has been idle for an extended period of time. Stirring air can help to reduce condensation in an enclosure.

The fan will always turn on independently of “Force Fan On” if the drive heatsink is hot or if the drive is running. In this case the fan will continue to run for one minute after the drive has stopped and the heatsink is cool. This mode of operation over-rides the “Force Fan On” parameter.

Feedbacks

Overview

The Feedbacks block allows you to view speed feedback and motor current related diagnostics.

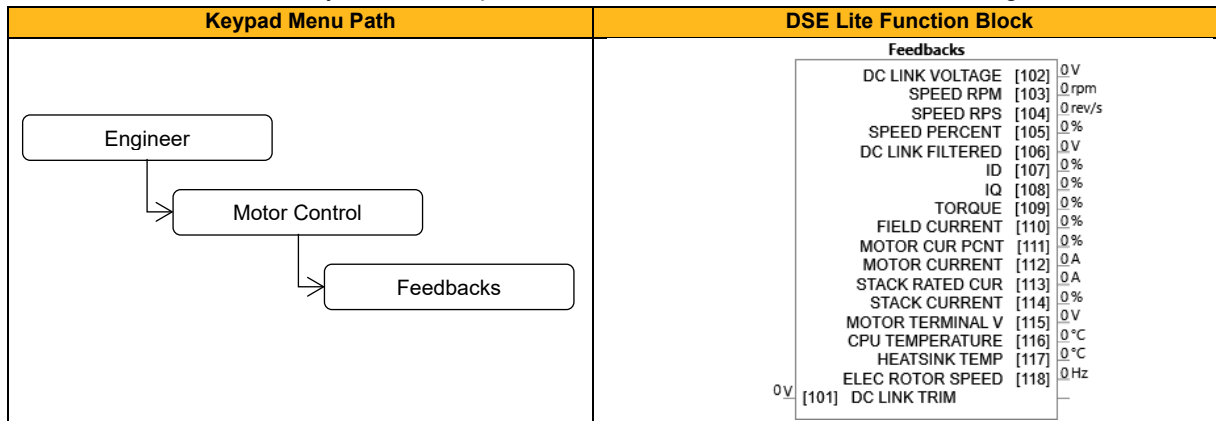

Function Block Inputs

Parameter Name	No.	Default Value	Range	Units	Type	Writable
DC LINK TRIM	101	0	-20 to 20	V	REAL	ALWAYS
Offset applied internally to the DC Link volts measurement. May be used to equalize all drives on a shared supply.						

Function Block Outputs

Parameter Name	No.	Default Value	Range	Units	Type	Writable
DC LINK VOLTAGE	102	0	0 to 1000	V	REAL	NOT
This shows the voltage across the dc link capacitors.						
SPEED RPM	103	0	-100000 to 100000	rpm	REAL	NOT
Details see P0104 'Speed rps'.						
SPEED RPS	104	0	-1500 to 1500	rev/s	REAL	NOT
This parameter changes according to the Control Mode: <ul style="list-style-type: none"> In sensorless Vector mode the parameter shows the calculated mechanical speed (Induction; 5ms average, PMAC: 0.1s filter time constant) of the motor shaft in revolutions per second. In Volts/Hz mode, the parameter shows the (setpoint) motor synchronous speed in revolutions per second. P0103 'Speed rpm' is this parameter multiplied with 60rpm/rps 						
SPEED PERCENT	105	0	-200 to 200	%	REAL	NOT
This parameter changes according to the Control Mode: <ul style="list-style-type: none"> In Sensorless Vector mode the parameter shows the calculated mechanical speed of the motor shaft as a percentage of the user maximum speed setting (Max Speed in the Reference function). In Volts/Hz mode, the parameter shows the electrical drive output frequency as a percentage of the user maximum speed setting (Max Speed in the Reference function). 						
DC LINK FILTERED	106	0	0 to 1000	V	REAL	NOT
DC link filtered value (100ms time constant)						
ID	107	0	-600 to 600	%	REAL	NOT
Current in the flux axis, 1ms average value.						
IQ	108	0	-600 to 600	%	REAL	NOT
Current in the torque axis (Vector Control), 1ms average value.						
TORQUE	109	0	-600 to 600	%	REAL	NOT
Calculated torque, based on the Iq current.						
FIELD CURRENT	110	0	-200 to 200	%	REAL	NOT
Calculated field, based on the Id current.						
MOTOR CUR PCNT	111	0	0 to 600	%	REAL	NOT
This diagnostic shows the level of rms line current being drawn from the drive as a percentage of the rated current of the relevant motor definition, 2s time constant filter applied.						
MOTOR CURRENT	112	0	0 to 2000	A	REAL	NOT
This diagnostic shows the level of rms line current in Amps being drawn from the drive, 0,5s time constant filter applied.						
STACK RATED CUR	113	0	0 to 2000	A	REAL	NOT
This diagnostic indicates the stack rating in Amps. This reduces as a function of pwm switching frequency.						
STACK CURRENT	114	0	0 to 500	%	REAL	NOT
Stack current as a percentage of stack rated current, based on 1ms id and iq, 5ms update rate.						
MOTOR TERMINAL V	115	0	0 to 1000	V	REAL	NOT
Volts between motor phases in Vrms.						
CPU TEMPERATURE	116	0	-25 to 200	°C	REAL	NOT
Ambient temperature of Control Module.						
HEATSINK TEMP	117	0	-25 to 200	°C	REAL	NOT
This diagnostic displays the power stack heatsink temperature in degree centigrade.						
ELEC ROTOR SPEED	118	0	-1500 to 1500	Hz	REAL	NOT
Electrical rotor speed in electrical Hz. For non V/Hz operation modes this is P0104 'speed rps' multiplied with motor pole pairs, in V/Hz mode it is the demand electrical frequency value.						

Fieldbus Config

Overview

Built-in fieldbus communications.

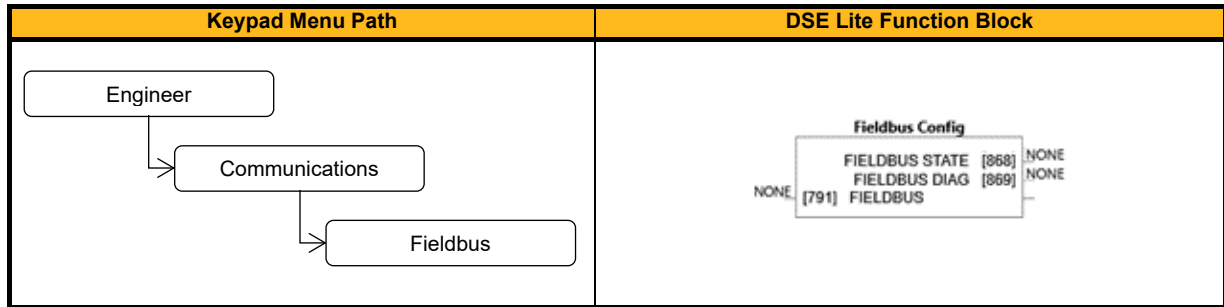

Function Block Inputs

Parameter Name	No.	Default Value	Range	Units	Type	Writable
FIELDBUS	791	0: None	0: None 1: Ethernet IP		ENUM	CONFIG
Selects the required Built-in fieldbus protocol.						
DO NOT CLEAR IP	858	FALSE			BOOL	CONFIG

Function Block Outputs

Parameter Name	No.	Default Value	Range	Units	Type	Writable
FIELDBUS STATE	868	0: None	0: None 1: Setup 2: Initialising 3: Waiting To Connect 4: Stop Mode 5: Connected 6: Error		ENUM	NOT
Current state of the fieldbus.						
FIELDBUS DIAG	869	0: None	0: None 1: Not Supported 2: Input Mapping Failed 3: Output Mapping Failed 4: Mapping Mismatch 5: Parameter Range		ENUM	NOT
Diagnostic indicating if there is a configuration error.						

Fieldbus Output Mapping

Overview

Built-in fieldbus communications.

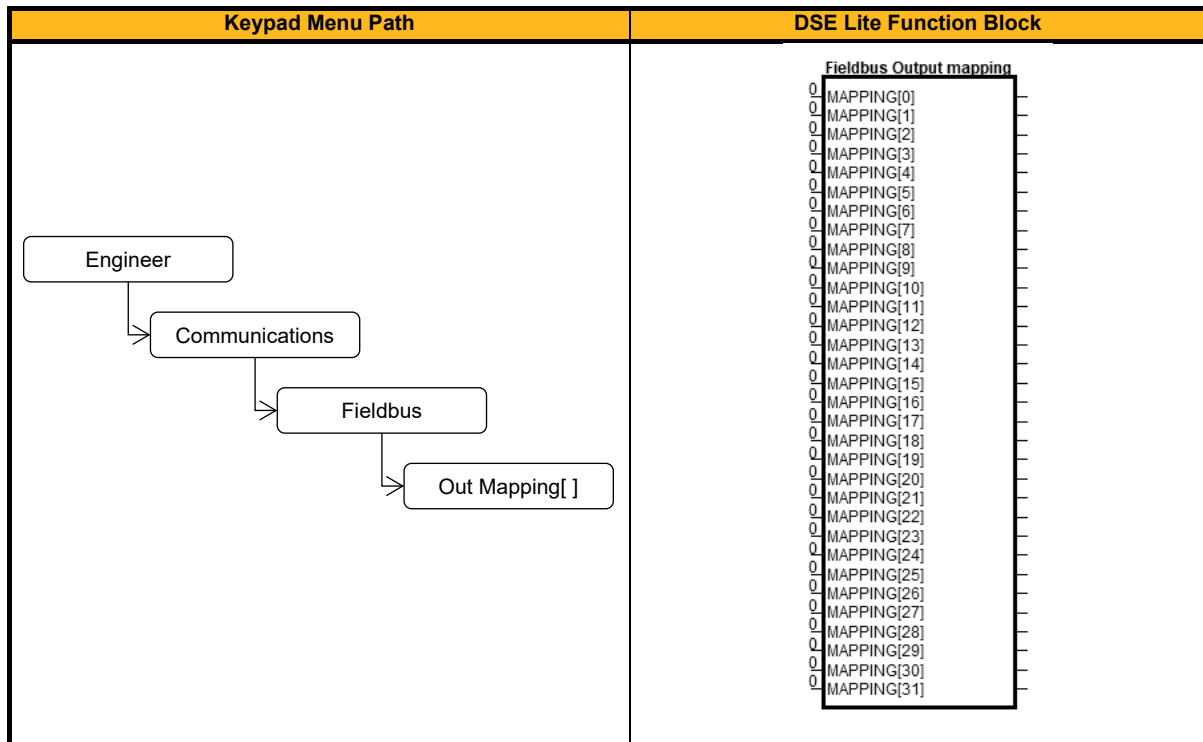

Function Block Inputs

Parameter Name	No.	Default Value	Range	Units	Type	Writable
MAPPING[0] ... MAPPING[31]	826 ... 857	0			PREF	CONFIG
Defines the cyclic (TxPDO) data output mapping table (32 entries). The value entered is the Tag ID of the parameter to be cyclically transferred. First 0 entry in parameter range 0826...0857 indicates end of the table. If the mapping is defined (written) by the PLC the first mapping entry in parameter 0826 must be 0. This can be ensured by setting parameter 2565 PN MasterMapping = TRUE. If the mapping is defined (written) by the PLC, that mapping will not appear in these parameters – they will remain as zeros.						

Functional Description

The mapping blocks expect the TAG number of the required parameter. Links are not accepted, and the TAG number must be entered directly. Below a list of commonly used parameters as an example.

Parameter Name	No.	Type	Bytes	PLC R/W
Device State	0971	USINT	1	Write (Mapping Output)
Statusword	0507	WORD	2	Write (Mapping Output)
Reference	0462	REAL	4	Write (Mapping Output)
Speed rpm	0103	REAL	4	Write (Mapping Output)
Anin1 Value	0534	REAL	4	Write (Mapping Output)
Anin2 Value	0540	REAL	4	Write (Mapping Output)
Anout1 Value	0558	REAL	4	Write (Mapping Output)
Anout2 Value	0563	REAL	4	Write (Mapping Output)
Digin Word	0610	WORD	2	Write (Mapping Output)
Digout Word	0625	WORD	2	Write (Mapping Output)
Speed Demand	0460	REAL	4	Write (Mapping Output)
Speed Percent	0105	REAL	4	Write (Mapping Output)
Active Trip Hi	876	DWORD	4	Write (Mapping Output)
Active Trip Lo	877	DWORD	4	Write (Mapping Output)
Motor current (%)	111	REAL	4	Write (Mapping Output)

Fieldbus Input Mapping

Overview

Built-in fieldbus communications.

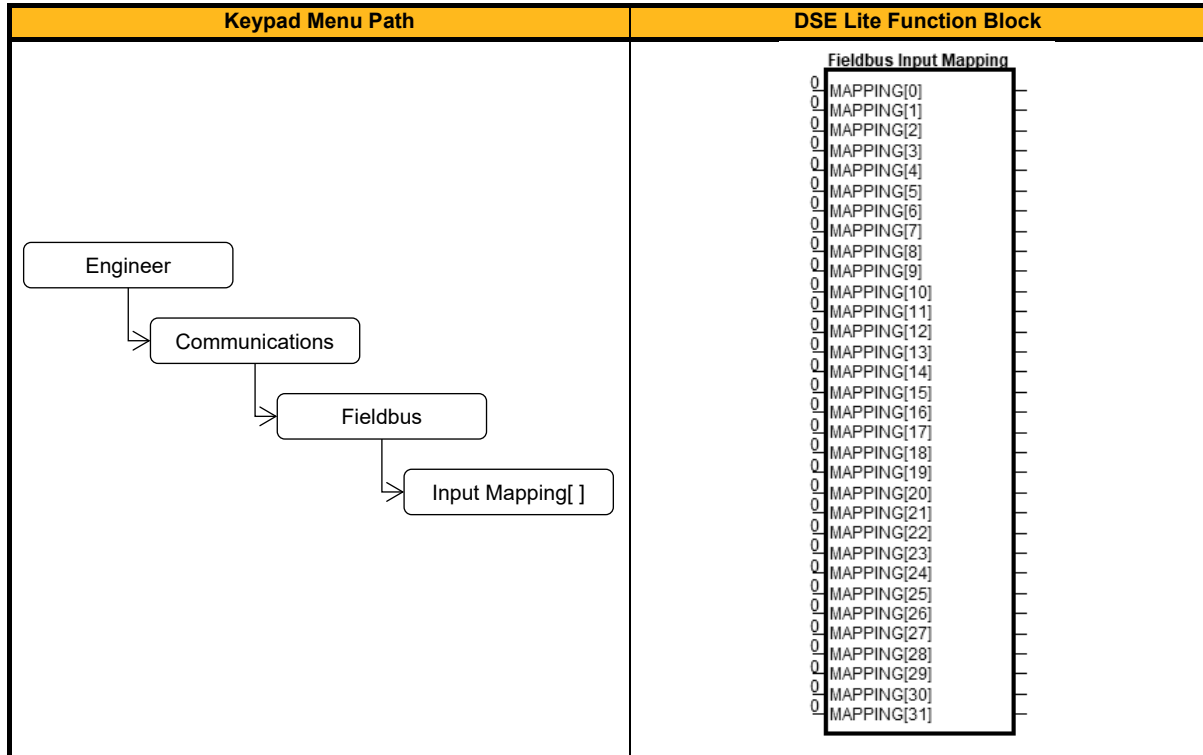

Function Block Inputs

Parameter Name	No.	Default Value	Range	Units	Type	Writable
MAPPING[0]	793	0			PREF	CONFIG
...	...					
MAPPING[31]	824					

Defines the cyclic (RxPDO) data input mapping table (32 entries). The value entered is the Tag ID of the parameter to be cyclically transferred. First 0 entry in parameter range 0793...0824 indicates the end of the table.
 If the mapping is defined (written) by the PLC the first mapping entry on parameter 0793 must be 0. This can be ensured by setting parameter **2565 PN MasterMapping** = TRUE. If the mapping is defined (written) by the PLC, that mapping will not appear in these parameters – they will remain as zeros.

Functional Description

The mapping blocks expect the TAG number of the required parameter. Links are not accepted, and the TAG number must be entered directly. Below a list of commonly used parameters as an example.

Parameter Name	No.	Type	Bytes	PLC R/W
Comms Command (Controlword)	0436	WORD	2	Read (Mapping Input)
Remote Setpoint	0451	REAL	4	Read (Mapping Input)
Remote Reverse	0497	BOOL	1	Read (Mapping Input)
Rem Trip Reset	0498	BOOL	1	Read (Mapping Input)
Value Func 1.Input B	2071	REAL	4	Read (Mapping Input)
Demultiplexer1.Input	1212	WORD	2	Read (Mapping Input)
Digin Invert	0584	WORD	2	Read (Mapping Input)
Digout Invert	0626	WORD	2	Read (Mapping Input)
Fan Running	0520	BOOL	1	Read (Mapping Input)
Minimum Speed	1797	REAL	4	Read (Mapping Input)

Fire Mode

Overview

Emergency services mode.

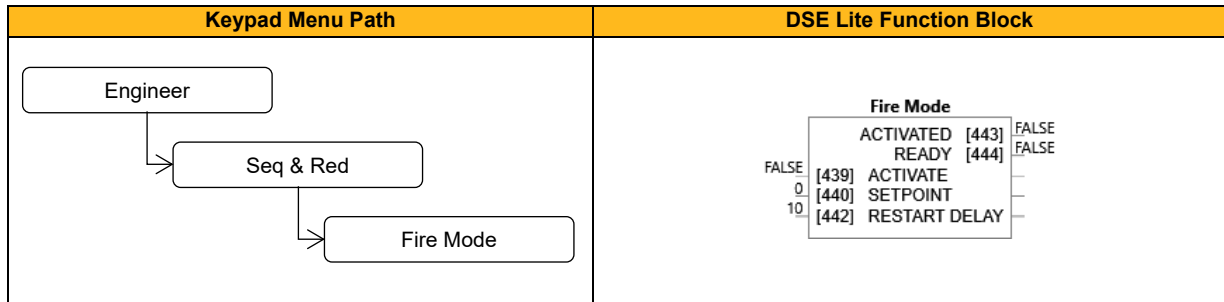

Function Block Inputs

Parameter Name	No.	Default Value	Range	Units	Type	Writable
ACTIVATE	439	FALSE			BOOL	ALWAYS
Enable Fire Mode according to the Fire Mode parameter. It can be only set by a connection in the application.						
SETPOINT	440	0	-100 to 100		REAL	ALWAYS
Reference value to be used when Fire Mode is active. Setting a negative setpoint will cause the drive to rotate in reverse direction.						
RESTART DELAY	442	10	0.1 to 60.0		TIME	ALWAYS
Specifies the time to wait before attempting to reset a trip.						

Function Block Outputs

Parameter Name	No.	Default Value	Range	Units	Type	Writable
ACTIVATED	443	FALSE			BOOL	NOT
Indicates when Fire Mode is active. This is TRUE when the FireMode Setpoint is not 0.0% and Activate is TRUE.						
READY	444	FALSE			BOOL	NOT
This is TRUE when the FireMode Setpoint is not 0.0% (it indicates if Fire Mode will be activated after 0439 FireMode Activate is set TRUE).						

Functional Description

Refer to chapter 13 Fire Mode

Fluxing V/Hz

Overview

Designed for V/Hz motor Control Mode, this function allows user parameterization of the conventional (Volts/Hertz) fluxing strategy of the drive. This is achieved through three flexible Volts-to-frequency templates. Starting torque performance can also be tailored through the **0127 Fixed Boost**, **0130 Accel Boost** and **0128 Auto Boost** parameters.

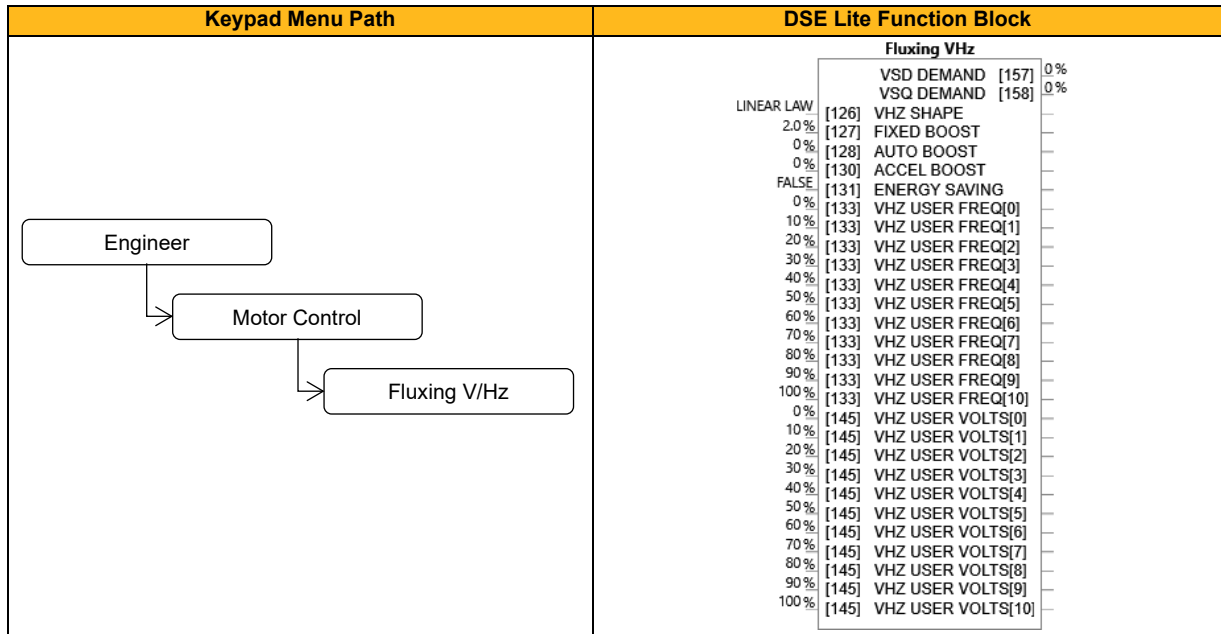

Function Block Inputs

Parameter Name	No.	Default Value	Range	Units	Type	Writable
VHZ SHAPE	126	0: Linear Law	0: Linear Law 1: Fan Law 2: User Defined		ENUM	STOPPED
Type of volts to frequency template to flux the motor.						
FIXED BOOST	127	2	0 to 25	%	REAL	ALWAYS
This parameter allows for no-load stator resistance voltage drop compensation. This correctly fluxes the motor (under no-load conditions) at low output frequencies (=stable motor operation / velocity), thereby increasing available motor torque. Fixed boost can be set in addition to auto boost and acceleration boost. Note: While in VHz control mode torque limiting might lead to unexpected behaviour if fixed boost is used (not 0%). For details see P0055 'Regen. Limit VHz' description. Unit is in % of available or rated motor voltage.						
AUTO BOOST	128	0	0 to 25	%	REAL	ALWAYS
This parameter allows for load dependent stator resistance voltage drop compensation. This correctly fluxes the motor (under load conditions) at low output frequencies, thereby increasing available motor torque. Auto Boost can be set in addition to Fixed Boost. The Auto Boost parameter determines the level of additional volts supplied to the motor for 100% load. Setting the value of auto boost too high can cause the Drive to enter current limit. If this occurs, the Drive will be unable to ramp up in speed. Unit is in % of available or rated motor voltage.						
ACCEL BOOST	130	0	0 to 25	%	REAL	ALWAYS
Additional amount of fixed boost when the drive is accelerating. A value > 0% is needed to accelerate the motor in case of high load torque (or friction) or high load inertia. Unit is in % of available or rated motor voltage.						
ENERGY SAVING	131	FALSE			BOOL	ALWAYS
Enable energy saving mode to minimize energy consumption.						
VHZ USER FREQ[0]	134	0	0 to 100	%	REAL	STOPPED
Array of user defined frequency for V/f control.						
VHZ USER FREQ[1]	135	10	0 to 100	%	REAL	STOPPED
Array of user defined frequency for V/f control.						
VHZ USER FREQ[2]	136	20	0 to 100	%	REAL	STOPPED
Array of user defined frequency for V/f control.						
VHZ USER FREQ[3]	137	30	0 to 100	%	REAL	STOPPED
Array of user defined frequency for V/f control.						

VHZ USER FREQ[4]	138	40	0 to 100	%	REAL	STOPPED
Array of user defined frequency for V/f control.						
VHZ USER FREQ[5]	139	50	0 to 100	%	REAL	STOPPED
Array of user defined frequency for V/f control.						
VHZ USER FREQ[6]	140	60	0 to 100	%	REAL	STOPPED
Array of user defined frequency for V/f control.						
VHZ USER FREQ[7]	141	70	0 to 100	%	REAL	STOPPED
Array of user defined frequency for V/f control.						
VHZ USER FREQ[8]	142	80	0 to 100	%	REAL	STOPPED
Array of user defined frequency for V/f control.						
VHZ USER FREQ[9]	143	90	0 to 100	%	REAL	STOPPED
Array of user defined frequency for V/f control.						
VHZ USER FREQ[10]	144	100	0 to 100	%	REAL	STOPPED
Array of user defined frequency for V/f control.						
VHZ USER VOLTS[0]	146	0	0 to 100	%	REAL	STOPPED
Array of VHz User Volts for V/f control.						
VHZ USER VOLTS[1]	147	10	0 to 100	%	REAL	STOPPED
Array of VHz User Volts for V/f control.						
VHZ USER VOLTS[2]	148	20	0 to 100	%	REAL	STOPPED
Array of VHz User Volts for V/f control.						
VHZ USER VOLTS[3]	149	30	0 to 100	%	REAL	STOPPED
Array of VHz User Volts for V/f control.						
VHZ USER VOLTS[4]	150	40	0 to 100	%	REAL	STOPPED
Array of VHz User Volts for V/f control.						
VHZ USER VOLTS[5]	151	50	0 to 100	%	REAL	STOPPED
Array of VHz User Volts for V/f control.						
VHZ USER VOLTS[6]	152	60	0 to 100	%	REAL	STOPPED
Array of VHz User Volts for V/f control.						
VHZ USER VOLTS[7]	153	70	0 to 100	%	REAL	STOPPED
Array of VHz User Volts for V/f control.						
VHZ USER VOLTS[8]	154	80	0 to 100	%	REAL	STOPPED
Array of VHz User Volts for V/f control.						
VHZ USER VOLTS[9]	155	90	0 to 100	%	REAL	STOPPED
Array of VHz User Volts for V/f control.						
VHZ USER VOLTS[10]	156	100	0 to 100	%	REAL	STOPPED
Array of VHz User Volts for V/f control.						

Function Block Outputs

Parameter Name	No.	Default Value	Range	Units	Type	Writable
VSD DEMAND	157	0		%	REAL	NOT
The amount of voltage applied in the direct or flux axis						
VSQ DEMAND	158	0		%	REAL	NOT
The amount of voltage applied in the quadrature or torque axis						

Functional Description

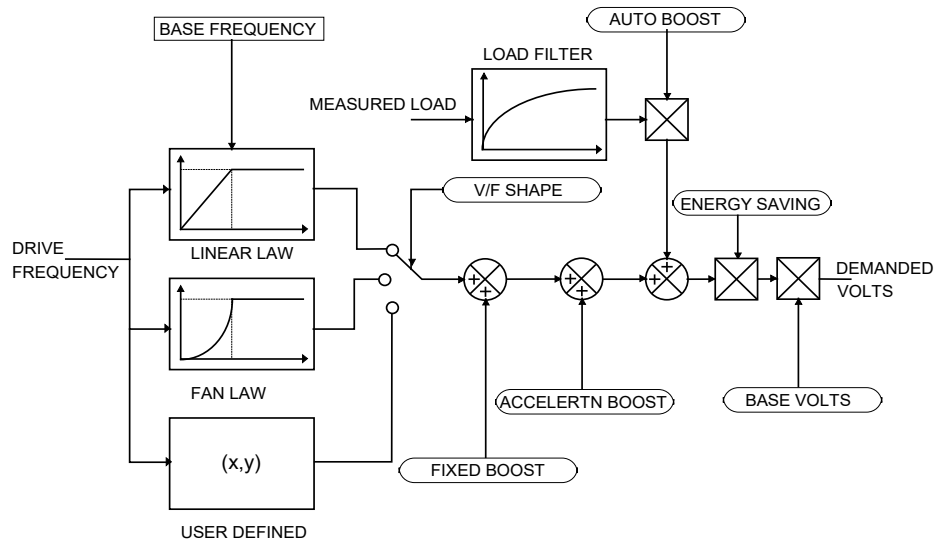

V/F Shape

The function allows the user to parameterize the Drive's conventional V/F motor fluxing scheme. Three V/F shapes are available, LINEAR LAW, FAN LAW and USER DEFINED:

- Linear Law V/F shape should be used in applications requiring constant motor torque though out the speed range (e.g. machine tools or hoists).
- Fan Law V/F shape provides less torque capabilities for lower speeds, which means some energy savings can be achieved for fan or pump applications when they operate at lower speed/load setpoints. When choosing fan law shape the user should carefully consider if such profile is suitable for the overall load cycle of their application.
- User Defined V/F shape provides a method for the user to define any profile. 10 user definable (x,y) points are provided. Linear interpolation is used between each point. The drive also assumes the following points - (0%,0%) and (100%,100%) - though these may be overridden. For example, (USER FREQ 1 = 0%, USER VOLTAGE 1 = 5%) takes precedence over (0%, 0%).

For any of these V/F shapes the **Base Frequency** parameter (in the Motor Nameplate function) which is the value of Drive output frequency at which maximum output volts is provided, can be set by the user.

Boost Parameters

- Correct no-load motor fluxing at low Drive output frequencies can be achieved by setting the **Fixed Boost** parameter.
- Correct motor fluxing under load conditions is achieved by setting the **Auto Boost** parameter. The motor is correctly fluxed when the **Actual Field Current** diagnostic in the Feedbacks function reads 100.0% .
- Additional **Fixed Boost** can be applied during acceleration by setting the **Accel Boost** parameter. This can be useful for starting heavy/high stiction loads.

Saving Energy

An **Energy Saving** mode is provided to allow the user to choose to optimize energy consumption under low load, steady state conditions. As soon as the load is increased or acceleration is required, the drive suspends energy saving mode, and returns to it only if the load conditions are such that it is allowed to do so. If enabled, energy saving mode reduces the voltage of the motor to a level required to maintain the setpoint speed at a low load. For sustained low load conditions it is not necessary to keep the motor fluxed for rated torque capabilities, so the motor voltage is reduced to a level that will still provide required torque. This operation on the cusp of required torque has limitations in terms of response to speed or load changes. The energy saving algorithm monitors torque demand, and as soon as it detects a rise in demand the drive switches from energy saving mode to normal mode of operation. However, sudden increases in load may be too fast and may lead to stall or trip conditions. This will occur if the time to correctly re-flux the motor takes longer than the time of load increase. There can be a window of time when the motor is simply not able to generate sufficient torque necessary for the new, increased load conditions.

Energy saving mode should ideally be used in applications where there are prolonged periods of low load operation, with no fast excursions towards rated torque. The user always has to be certain that the overall load cycle for their application would still be correctly serviced if the energy saving mode is enabled, and that energy saving mode is not being incorrectly used at the expense of required performance

Flycatching

Overview

Only available if Induction Motor selected in **Motor Type**, this feature performs a directional speed search. It allows the drive to seamlessly catch a spinning motor before controlling the motor to the desired setpoint. This is especially useful for large inertia fan loads, where drafts in building air ducts can cause a fan to 'windmill'.

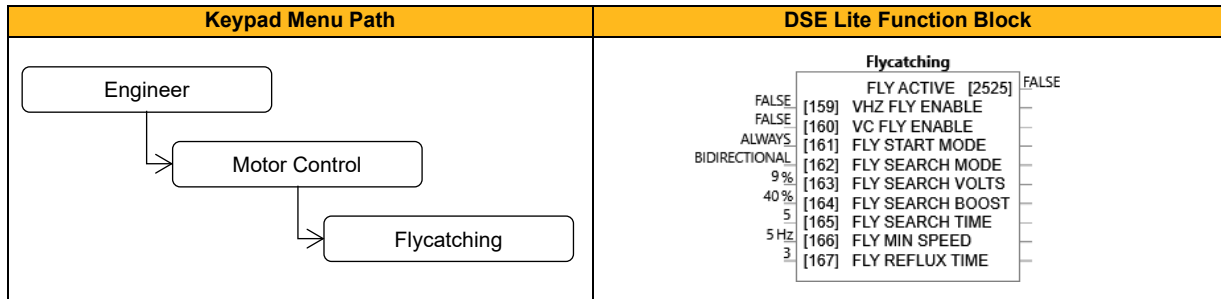

Function Block Inputs

Parameter Name	No.	Default Value	Range	Units	Type	Writable
VHZ FLY ENABLE	159	FALSE			BOOL	ALWAYS
Enables flycatching in V/Hz control mode when TRUE. Note: During active flycatching P0231 'MSEQ Main State' will show state MSEQ_STATE_PRE_RUNNING (=4), when complete the state changes to MSEQ_STATE_NORMAL_RUNNING (=5). P2525 'Fly active' is set to TRUE while flycatching sequence is active.						
VC FLY ENABLE	160	FALSE			BOOL	ALWAYS
Enable flycatching in Vector control mode when TRUE. Note: During active flycatching P0231 'MSEQ Main State' will show MSEQ_STATE_PRE_RUNNING (=4), when complete the state changes to MSEQ_STATE_NORMAL_RUNNING (=5). P2525 'Fly active' is set to TRUE while flycatching sequence is active. Note: In sensorless vector control mode flycatching will only work correctly if the motor continues to run in the same direction (same speed setpoint sign as actual motor rotation direction).						
FLY START MODE	161	0: Always	0: Always 1: Trip or Power Up 2: Trip		ENUM	ALWAYS
Refines the choice for when the flycatching feature is enabled.						
FLY SEARCH MODE	162	0: Bidirectional	0: Bidirectional 1: Unidirectional		ENUM	ALWAYS
The type of speed search carried out by the flycatching sequence.						
FLY SEARCH VOLTS	163	9	0 to 100	%	REAL	ALWAYS
The percentage level of the search volts applied to the motor during the speed search phase of the flycatching sequence. Increasing this parameter improves the accuracy of the discovered motor speed but increases the braking influence of the speed search on the rotating motor.						
FLY SEARCH BOOST	164	40	0 to 50	%	REAL	ALWAYS
The level of search boost applied to the motor during the speed search phase of the flycatching sequence.						
FLY SEARCH TIME	165	5	0.1 to 60		TIME	ALWAYS
The search rate during the speed search phase of the flycatching sequence. Performing the flycatching speed search too quickly can cause the drive to inaccurately identify the motor speed. Refluxing at an inaccurate motor speed can cause the drive to trip on overvoltage. If this occurs, increasing this parameter will reduce the risk of tripping.						
FLY MIN SPEED	166	5	0 to 500	Hz	REAL	ALWAYS
The lowest search speed before the speed search phase of the flycatching sequence is considered to have failed.						
FLY REFLUX TIME	167	3	0.1 to 10		TIME	ALWAYS
The rate of rise of volts from the search level to the working level after a successful speed search. Refluxing the motor too quickly can cause the Drive to trip on either overvoltage or overcurrent. In either case, increasing this parameter will reduce the risk of tripping.						

Function Block Outputs

Parameter Name	No.	Default Value	Range	Units	Type	Writable
FLY ACTIVE	2525	FALSE			BOOL	NOT
A diagnostic output indicating whether the flycatching sequence is active.						

Functional Description

The flycatching function enables the drive to be restarted smoothly into a spinning motor. It applies small search voltages to the motor whilst ramping the Drive frequency from maximum speed to zero. When the motor load goes from motoring to regenerating, the speed search has succeeded and is terminated. If the search frequency falls below the minimum search speed, the speed search has failed and the Drive will ramp to the speed setpoint from zero.

The flycatching sequence can be triggered by different starting conditions:

ALWAYS:	All starts (after controlled/uncontrolled stop, or after a power-up)
TRIP or POWER-UP:	After uncontrolled stop, i.e. trip or coast, or after a power-up
TRIP:	After uncontrolled stop, i.e. trip or coast

The type of speed sequence may be Bidirectional or Unidirectional:

Bidirectional

Initially, the search is performed in the direction of the speed setpoint. If the drive fails to identify the motor speed in this direction, a second speed search is performed in the reverse direction.

Unidirectional

The search is performed only in the direction of the speed setpoint

Induction Motor

Overview

Motor nameplate parameters. Only if Induction Motor selected in **Motor Type**

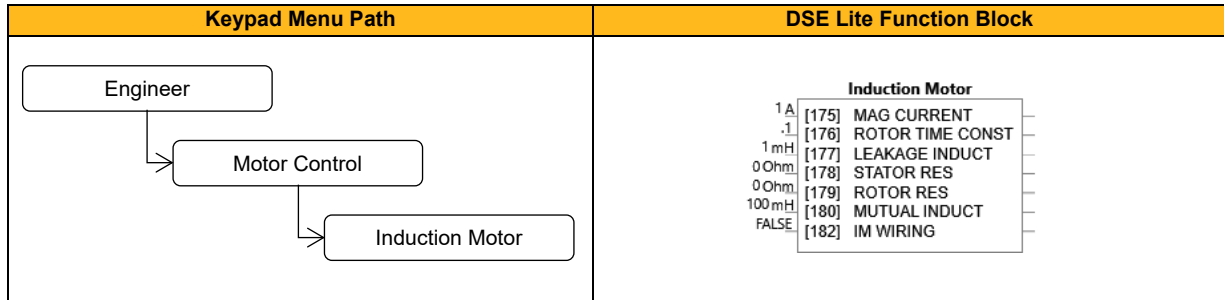

Function Block Inputs

Parameter Name	No.	Default Value	Range	Units	Type	Writable
MAG CURRENT	175	1	0.05 to 10000	A	REAL	ALWAYS
A current in the induction motor, defined as rotor flux / magnetizing inductance, often given the title "imr" (magnetization current). The autotune sequence will measure (rotating ATN) or calculated (stationary ATN) and automatically set this value. Please note that during this process the maximum value will be limited to 0.661 x motor (nameplate) rated current, so as to have at least 75% of rated motor current available for torque generation. When running larger motors with an undersized inverter the motor rated current parameter P0222 needs to be set to the drive rated current, not motor rated current. Maximum possible magnetizing current value is the lower of 100% motor current or stack max current. For stationary autotune, the calculated value (before limiting) is: $imr = \text{motor nameplate_rated_current} (P222) * \sqrt{1 - \text{nameplate_powerfactor}(P228)^2}$						
ROTOR TIME CONST	176	.1	0.005 to 100		TIME	ALWAYS
Induction Motor rotor time constant. Will be calculated by an Autotune.						
LEAKAGE INDUCT	177	1	0.001 to 1000	mH	REAL	ALWAYS
Calculated by Autotune: Induction motor leakage inductance. Displayed as star equivalent value.						
STATOR RES	178	0.0001	0.0001 to 100	Ohm	REAL	ALWAYS
Calculated by Autotune: Induction motor stator resistance. Displayed as star or delta equivalent value according to "motor connection" setting.						
ROTOR RES	179	0.0001	0.0001 to 100.00	Ohm	REAL	ALWAYS
Induction motor rotor resistance. Displayed as an interim "by-product" of stationary autotune procedure. Not used in control functions.						
MUTUAL INDUCT	180	100	0.01 to 10000	mH	REAL	ALWAYS
Calculated by Autotune: Induction motor mutual (magnetizing) inductance. Displayed as star equivalent.						
IM WIRING	182	FALSE			BOOL	STOPPED
Wiring direction of the motor phases (U-V-W or U-W-V). A setting of false indicates that the motor phases are wired in the usual U-V-W sequence. A setting of true indicates U-W-V. this parameter is useful to reverse the direction of motor rotation without the need for physical rewiring.						

Inj Braking

Overview

Designed for V/Hz Motor Control Mode, the injection braking feature provides a method of stopping spinning induction motors without returning the kinetic energy of the motor and load back into the dc link of the drive. This is achieved by running the motor highly inefficiently so that all the energy stored in the load is dissipated in the motor. Thus, high inertia loads can be stopped without the need for an external dynamic braking resistor.

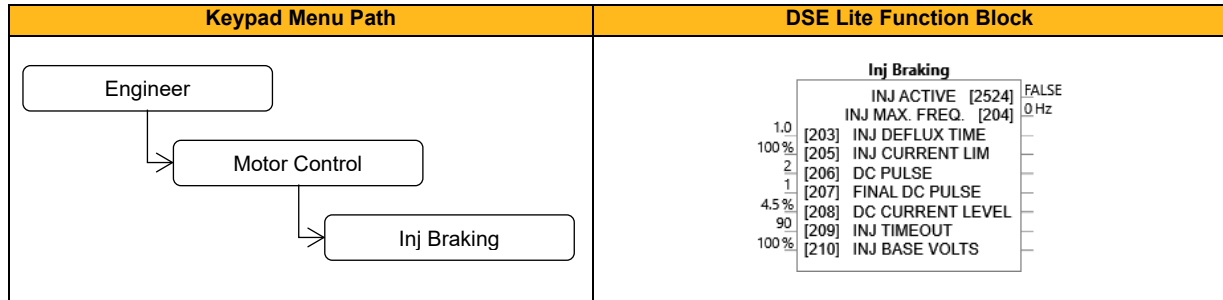

Function Block Inputs

Parameter Name	No.	Default Value	Range	Units	Type	Writable
INJ DEFLUX TIME	203	1.0	0.1 to 20.0		TIME	ALWAYS
Motor defluxed duration (assuming 100% voltage =100% speed) before calculated cyclic and frozen when starting injection braking. Lower limit for effective deflux time is 0.125s.						
INJ CURRENT LIM	205	100	50 to 150	%	REAL	ALWAYS
Limit level of motor current applied during low frequency injection braking. Unit normally is % rated motor current but for motors with rated current P0222 higher than the drive (stack) rated current the unit used is % stack current. If current limit parameter P0054 (Motor current limit %) is lower than Inj Current Lim, Motor Current Limit shall be used as the limit for barking current. To avoid a possible Trip 9 (low speed l) during injection braking with a big motor this parameter should be kept below or equal to 100%.						
DC PULSE	206	2	0.1 to 100		TIME	ALWAYS
The max duration of the DC pulse applied to the motor when injection braking is required for motor speeds below 20% of base speed. Effective duration is DC Pulse value*speed at braking start / 20% of base speed.						
FINAL DC PULSE	207	1	0.1 to 10		TIME	ALWAYS
The duration of the final dc holding pulse applied to the motor after either low frequency injection braking or timed DC Pulse.						
DC CURRENT LEVEL	208	4.5	0 to 25	%	REAL	ALWAYS
The level of DC pulse applied to the motor during either the timed or final dc pulse. Value given is the applied percentage of nominal motor voltage. The drive might trip with overcurrent if the value is chosen too high. Inj braking current limit or user current limit is not active in the dc pulse phase. If value is chosen too low the resulting current flowing is (too) low and the motor might not come to braked standstill.						
INJ TIMEOUT	209	90	0 to 600		TIME	ALWAYS
Maximum overall time in the low frequency injection braking state. If time is overrun the final DC current pulse is applied.						
INJ BASE VOLTS	210	100	0.1 to 115.47	%	REAL	ALWAYS
The maximum volts (and voltage scale factor) at base speed applied to the motor during low frequency injection braking. Usually this limit will never be reached due to active current and frequency limits. When in current limit during low frequency injection braking this value may be used to change the applied frequency. The value should be adjusted down if the configured rated motor current is low and low frequency injection braking is aborted early (due too noisy current feedback) or it may need to be increased if the current limit is not reached e.g. at low speed operation.						

Function Block Outputs

Parameter Name	No.	Default Value	Range	Units	Type	Writable
INJ. ACTIVE	2524	FALSE			BOOL	NOT
Indicates the state of the drive. TRUE when injection braking is ON.						
INJ MAX FREQUENCY	204	0		Hz	REAL	NOT
Value of the maximum frequency applied to the motor for low frequency injection braking mode. The value is updated at the start of injection braking based on current motor speed. The actual frequency applied to the motor can be monitored on parameter P0118 Elec Rotor Speed.						

Note: Re-applying the **0490 Run Forward** or **0491 Run Reverse** signal while injection braking is active will result in the inverter coasting to stop, restarting only when zero speed has been reached.

Keypad

Overview

Configuration of the basic settings of the keypad.

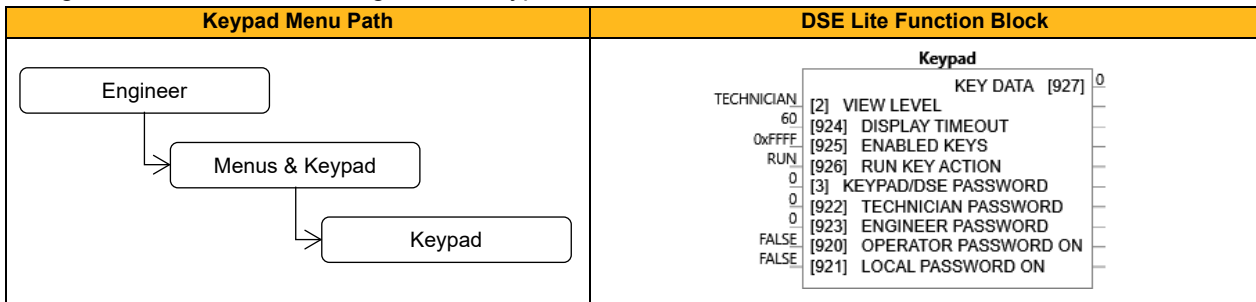

Function Block Inputs

Parameter Name	No.	Default Value	Range	Units	Type	Writable
VIEW LEVEL	2	1: Technician	0: Operator 1: Technician 2: Engineer		ENUM	ALWAYS
The view level may be used as a convenient method to hide more advanced menus and parameters.						
DISPLAY TIMEOUT	924	0	0 to 86400		TIME	ALWAYS
When the keypad is idle, (no keys pressed), for a period longer than the Display Timeout, the display will automatically revert to the menu defined in the Startup Page parameter. A value of 0 disables this feature.						
ENABLED KEYS	925	0xFFFF	0: Up 1: Down 2: E 3: M 4: Direction (6901 Only) 5: Jog (6901 Only) 6: Local/Remote (6901 Only) 7: Start 8: Stop 9: Prog (6901 Only)		WORD	ALWAYS
May be used to disable one or more keys. The UP, DOWN, E, M and STOP keys cannot be disabled. Direction = bit 4. Jog = bit 5. Local/Remote = bit 6. Start = bit 7. PROG = bit 9. For example, setting a value of FF7F will disable the start key.						
RUN KEY ACTION	926	0: RUN	0: RUN 1: JOG		ENUM	STOPPED
Defines the use of the green start key in local mode.						
KEYPAD/DSE PASSWORD	3	0			WORD	ALWAYS
Defines the password (in HEX) to be entered to allow modification to parameters using the keypad. This password does not affect access via the web page, but it's also used for DSE Lite. A value of 0000, (the default value), inhibits the password feature. Entering a value other than 0000 causes the keypad to prompt for the password before proceeding to the parameter edit mode.						
TECHNICIAN PASSWORD	922	0			WORD	ALWAYS
Value required to allow the view level to be changed from OPERATOR to TECHNICIAN. A value of 0000 disables the password.						
ENGINEER PASSWORD	923	0			WORD	ALWAYS
Value required to allow the view level to be changed to ENGINEER. A value of 0000 disables the password.						
OPERATOR PASSWORD ON	920	FALSE			BOOL	ALWAYS
When the Keypad Password is active this parameter may be used to selectively defeat the password feature in the Operator menu. By default this parameter is FALSE, meaning that the password is ignored when modifying Operator menu parameters.						
LOCAL PASSWORD ON	921	FALSE			BOOL	ALWAYS
When the Keypad Password is active this parameter may be used to selectively defeat the password feature for the local setpoint. By default this parameter is FALSE, meaning that the password is ignored when modifying the local setpoint and other related parameters.						

Function Block Outputs

Parameter Name	No.	Default Value	Range	Units	Type	Writable
KEY DATA	927	0: 0	0: Up 1: Down 2: E 3: M 4: Direction (6901 Only) 5: Jog (6901 Only) 6: Local/Remote (6901 Only) 7: Start 8: Stop 9: Prog (6901 Only) 10: - ... 15: -		WORD	NOT
Bitfield showing which keys are currently pressed. For use in the application.						

Local Control

Overview

These parameters configure the functionality of the HMI keys for local start / stop control of the drive.

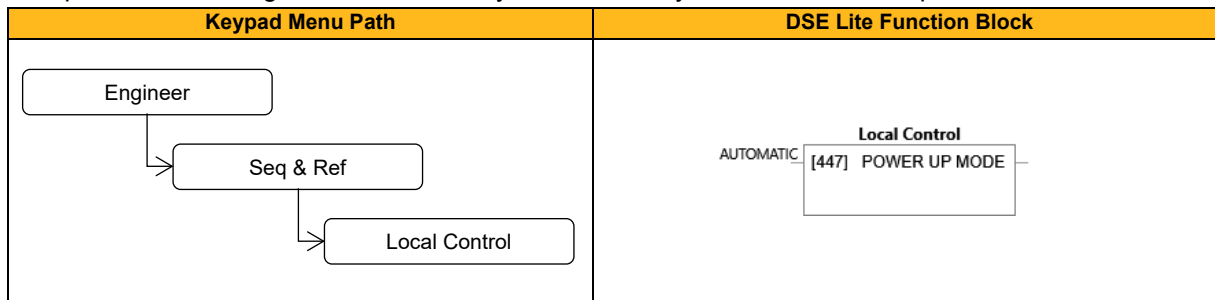

Function Block Inputs

Parameter Name	No.	Default Value	Range	Units	Type	Writable
POWER UP MODE	447	0: Automatic	0: Automatic 1: Local 2: Remote		ENUM	ALWAYS
Determines if the Drive is in Local mode or Remote mode at power-up. If set to automatic, the Drive will assume the local/remote mode set at last power down.						

Logic Functions (Logic Func 1 – 30)

Overview

These generic function blocks can be configured to perform one of a number of simple functions upon a fixed number of inputs.

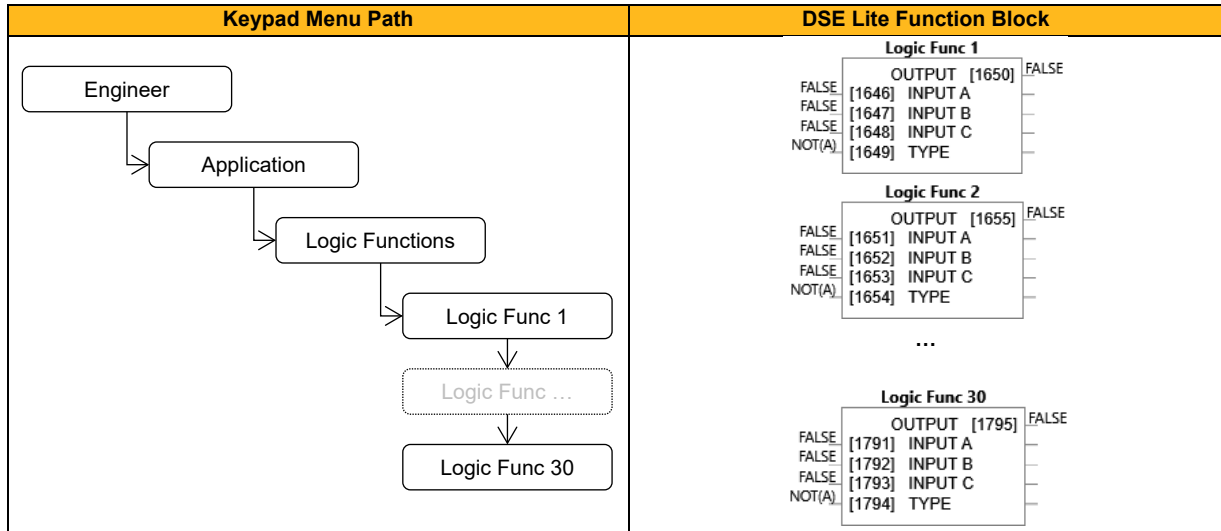

Function Block Inputs

Parameter Name	No.	Default Value	Range	Units	Type	Writable
INPUT A						
Logic Func 1	1646	FALSE			BOOL	ALWAYS
Logic Func 2	1651	FALSE			BOOL	ALWAYS
...	...					
Logic Func 30	1791	FALSE			BOOL	ALWAYS
General purpose logic input.						
INPUT B						
Logic Func 1	1647	FALSE			BOOL	ALWAYS
Logic Func 2	1652	FALSE			BOOL	ALWAYS
...	...					
Logic Func 30	1792	FALSE			BOOL	ALWAYS
General purpose logic input.						
INPUT C						
Logic Func 1	1648	FALSE			BOOL	ALWAYS
Logic Func 2	1653	FALSE			BOOL	ALWAYS
...	...					
Logic Func 30	1793	FALSE			BOOL	ALWAYS
General purpose logic input.						
TYPE						
Logic Func 1	1649	0: NOT(A)	0: NOT(A)		ENUM	ALWAYS
Logic Func 2	1654	0: NOT(A)	1: AND(A,B,C)		ENUM	ALWAYS
...	...		2: NAND(A,B,C)			
Logic Func 30	1794	0: NOT(A)	3: OR(A,B,C)		ENUM	ALWAYS
			4: NOR(A,B,C)			
			5: XOR(A,B)			
			6: 0-1 EDGE(A)			
			7: 1-0 EDGE(A)			
			8: AND(A,B,IC)			
			9: OR(A,B,IC)			
			10: S FLIP-FLOP			
			11: R FLIP-FLOP			
			12: LATCH			
			13: SWITCH			
			14: (A AND B) OR C			
			15: (A OR B) AND C			
The operation to be performed on the three inputs to produce the output value.						

Function Block Outputs

Parameter Name	No.	Default Value	Range	Units	Type	Writable
OUTPUT						
Logic Func 1	1650	FALSE			BOOL	NOT
Logic Func 2	1655	FALSE			BOOL	NOT
...	...					
Logic Func 30	1795	FALSE			BOOL	NOT
The result of performing the selected operation on the inputs.						

Functional Description

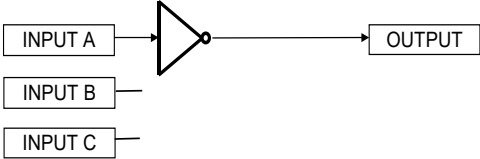
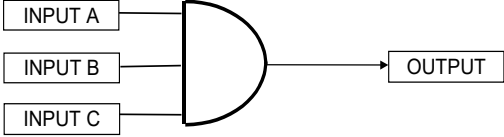
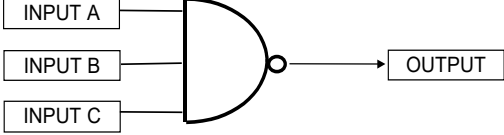
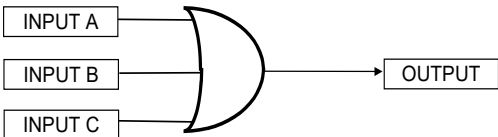
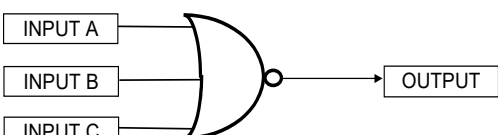
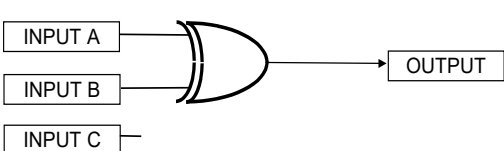
Operation	Description
NOT(A)	<p>NOT(A)</p>  <p>If INPUT A is TRUE the OUTPUT is FALSE, otherwise the OUTPUT is TRUE.</p>
AND(A,B,C)	<p>AND(A,B,C)</p>  <p>If A and B and C are all TRUE then the OUTPUT is TRUE, otherwise the OUTPUT is FALSE.</p>
NAND(A,B,C)	<p>NAND(A,B,C)</p>  <p>If A and B and C are all TRUE then the OUTPUT is FALSE, otherwise the OUTPUT is TRUE.</p>
OR(A,B,C)	<p>OR(A,B,C)</p>  <p>If at least one of A or B or C is TRUE then the OUTPUT is TRUE, otherwise the OUTPUT is FALSE.</p>
NOR(A,B,C)	<p>NOR(A,B,C)</p>  <p>If at least one of A or B or C is TRUE then the OUTPUT is FALSE, otherwise the OUTPUT is TRUE.</p>
XOR(A,B)	<p>XOR(A,B)</p>  <p>If A and B are the same, (both TRUE or both FALSE), then the output is FALSE, otherwise the output is TRUE.</p>

Operation	Description
-----------	-------------

0-1 EDGE(A)

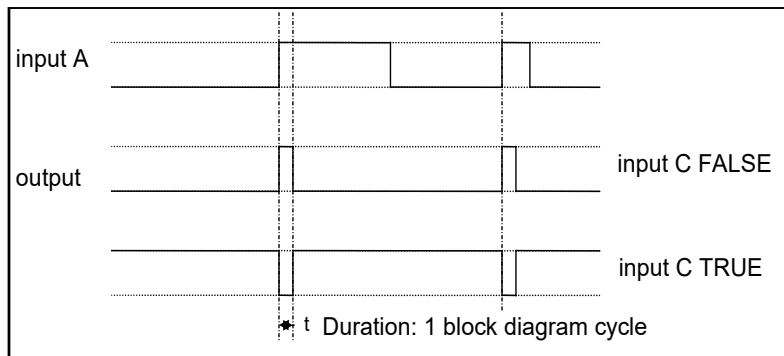

Rising Edge Trigger

Input B is not used.

This function outputs a pulse of 5ms duration when INPUT A to the block becomes TRUE. When INPUT C is TRUE, the output is inverted.

The output is held TRUE for one execution of the function block diagram.

1-0 EDGE(A)

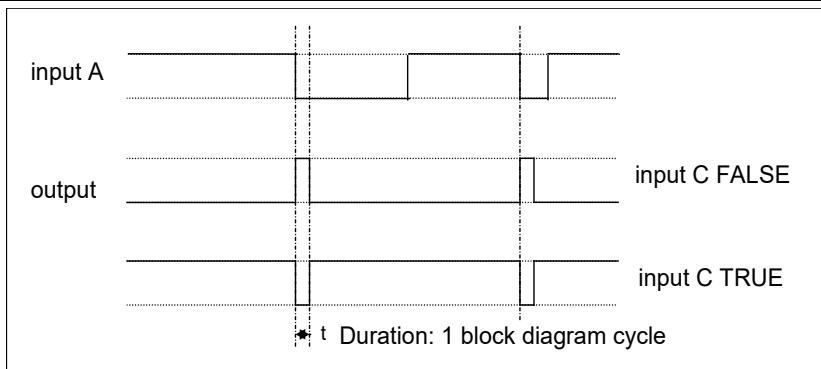

Falling Edge Trigger

Input B is not used.

This function outputs a pulse of 20ms duration when INPUT A to the block becomes FALSE. When INPUT C is TRUE, the output is inverted.

The output is held TRUE for one execution of the function block diagram.

AND(A,B,!C)

AND(A,B,!C)

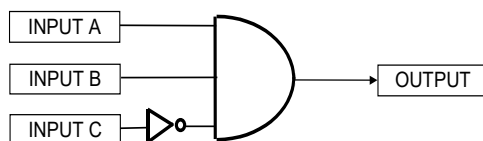

Input State

A	B	C	Output State
0	0	0	0
0	0	1	0
0	1	0	0
0	1	1	0
1	0	0	0
1	0	1	0
1	1	0	1
1	1	1	0

Refer to the Truth Table.

FALSE = 0, TRUE = 1.

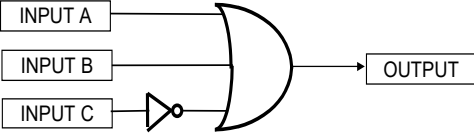
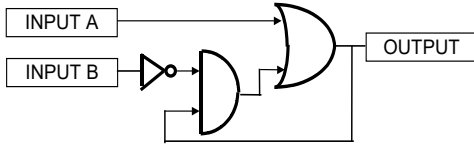
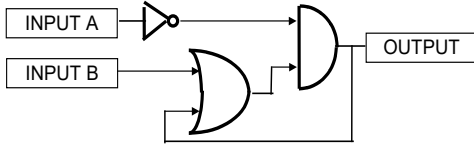
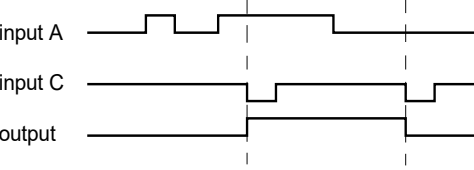
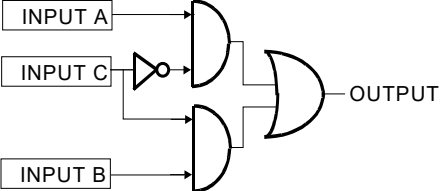
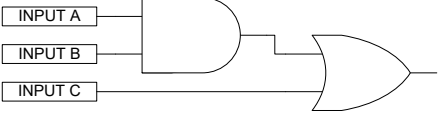
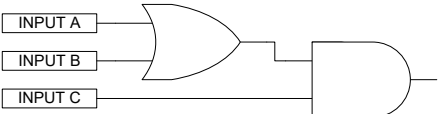
Operation	Description																																							
OR(A,B,!C)	<p>OR(A,B,!C)</p>  <p>Refer to the Truth Table. FALSE = 0, TRUE = 1.</p> <table border="1" data-bbox="932 237 1262 584"> <thead> <tr> <th colspan="3">Input State</th> <th rowspan="2">Output State</th> </tr> <tr> <th>A</th> <th>B</th> <th>C</th> </tr> </thead> <tbody> <tr><td>0</td><td>0</td><td>0</td><td>1</td></tr> <tr><td>0</td><td>0</td><td>1</td><td>0</td></tr> <tr><td>0</td><td>1</td><td>0</td><td>1</td></tr> <tr><td>0</td><td>1</td><td>1</td><td>1</td></tr> <tr><td>1</td><td>0</td><td>0</td><td>1</td></tr> <tr><td>1</td><td>0</td><td>1</td><td>1</td></tr> <tr><td>1</td><td>1</td><td>0</td><td>1</td></tr> <tr><td>1</td><td>1</td><td>1</td><td>1</td></tr> </tbody> </table>	Input State			Output State	A	B	C	0	0	0	1	0	0	1	0	0	1	0	1	0	1	1	1	1	0	0	1	1	0	1	1	1	1	0	1	1	1	1	1
Input State			Output State																																					
A	B	C																																						
0	0	0	1																																					
0	0	1	0																																					
0	1	0	1																																					
0	1	1	1																																					
1	0	0	1																																					
1	0	1	1																																					
1	1	0	1																																					
1	1	1	1																																					
S FLIP-FLOP	<p>S FLIP-FLOP</p>  <p>This is a set dominant flip-flop. INPUT A functions as <i>set</i>, and INPUT B as <i>reset</i>.</p>																																							
R FLIP-FLOP	<p>R FLIP-FLOP</p>  <p>This is a reset dominant flip-flop. INPUT A functions as <i>reset</i>, and INPUT B as <i>set</i>.</p>																																							
LATCH	 <p>When INPUT C is low, the output is the value of INPUT A. This output value is then latched until INPUT C is low again. INPUT B is not used.</p>																																							
SWITCH	 <p>When INPUT C is FALSE, the output is equal to INPUT A. When INPUT C is TRUE, the output is equal to INPUT B.</p>																																							
(A AND B) OR C	 <p>Refer to the truth table FALSE = 0, TRUE = 1.</p> <table border="1" data-bbox="932 1391 1262 1637"> <thead> <tr> <th>A</th> <th>B</th> <th>C</th> <th>Output</th> </tr> </thead> <tbody> <tr><td>0</td><td>0</td><td>0</td><td>0</td></tr> <tr><td>0</td><td>0</td><td>1</td><td>1</td></tr> <tr><td>0</td><td>1</td><td>0</td><td>0</td></tr> <tr><td>0</td><td>1</td><td>1</td><td>1</td></tr> <tr><td>1</td><td>0</td><td>0</td><td>0</td></tr> <tr><td>1</td><td>0</td><td>1</td><td>1</td></tr> <tr><td>1</td><td>1</td><td>0</td><td>1</td></tr> <tr><td>1</td><td>1</td><td>1</td><td>1</td></tr> </tbody> </table>	A	B	C	Output	0	0	0	0	0	0	1	1	0	1	0	0	0	1	1	1	1	0	0	0	1	0	1	1	1	1	0	1	1	1	1	1			
A	B	C	Output																																					
0	0	0	0																																					
0	0	1	1																																					
0	1	0	0																																					
0	1	1	1																																					
1	0	0	0																																					
1	0	1	1																																					
1	1	0	1																																					
1	1	1	1																																					
(A OR B) AND C	 <p>Refer to the truth table FALSE = 0, TRUE = 1.</p> <table border="1" data-bbox="932 1637 1262 1883"> <thead> <tr> <th>A</th> <th>B</th> <th>C</th> <th>Output</th> </tr> </thead> <tbody> <tr><td>0</td><td>0</td><td>0</td><td>0</td></tr> <tr><td>0</td><td>0</td><td>1</td><td>0</td></tr> <tr><td>0</td><td>1</td><td>0</td><td>0</td></tr> <tr><td>0</td><td>1</td><td>1</td><td>1</td></tr> <tr><td>1</td><td>0</td><td>0</td><td>0</td></tr> <tr><td>1</td><td>0</td><td>1</td><td>1</td></tr> <tr><td>1</td><td>1</td><td>0</td><td>0</td></tr> <tr><td>1</td><td>1</td><td>1</td><td>1</td></tr> </tbody> </table>	A	B	C	Output	0	0	0	0	0	0	1	0	0	1	0	0	0	1	1	1	1	0	0	0	1	0	1	1	1	1	0	0	1	1	1	1			
A	B	C	Output																																					
0	0	0	0																																					
0	0	1	0																																					
0	1	0	0																																					
0	1	1	1																																					
1	0	0	0																																					
1	0	1	1																																					
1	1	0	0																																					
1	1	1	1																																					

Minimum Speed

Overview

The minimum speed block is used to determine how the inverter will follow a reference. There are two modes: Proportional (minimum limit) and Linear (between min and max.)

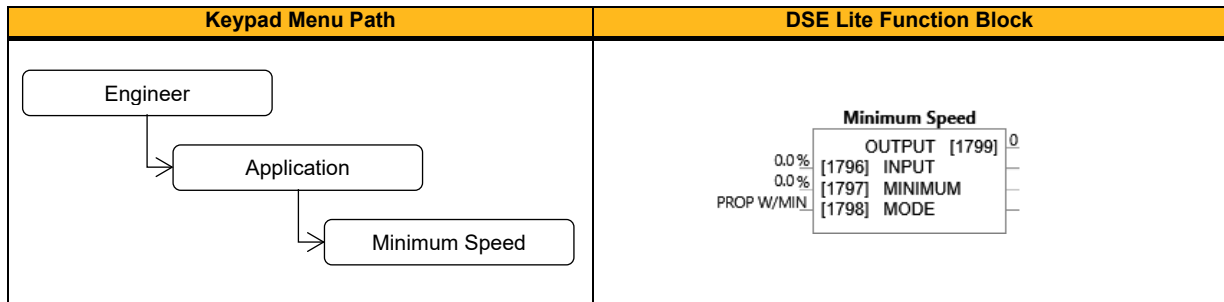

Function Block Inputs

Parameter Name	No.	Default Value	Range	Units	Type	Writable
INPUT	1796	0.0	-300.0 to 300.0	%	REAL	ALWAYS
Reference value, which shall be clamped by the function block.						
MINIMUM	1797	0.0	-100.0 to 100.0	%	REAL	ALWAYS
Determines the minimum output value for this block.						
MODE	1798	0: Prop W/Min	0: Prop W/Min 1: Linear		ENUM	ALWAYS
Determines the operating mode of the block (clamped by PROP W/MIN or rescaled by LINEAR).						

Function Block Outputs

Parameter Name	No.	Default Value	Range	Units	Type	Writable
OUTPUT	1799	0			REAL	NOT
Clamped output value.						

Functional Description

There are two operating modes for the Minimum Speed block:

Proportional with Minimum

In this mode the Minimum Speed block behaves like a simple clamp. The minimum value has the valid range -100% to 100% and the output is always greater than or equal to the minimum value.

Linear

In this mode the MINIMUM SPEED block first clamps the input to zero then rescales the input such that the output goes linearly between minimum and 100% for an input that goes from 0 to 100%.

Note the constraints:

- min >= 0
- input >= 0
- max = 100%

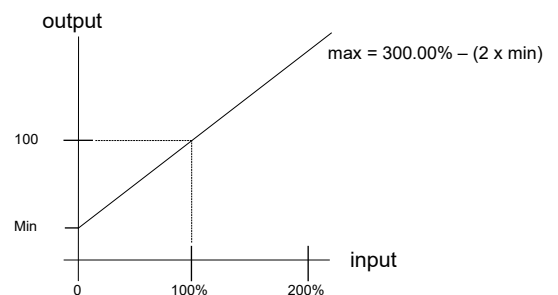

Modbus Mapping

Overview

Modbus TCP/IP holding registers are both read/write, therefore the Modbus mapping block has mapping entries only on the input side. Usually, Modbus communications to the inverter would write to/read from parameters directly in the block diagram, as each parameter in the inverter has a Modbus address.

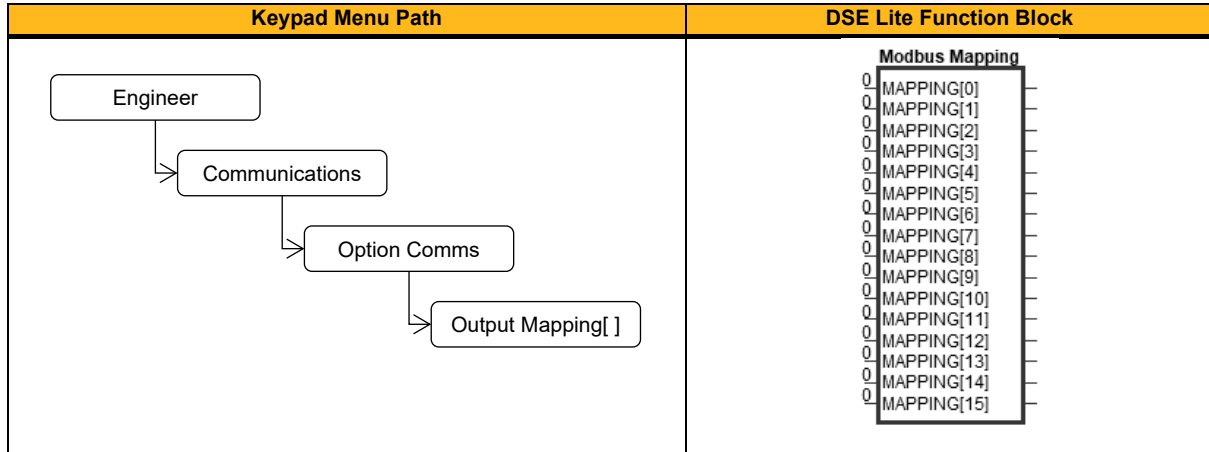

Function Block Outputs

Parameter Name	No.	Default Value	Range	Units	Type	Writable
MAPPING[0]	663	0			PREF	CONFIG
...	...					
MAPPING[31]	678					

Defines the cyclic (TxPDO and RxPDO) data output mapping table (16 entries). The value entered is the Tag ID of the parameter to be cyclically transferred. First 0 entry in parameter range 0663...0678 indicates the end of the table.
If the mapping is defined (written) by the PLC at least the first mapping entry on parameter 0663 must be 0.

Functional Description

The mapping blocks expect the TAG number of the required parameter. Therefore links are not accepted and the TAG number has to be entered directly. You can find a list of commonly used parameters below.

Parameter Name	No.	Type	Bytes	PLC R/W
Device State	0971	USINT	1	Write (Mapping Output)
Statusword	0507	WORD	2	Write (Mapping Output)
Reference	0462	REAL	4	Write (Mapping Output)
Speed rpm	0103	REAL	4	Write (Mapping Output)
Anin1 Value	0534	REAL	4	Write (Mapping Output)
Anin2 Value	0540	REAL	4	Write (Mapping Output)
Anout1 Value	0558	REAL	4	Write (Mapping Output)
Anout2 Value	0563	REAL	4	Write (Mapping Output)
Digin Word	0610	WORD	2	Write (Mapping Output)
Digout Word	0625	WORD	2	Write (Mapping Output)
Speed Demand	0460	REAL	4	Write (Mapping Output)
Speed Percent	0105	REAL	4	Write (Mapping Output)
Active Trip Hi	876	DWORD	4	Write (Mapping Output)
Active Trip Lo	877	DWORD	4	Write (Mapping Output)
Motor current (%)	111	REAL	4	Write (Mapping Output)
Stack current (%)	114	REAL	4	Write (Mapping Output)
Actual torque (%)	109	REAL	4	Write (Mapping Output)
Actual power (kW)	92	REAL	4	Write (Mapping Output)
Encoder speed (rev/s)	79	REAL	4	Write (Mapping Output)

Modbus TCP Config

Overview

The inverter includes a Modbus TCP server. The Modbus registers are mapped to the inverter's parameters. Up to 3 simultaneous connections to Modbus clients are possible. TCP port 502 is used.

If Modbus TCP is used as part of a process control, it is recommended a dedicated network be used with fixed IP addresses for the inverter.

To allow Modbus TCP connections to the inverter, the parameter **0656 Maximum Connections** must be set to a value greater than zero.

All inverter parameters are mapped to Holding and Input registers. There is no mapping to coils or discrete inputs.

Refer to the chapter 14 for further details.

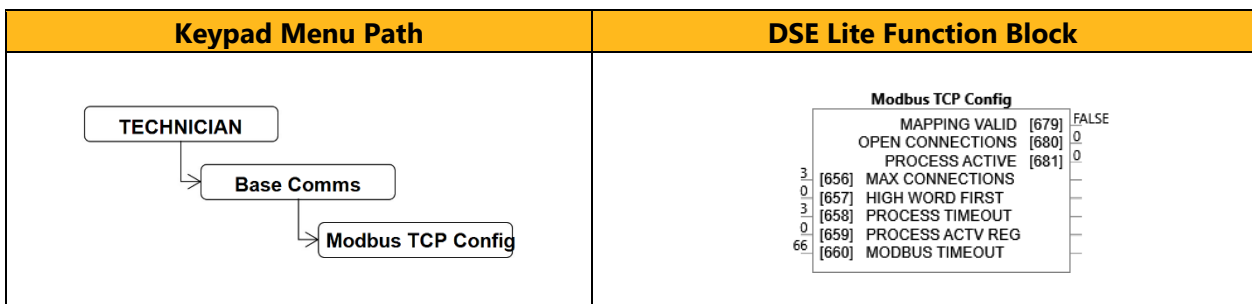

Function Block Inputs

Parameter Name	No.	Default Value	Range	Units	Type	Writable
MAX CONNECTIONS	656	0	0 to 3		USINT	ALWAYS
The maximum number of base Ethernet Modbus TCP connections allowed.						
HIGH WORD FIRST	657	0			BOOL	ALWAYS
The required base Ethernet Modbus TCP word order of 32-bit network data.						
PROCESS TIMEOUT	658	3	0 to 65		TIME	ALWAYS
The base Ethernet Modbus TCP process active timeout.						
PROCESS ACTV REG	659	0			UINT	ALWAYS
Register to read or write over Modbus to maintain process active.						
MODBUS TIMEOUT	660	66	0 to 100000		TIME	ALWAYS
The base Ethernet Modbus connection timeout.						

Function Block Outputs

Parameter Name	No.	Default Value	Range	Units	Type	Writable
MAPPING VALID	679	FALSE			BOOL	NOT
Diagnostic for the user-defined mapping of parameters to the base Modbus TCP.						
OPEN CONNECTIONS	680	0			USINT	NOT
Indicates the number of open base Ethernet Modbus TCP connections.						
PROCESS ACTIVE	681	0			BOOL	NOT
Indicates the base Ethernet Modbus TCP process active state.						

Motor Load

Overview

The **Motor Load** parameters determine the allowed level of motor overload. This can be especially useful when operating with motors smaller than the drive rating.

For an Induction Motor, an IxT protection is used and provides a current reduction if the max overload level is reached. The max overload level is calculated based on a 150% load for 60s.

For a PMAC motor, the motor load is calculated using the rated motor current and the thermal time constant (2 parameters of the PMAC motor module). The thermal time constant is used as the constant time of a simple 1st order low pass filter.

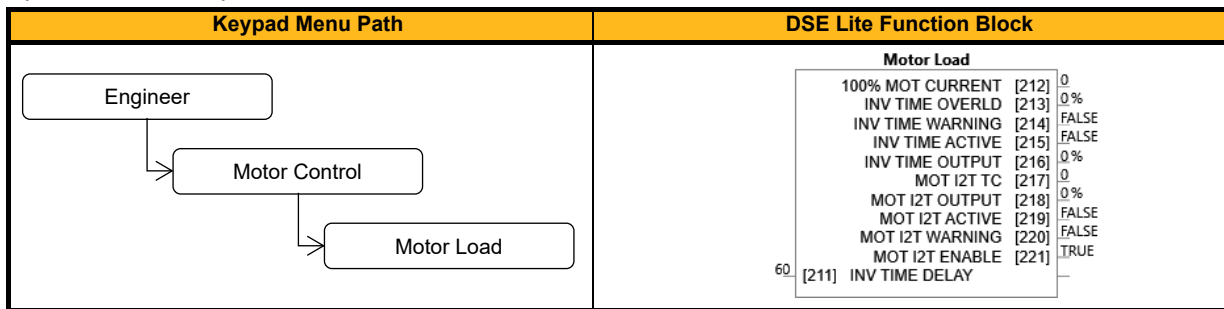

Function Block Inputs

Parameter Name	No.	Default Value	Range	Units	Type	Writable
INV TIME DELAY	211	60	6 to 60		TIME	ALWAYS
Overload time of the motor inverse time protection from cold state.						

Function Block Outputs

Parameter Name	No.	Default Value	Range	Units	Type	Writable
100% MOT CURRENT	212	0	0 to 10000		REAL	NOT
Motor current in Amps rms corresponding to 100% motor current.						
INV TIME OVERLD	213	0	0 to 500	%	REAL	NOT
Overload percentage of the motor inverse time protection.						
INV TIME WARNING	214	FALSE			BOOL	NOT
Output information. Becomes TRUE when the overload is 5% of the maximum value before reducing the current.						
INV TIME ACTIVE	215	FALSE			BOOL	NOT
Output information. Becomes TRUE when overload reaches 100% of the overload limit						
INV TIME OUTPUT	216	0	0 to 600	%	REAL	NOT
Actual output limit of the inverse time motor protection.						
MOT I2T TC	217	0	0 to 1000000		TIME	NOT
Time constant of the motor, defined in the PMAC Motor Data module.						
MOT I2T OUTPUT	218	0	0 to 600	%	REAL	NOT
Level of motor load in percent.						
MOT I2T ACTIVE	219	FALSE			BOOL	NOT
Level of motor load has reached 105%.						
MOT I2T WARNING	220	FALSE			BOOL	NOT
Level of motor load has reached 95%.						
MOT I2T ENABLE	221	TRUE			BOOL	NOT
Motor I2T protection is active.						

Functional Description

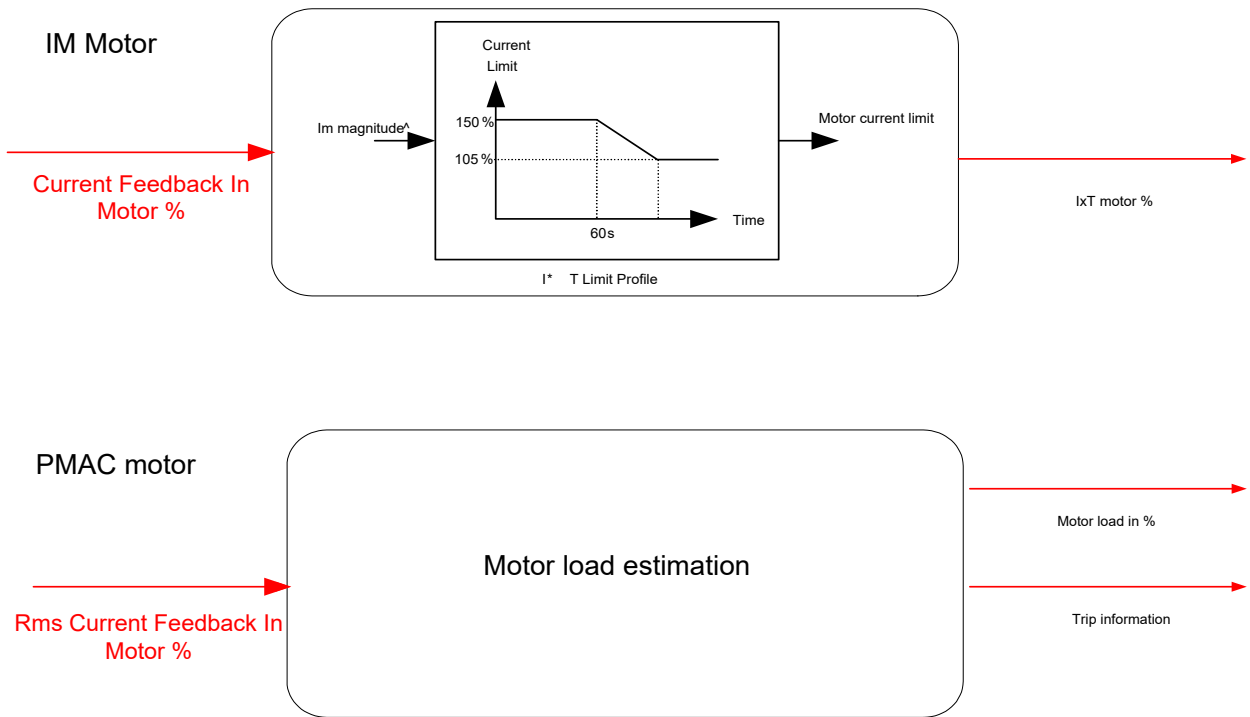

Motor Nameplate

Overview

Only available if Induction Motor selected in **Motor** Type, this block allows the entry of the motor data from available motor nameplate information. This data is required for correct operation of the inverter.

Refer to Induction Motor Data parameters which are determined by the Auto Tune feature for example the **Magnetising Current, Stator Resistance, Leakage Inductance, Mutual Inductance and Rotor Time Constant** for model parameters.

Do not attempt to control motors whose rated current is less than 35% of the drive rated current. Poor motor control or Autotune problems may occur if you do.

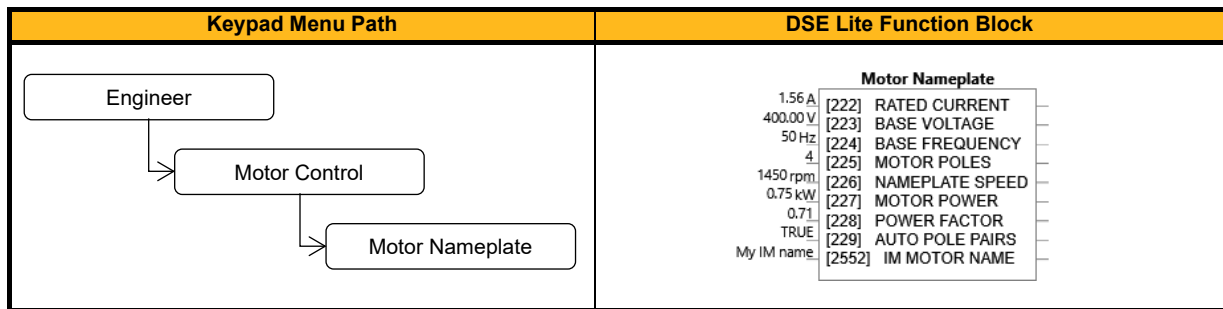

Function Block Inputs

Parameter Name	No.	Default Value	Range	Units	Type	Writable
RATED CURRENT	222	1.56	0.05 to 10000.0	A	REAL	STOPPED
Rated motor current on the name plate. Default inverter setting is 90% of rated inverter current.						
BASE VOLTAGE	223	400.00	1 to 1000	V	REAL	STOPPED
The rated motor voltage on the name plate. Attention: Changing parameter P1006 'Nominal Supply' via keypad or webpage resets this parameter to the default value for the selected supply voltage/frequency i.e. 230/400/480V						
BASE FREQUENCY	224	50	1 to 1000	Hz	REAL	STOPPED
The base motor frequency on the name plate. Attention: Changing parameter P1006 'Nominal Supply' via keypad or webpage resets this parameter to the default value for the selected supply voltage/frequency i.e. 50/60 Hz						
MOTOR POLES	225	4	2 to 1000		UINT	STOPPED
Motor poles on the nameplate.						
NAMEPLATE SPEED	226	1450	0 to 100000	rpm	REAL	STOPPED
Rated motor speed on the name plate. Attention: Changing parameter P1006 'Nominal Supply' via keypad or webpage resets this parameter to the default value for the selected supply voltage/frequency.						
MOTOR POWER	227	0.75	0 to 3000	kW	REAL	STOPPED
Motor power rating.						
POWER FACTOR	228	0.71	0 to 1		REAL	STOPPED
Motor power factor on the name plate.						
AUTO POLE PAIRS	229	TRUE			BOOL	ALWAYS
TRUE: Automatic Pole Pairs Selection, calculated from nameplate speed, FALSE: user can modify motor poles.						
IM MOTOR NAME	2552	My IM name			STRING	ALWAYS
Name of the induction motor (for user reference)						

MRAS

Overview

These parameters are associated to the internal induction motor speed estimator (MRAS) module.

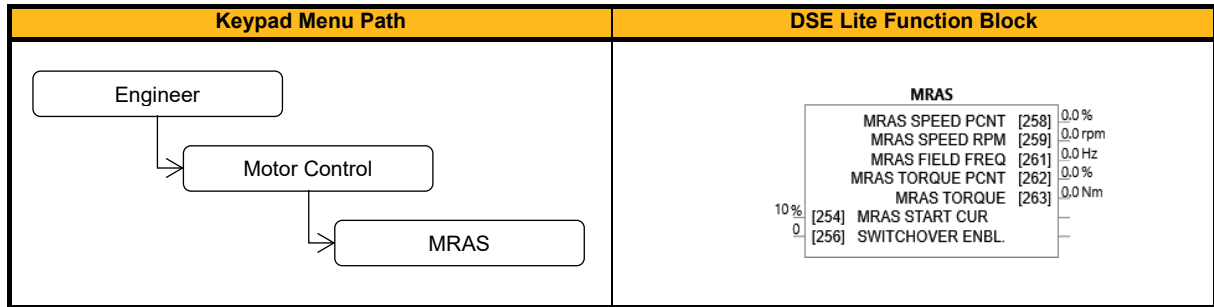

Function Block Inputs

Parameter Name	No.	Default Value	Range	Units	Type	Writable
MRAS START CUR	254	10	0 to 100	%	REAL	ALWAYS
This parameter is used in conjunction with MRAS sensorless vector control. It defines the current level during the sensorless startup procedure (when starting motors). The value needs to be increased if the motor is not starting properly from zero speed (especially for small motors with low chosen acceleration or generally in case of high motor load). Unit is in % of motor rated current.						
SWITCHOVER ENBL.	256	False			BOOL	ALWAYS
Enables the automatic switch over from encoder feedback to estimator in the case of an encoder failure. Switch over if speed difference threshold is 300rpm after 95% of setpoint speed is reached.						

Function Block Outputs

Parameter Name	No.	Default Value	Range	Units	Type	Writable
MRAS SPEED PCNT	258	0.0		%	REAL	NOT
MRAS Speed Percent						
MRAS SPEED RPM	259	0.0		rpm	REAL	NOT
Mechanical rotor speed in RPM calculated by the estimator						
MRAS FIELD FREQ	261	0.0		Hz	REAL	NOT
Field Frequency in electrical Hz, calculated by the estimator for vector rotation.						
MRAS TORQUE PCNT	262	0.0		%	REAL	NOT
Torque calculated by the estimator in percent.						
MRAS TORQUE	263	0.0		Nm	REAL	NOT
Torque calculated by the estimator in Nm.						

Functional Description

The parameter **0256 Switchover Enable** provides the user with the option to automatically, and as seamlessly as possible, continue operating in sensorless mode in case of an encoder failure. The MRAS estimator tracks the speed of the motor even if the drive uses encoder as its primary feedback for control. If the discrepancy between the speed measured by encoder and the estimated speed is greater than 300 RPM it is assumed that the encoder has malfunctioned and the control will automatically be transferred to use estimated speed as its feedback signal. The drive will continue to work in sensorless mode until the next stop cycle. There will be no attempt to 'reconnect' encoder on the fly even if its signal recovers. Upon the move to sensorless operation a warning will be issued that this has taken place.

The switchover will not be performed during an autotune sequence, even if enabled, until the estimator converges to correct speed (typically within first 50-100ms after starting the drive), and until the motor has accelerated to 95% of its initial speed setpoint. The switchover will also not be performed if the setpoint speed is lower than the switchover threshold of 300 RPM.

Multi-Stage Speed

Overview

The Multi-Stage Speed function can call up to 15 stages and is used in conjunction with the Auto Circulate function block. Setpoint sets or stages are selected by the Stage Select Parameter. For each stage a separate speed, acceleration and deceleration can be defined.

Keypad Menu Path	DSE Lite Function Block
<pre> graph TD Engineer[Engineer] --> Application[Application] Application --> MultiStageSpeed[Multi-Stage Speed] </pre>	<p>Multi-Stage Speed</p> <p>SPEED OUTPUT [1900] 0%</p> <p>REVERSE OUTPUT [1901] FALSE</p> <p>ACCEL TIME OP [1902] 0.5</p> <p>DECEL TIME OP [1903] 0.5</p> <p>0 [1834] STAGE SELECT</p> <p>FALSE [1835] STAGE MODE</p> <p>10% [1836] SPEED[0]</p> <p>20% [1836] SPEED[1]</p> <p>30% [1836] SPEED[2]</p> <p>40% [1836] SPEED[3]</p> <p>50% [1836] SPEED[4]</p> <p>60% [1836] SPEED[5]</p> <p>70% [1836] SPEED[6]</p> <p>80% [1836] SPEED[7]</p> <p>10% [1836] SPEED[8]</p> <p>20% [1836] SPEED[9]</p> <p>30% [1836] SPEED[10]</p> <p>40% [1836] SPEED[11]</p> <p>50% [1836] SPEED[12]</p> <p>60% [1836] SPEED[13]</p> <p>70% [1836] SPEED[14]</p> <p>0 [1852] REVERSE[0]</p> <p>0 [1852] REVERSE[1]</p> <p>0 [1852] REVERSE[2]</p> <p>0 [1852] REVERSE[3]</p> <p>0 [1852] REVERSE[4]</p> <p>0 [1852] REVERSE[5]</p> <p>0 [1852] REVERSE[6]</p> <p>0 [1852] REVERSE[7]</p> <p>0 [1852] REVERSE[8]</p> <p>0 [1852] REVERSE[9]</p> <p>0 [1852] REVERSE[10]</p> <p>0 [1852] REVERSE[11]</p> <p>0 [1852] REVERSE[12]</p> <p>0 [1852] REVERSE[13]</p> <p>0 [1852] REVERSE[14]</p> <p>5s [1868] ACCEL TIME[0]</p> <p>5s [1868] ACCEL TIME[1]</p> <p>5s [1868] ACCEL TIME[2]</p> <p>5s [1868] ACCEL TIME[3]</p> <p>5s [1868] ACCEL TIME[4]</p> <p>5s [1868] ACCEL TIME[5]</p> <p>5s [1868] ACCEL TIME[6]</p> <p>5s [1868] ACCEL TIME[7]</p> <p>5s [1868] ACCEL TIME[8]</p> <p>5s [1868] ACCEL TIME[9]</p> <p>5s [1868] ACCEL TIME[10]</p> <p>5s [1868] ACCEL TIME[11]</p> <p>5s [1868] ACCEL TIME[12]</p> <p>5s [1868] ACCEL TIME[13]</p> <p>5s [1868] ACCEL TIME[14]</p> <p>5s [1884] DECEL TIME[0]</p> <p>5s [1884] DECEL TIME[1]</p> <p>5s [1884] DECEL TIME[2]</p> <p>5s [1884] DECEL TIME[3]</p> <p>5s [1884] DECEL TIME[4]</p> <p>5s [1884] DECEL TIME[5]</p> <p>5s [1884] DECEL TIME[6]</p> <p>5s [1884] DECEL TIME[7]</p> <p>5s [1884] DECEL TIME[8]</p> <p>5s [1884] DECEL TIME[9]</p> <p>5s [1884] DECEL TIME[10]</p> <p>5s [1884] DECEL TIME[11]</p> <p>5s [1884] DECEL TIME[12]</p> <p>5s [1884] DECEL TIME[13]</p> <p>5s [1884] DECEL TIME[14]</p>

Function Block Inputs

Parameter Name	No.	Default Value	Range	Units	Type	Writable
STAGE SELECT	1834	0	0 to 15		USINT	ALWAYS
Selects the input group to pass to the outputs (Stage 0..14)						
STAGE MODE	1835	FALSE			BOOL	ALWAYS
When Stage Mode is FALSE, the first stage is selected by Stage Select of 0. When Stage Mode is TRUE, the first stage is selected by Stage Select of 1.						
SPEED[0]	1837	10	0.0 to 300.0	%	REAL	ALWAYS
Speed inputs.						
SPEED[1]	1838	20	0.0 to 300.0	%	REAL	ALWAYS
Speed inputs.						
SPEED[...]
Speed inputs.						
SPEED[7]	1844	80	0.0 to 300.0	%	REAL	ALWAYS
Speed inputs.						
SPEED[8]	1845	10	0.0 to 300.0	%	REAL	ALWAYS
Speed inputs.						
SPEED[9]	1846	20	0.0 to 300.0	%	REAL	ALWAYS
Speed inputs.						
SPEED[...]
Speed inputs.						
SPEED[14]	1851	70	0.0 to 300.0	%	REAL	ALWAYS
Speed inputs.						
REVERSE[0]	1853	0			BOOL	ALWAYS
Reverse selection inputs.						
REVERSE[1]	1854	0			BOOL	ALWAYS
Reverse selection inputs.						
REVERSE[...]	...					
Reverse selection inputs.						
REVERSE[14]	1867	0			BOOL	ALWAYS
Reverse selection inputs.						
ACCEL TIME[0]	1869	5	0.0 to 3000.0	s	REAL	ALWAYS
Acceleration Time inputs.						
ACCEL TIME[1]	1870	5	0.0 to 3000.0	s	REAL	ALWAYS
Acceleration Time inputs.						
ACCEL TIME[...]	...					
Acceleration Time inputs.						
ACCEL TIME[14]	1883	5	0.0 to 3000.0	s	REAL	ALWAYS
Acceleration Time inputs.						
DECEL TIME[0]	1885	5	0.0 to 3000.0	s	REAL	ALWAYS
Deceleration Time inputs.						
DECEL TIME[1]	1886	5	0.0 to 3000.0	s	REAL	ALWAYS
Deceleration Time inputs.						
DECEL TIME[...]	...					
Deceleration Time inputs.						
DECEL TIME[14]	1899	5	0.0 to 3000.0	s	REAL	ALWAYS
Deceleration Time inputs.						

Function Block Outputs

Parameter Name	No.	Default Value	Range	Units	Type	Writable
SPEED OUTPUT	1900	0		%	REAL	NOT
Speed output of the stage currently selected						
REVERSE OUTPUT	1901	FALSE			BOOL	NOT
Direction of the stage currently selected						
ACCEL TIME OP	1902	0		s	REAL	NOT
Acceleration Time of the selected stage (actually used).						
DECEL TIME OP	1903	0		s	REAL	NOT
Deceleration Time of the stage currently selected						

Functional Description

The Multi-Stage Speed function is intended for use with fan or pump applications to 'preset' values of speed, direction and ramp time for up to 15 'stages'. Alternatively, it may be used as a 'preset' for other applications.

The **Stage Select** input chooses one of 15 pre-defined stages. The outputs of the block are intended for connection to the Reference and Ramp blocks as shown below but may be used within a custom application for any purpose.

For example, An input at Stage Select of 1 results in **Speed[1]**, **Accel Time[1]**, **Decel Time[1]** and **Reverse[1]** appearing out the outputs of the multi-stage speed block.

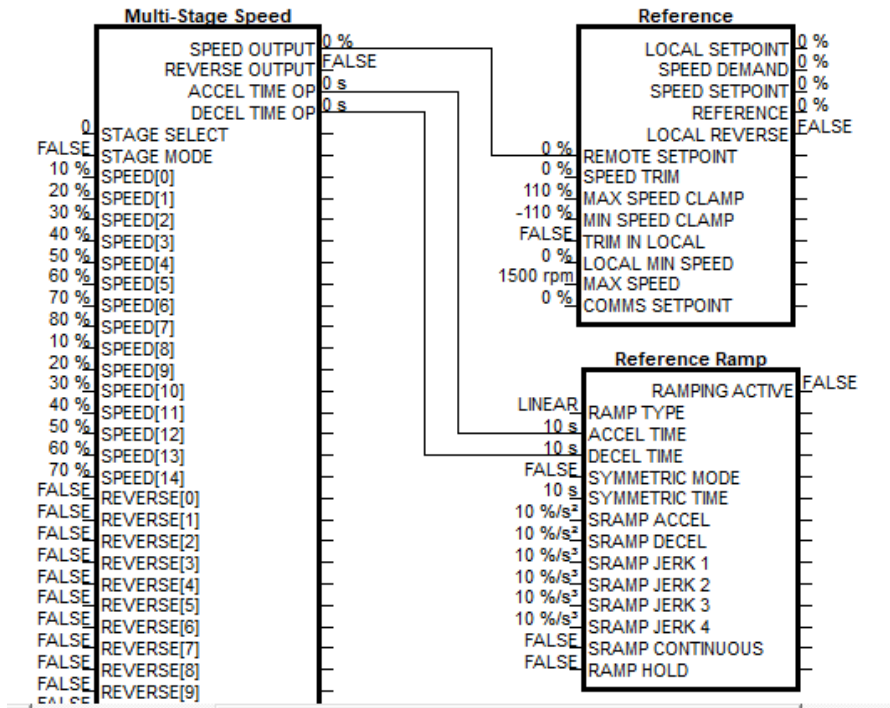

Multiplexer 1 & Multiplexer 2

Overview

Each block collects together 16 Boolean input values into a single word.

For example, one may be used to set and clear individual bits within a word such as the **AR Trip Mask** for the Auto Restart function block.

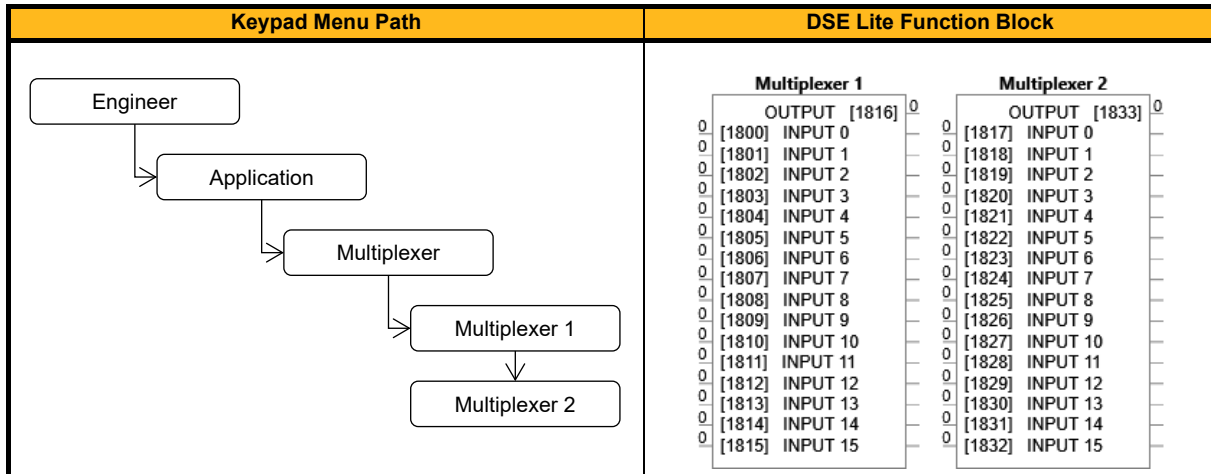

Function Block Inputs

Parameter Name	No.	Default Value	Range	Units	Type	Writable
INPUT 0						
Multiplexer 1	1800	0			BIT	ALWAYS
Multiplexer 2	1817	0			BIT	ALWAYS
Input Bit 0.						
INPUT 1						
Multiplexer 1	1801	0			BIT	ALWAYS
Multiplexer 2	1818	0			BIT	ALWAYS
Input Bit 1.						
INPUT 2						
Multiplexer 1	...					
Multiplexer 2	...					
Input Bit 2.						
INPUT 15						
Multiplexer 1	1815	0			BIT	ALWAYS
Multiplexer 2	1832	0			BIT	ALWAYS
Input Bit 15.						

Function Block Outputs

Parameter Name	No.	Default Value	Range	Units	Type	Writable
OUTPUT						
Multiplexer 1	1816	0			WORD	NOT
Multiplexer 2	1833	0			WORD	NOT
Output word (containing Input 1..15).						

Pattern Gen

Overview

The pattern generator function block allows you to configure the Inverter PWM (Pulse Width Modulator) operation.

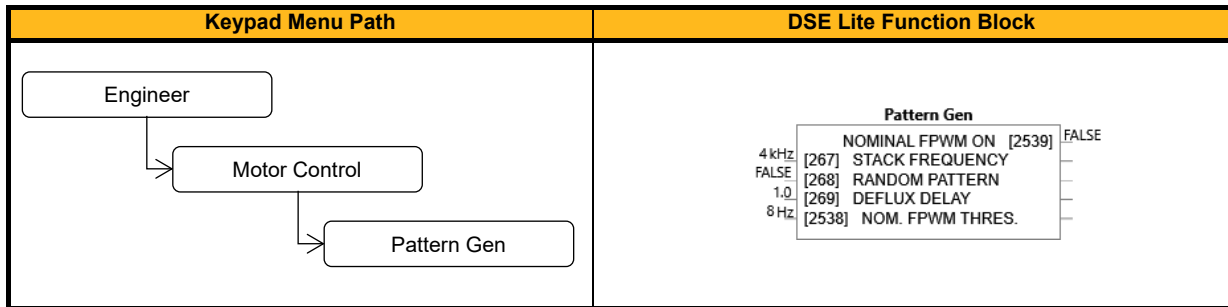

Function Block Inputs

Parameter Name	No.	Default Value	Range	Units	Type	Writable
STACK FREQUENCY	267	4	1 to 16	kHz	REAL	ALWAYS
This parameter selects the PWM switching frequency of the power stack. Please note that a setting higher than the nominal (default) stack PWM frequency is only used if the required electrical output frequency is greater than P2538 'Nom. fPWM Thres.' in Hz. This ensures full starting torque by using the nominal frequency at low speeds. The stack frequency value is directly used as PWM frequency when P0268 'Random Pattern' = FALSE, or it is used as the mean switching frequency value when P0268 'Random Pattern' = TRUE. The higher the switching frequency, the lower the level of motor audible noise and closed loop current and speed control update delay. However, this is only achieved at the expense of increased drive losses, reduced stack current rating and increased CPU calculation time demand. Default (and nominal) value and maximum possible value is stack dependent. PWM switching frequency limit is 10KHz for fixed pattern and 8KHz for randomized PWM switching.						
RANDOM PATTERN	268	FALSE			BOOL	ALWAYS
This parameter selects between a random pattern (less audible motor noise) or the more conventional fixed carrier PWM strategy. When TRUE, random pattern is enabled, P267 'Stack Frequency' then defines the mean switching frequency.						
DEFLUX DELAY	269	1.0	0 to 60		TIME	STOPPED
Sets the minimum allowed delay between disabling and then re-enabling PWM production (i.e. stopping and starting the drive).						
NOM. FPWM THRES.	2538	8	0 to 550	Hz	REAL	ALWAYS
This parameter selects the electrical low output frequency threshold in unit Hz for forcing nominal PWM switching frequency. If the Stack Frequency (P0267) is set higher than the Nominal stack PWM frequency this feature becomes active. In this case the nominal stack PWM frequency is used if the electrical output frequency is lower than the threshold and full stack current is available. If the electrical output frequency is greater than the threshold, the (higher) Stack PWM frequency (P0267) is used and current output is derated. A hysteresis of -10% is used for the switchover from Stack Frequency back to stack nominal PWM frequency. Setting to 0Hz deactivates this feature, and Stack frequency (P0267) is always used. The feature provides better startup in combination with quieter continuous speed operation of induction motors in VHz mode. It is not recommended for use in Vector mode.						

Function Block Outputs

Parameter Name	No.	Default Value	Range	Units	Type	Writable
NOMINAL FPMW ON	2539	FALSE			BOOL	NOT
This parameter shows whether the 'force nominal stack frequency at low el. output frequency' feature (controllable by parameter P2538) is active or not. TRUE= Drive runs with forced (lower than user demanded) nominal stack PWM frequency, FALSE= (Higher than default) user stack PWM frequency is active.						

Functional Description

It is possible to select the PWM carrier frequency. This is the main switching frequency of the power output stage of the Frequency Inverter. A high setting of carrier frequency (e.g. 6kHz) reduces audible motor noise but only at the expense of higher Inverter losses and smooth motor rotation at low output frequencies. A low setting of carrier frequency (e.g. 3kHz), reduces Inverter losses but increases audible motor noise.

The Inverter also provides a quiet pattern PWM strategy in order to reduce audible motor noise. It is possible to select between the quiet 'random' pattern or the more conventional fixed carrier frequency method. With the quiet pattern strategy selected (random pattern enabled), audible motor noise is reduced to a dull hiss.

PID1 & PID2

Overview

This function allows the inverter to be used in applications requiring a trim to the reference, depending on feedback from an external measurement device. Typically, this will be used for process control, i.e. pressure or flow.

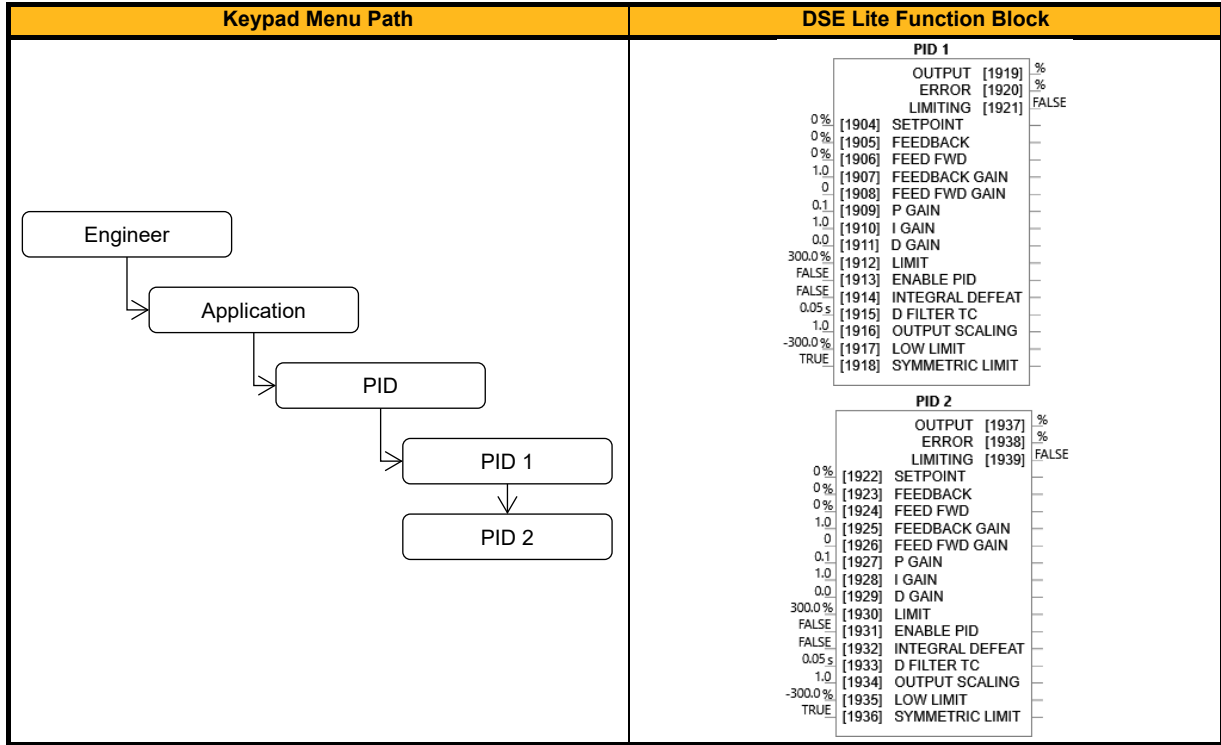

Function Block Inputs

Parameter Name	No.	Default Value	Range	Units	Type	Writable
SETPOINT						
PID 1	1904	0	-300.0 to 300.0	%	REAL	ALWAYS
PID 2	1922	0	-300.0 to 300.0	%	REAL	ALWAYS
Setpoint Input of the PID block.						
FEEDBACK						
PID 1	1905	0	-300.0 to 300.0	%	REAL	ALWAYS
PID 2	1923	0	-300.0 to 300.0	%	REAL	ALWAYS
Feedback input of the PID block.						
FEED FWD						
PID 1	1906	0	-300.0 to 300.0	%	REAL	ALWAYS
PID 2	1924	0	-300.0 to 300.0	%	REAL	ALWAYS
Feed Forward input of the PID block.						
FEEDBACK GAIN						
PID 1	1907	1.0	-10.0 to 10.0		REAL	ALWAYS
PID 2	1925	1.0	-10.0 to 10.0		REAL	ALWAYS
Gain of the Feedback signal (default: 1.0).						
FEED FWD GAIN						
PID 1	1908	0	-10.0 to 10.0		REAL	ALWAYS
PID 2	1926	0	-10.0 to 10.0		REAL	ALWAYS
Gain of the Feed Forward signal (default: 0.0).						
P GAIN						
PID 1	1909	0.1	0.0 to 100.0		REAL	ALWAYS
PID 2	1927	0.1	0.0 to 100.0		REAL	ALWAYS
Proportional gain of the PID controller. With a P gain of zero, the PID output would be zero.						

I GAIN							
PID 1	1910	1.0	0.0 to 100.0			REAL	ALWAYS
PID 2	1928	1.0	0.0 to 100.0			REAL	ALWAYS
Integral gain of the PID controller.							
D GAIN							
PID 1	1911	0.0	0.0 to 100.0			REAL	ALWAYS
PID 2	1929	0.0	0.0 to 100.0			REAL	ALWAYS
Differential gain of the PID controller.							
LIMIT							
PID 1	1912	300.0	0.0 to 300.0		%	REAL	ALWAYS
PID 2	1930	300.0	0.0 to 300.0		%	REAL	ALWAYS
This parameter determines the maximum positive excursion (Limit) of the PID output.							
ENABLE PID							
PID 1	1913	FALSE				BOOL	ALWAYS
PID 2	1931	FALSE				BOOL	ALWAYS
This parameter globally resets the PID output and integral term when FALSE. Enable must be TRUE for the PID to operate.							
INTEGRAL DEFEAT							
PID 1	1914	FALSE				BOOL	ALWAYS
PID 2	1932	FALSE				BOOL	ALWAYS
This parameter resets the PID integral term when FALSE.							
D FILTER TC							
PID 1	1915	0.05	0.05 to 5.0		s	REAL	ALWAYS
PID 2	1933	0.05	0.05 to 5.0		s	REAL	ALWAYS
Derivate time constant of the PID controller.							
OUTPUT SCALING							
PID 1	1916	1.0	-3.0 to 3.0			REAL	ALWAYS
PID 2	1934	1.0	-3.0 to 3.0			REAL	ALWAYS
This parameter represents an overall scaling factor which is applied after the PID positive and negative limit clamps.							
LOW LIMIT							
PID 1	1917	-300.0	-300.0 to 0.0		%	REAL	ALWAYS
PID 2	1935	-300.0	-300.0 to 0.0		%	REAL	ALWAYS
This parameter determines the maximum negative excursion (Limit) of the PID output.							
SYMMETRIC LIMIT							
PID 1	1918	TRUE				BOOL	ALWAYS
PID 2	1936	TRUE				BOOL	ALWAYS
If TRUE, the negative limit of the PID output is set to -(maximum positive limit).							

Function Block Outputs

Parameter Name	No.	Default Value	Range	Units	Type	Writable
OUTPUT						
PID 1	1919		-300.0 to 300.0	%	REAL	NOT
PID 2	1937		-300.0 to 300.0	%	REAL	NOT
Output of the PID function.						
ERROR						
PID 1	1920		-300.0 to 300.0	%	REAL	NOT
PID 2	1938		-300.0 to 300.0	%	REAL	NOT
The result of SETPOINT - FEEDBACK (clamped to +/-100%).						
LIMITING						
PID 1	1921	FALSE			BOOL	NOT
PID 2	1939	FALSE			BOOL	NOT
Output signal of the PID controller is clamped (either by positive or by negative limit).						

Functional Description

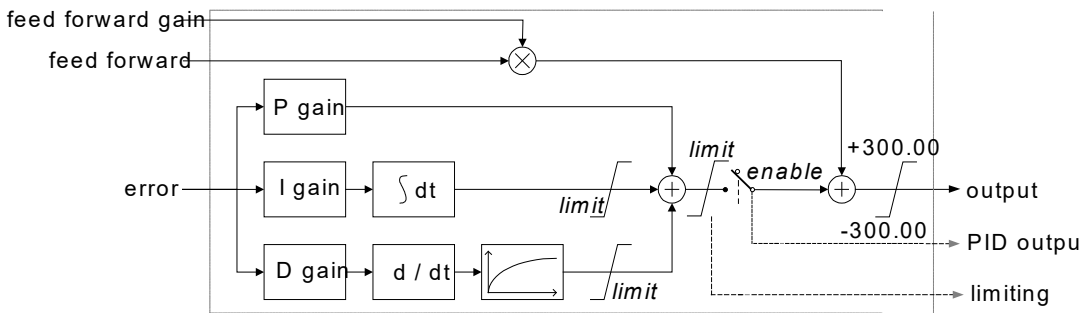
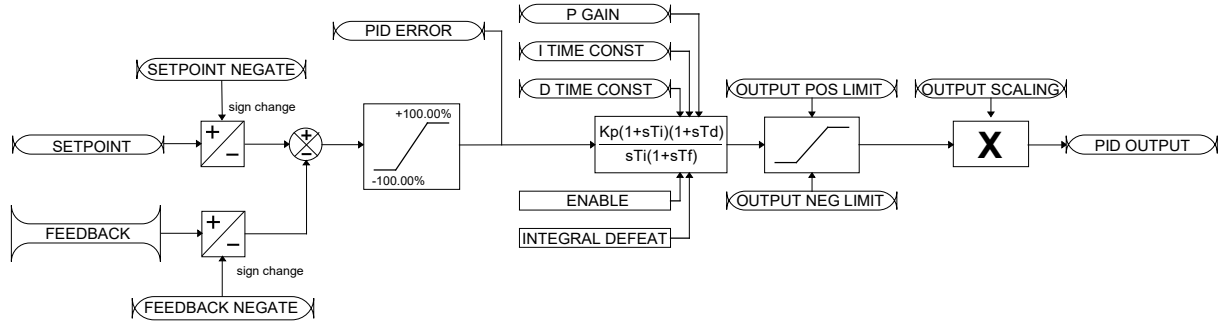

- Functions as P, PI, PD and PID with filtering.
- Single symmetric limit on output.

PID Stage

The formula which describes the action of the PID in the 'S' domain is as follows:

$$PID = K_p \frac{K_i}{S} + K_d \frac{S}{1 + S_F T}$$

where: K_p is the proportional gain
 K_i is the integral gain
 T_F is the filter time constant
 K_d is the derivative gain

For an application that requires closed loop control, the error term may be derived from the setpoint and feedback using a value function block. This error term is then used by the PID. The output of the PID may be used to trim the demand setpoint via the parameter **0452 Speed Trim** in the Reference function block.

PMAC Motor Adv

Overview

Only available if PMAC Motor selected in **0030 Motor Type**.

The PMAC Motor Advanced allows to move the current setpoint of a PMAC Motor to the D and Q axis, adding a predictive phase shift to the current. The phase shift is proportional to the current level.

By default, values are set to Zero. Only change values if data is given by the motor manufacturer.

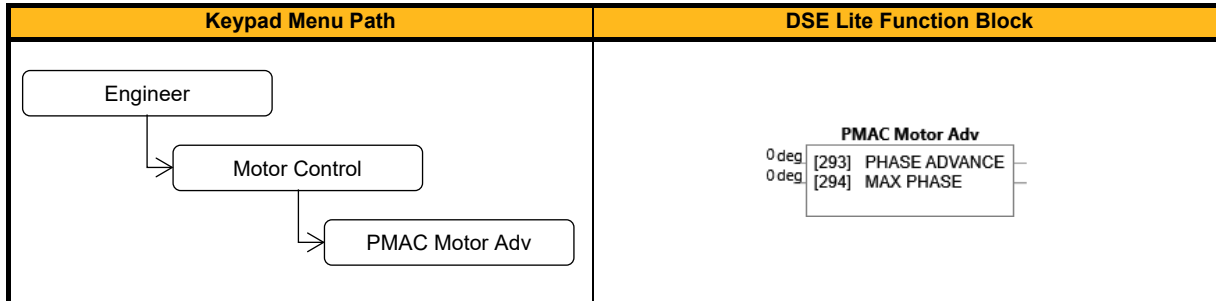

Function Block Inputs

Parameter Name	No.	Default Value	Range	Units	Type	Writable
PHASE ADVANCE	293	0	0 to 90	deg	REAL	STOPPED
Phase advance in electrical degrees on current at rated current level, proportional to the current level.						
MAX PHASE	294	0	0 to 90	deg	REAL	STOPPED
Max phase advance applied to the current.						

Functional Description

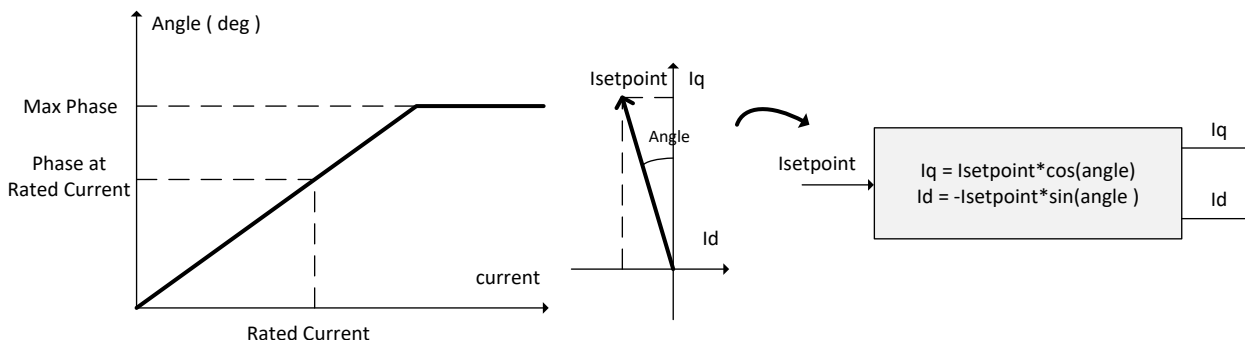

PMAC Motor Data

Overview

Only required if PMAC Motor selected in **0030 Motor Type**.

The PMAC Motor Data contains the parameters needed to run and control a PMAC motor. A PMAC motor is a Permanent Magnet AC Motor with sinusoidal back EMF.

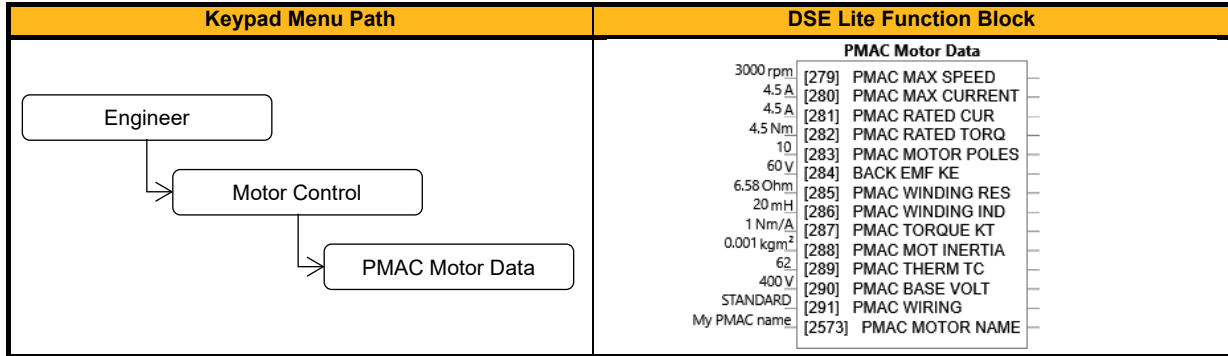

Function Block Inputs

Parameter Name	No.	Default Value	Range	Units	Type	Writable
PMAC MAX SPEED	279	3000	1.0 to 100000.0	rpm	REAL	ALWAYS
Set the maximum motor speed (in rpm).						
PMAC MAX CURRENT	280	4.5	0.05 to 5000	A	REAL	ALWAYS
Set the maximum motor current (in Amps rms).						
PMAC RATED CUR	281	4.5	0.05 to 5000	A	REAL	ALWAYS
Set the rated motor current (in Amps rms). Refer to Motor Current Percent in the Feedbacks function. A value of 100% = PMAC rated Current.						
PMAC RATED TORQ	282	4.5	0.01 to 30000.0	Nm	REAL	ALWAYS
Set the rated motor torque. Refer to Actual Torque in the Feedbacks function. A value of 100% = PMAC Rated Torque.						
PMAC MOTOR POLES	283	10	2 to 400		UINT	ALWAYS
Set the number of motor poles, e.g. for a 4 pole motor enter "4".						
BACK EMF KE	284	60	0.1 to 30000	V	REAL	ALWAYS
Set the motor's Back EMF line to line, rms value (Ke, phase to phase Volts rms per 1000 rpm). Notes: Value is also estimated during autotune sequence. Value can also be estimated out of motor torque constant kt: $ke = \text{torque_constant_Nm/Arms} * 60.45 = \text{rated_torque_Nm/rated_current_rms} * 60.45$.						
PMAC WINDING RES	285	6.58	0.001 to 500.0	Ohm	REAL	ALWAYS
Set the motor's resistance, line to line at 25 °C. This parameter is used within the current loop.						
PMAC WINDING IND	286	20	0.01 to 1000.0	mH	REAL	ALWAYS
Set the motor's inductance line to line at maximum current. This parameter is used within the current loop and is related to the overall proportional gain.						
PMAC TORQUE KT	287	1	0.01 to 10000.0	Nm/A	REAL	ALWAYS
Torque constant (Kt, Nm/A rms). This parameter is used to compute the current demand given a torque demand : Current demand = Torque demand / KT. Notes: Value is also estimated during autotune sequence. Value can be estimated by calculating $\text{rated_torque_Nm/rated_current_rms}$. Back emf ke (Vrms phase/phase per 1000rpm) can be calculated out of KT: $Ke = KT/60.45$						
PMAC MOT INERTIA	288	0.001	0.0001 to 100.0	kgm ²	REAL	ALWAYS
Rotor inertia of the motor (without load inertia). Note: The load inertia shall be entered as a ratio factor via Speed Loop P333 'Ratio JLoad/JMot'. $P333 = JLoad / JMotor$ or $P333 = (Joverall/JMotor) - 1$						
PMAC THERM TC	289	62	1 to 10000		TIME	ALWAYS
Copper Thermal Time constant(s). If not known, set to 300s. This parameter is used for the motor thermal protection : I2T motor function. It represents the time needed to reach 63% of the rated load of the motor if 100% of the rated current is applied to the motor (typical time constant of a first order low pass filter).						
PMAC BASE VOLT	290	400	1 to 1000	V	REAL	ALWAYS
The rated motor voltage on the name plate.						
PMAC WIRING	291	0: Standard	0: Standard 1: Reverse		ENUM	ALWAYS
Wiring direction of the motor phase (U-V-W or U-W-V).						
PMAC MOTOR NAME	2573	My PMAC name			STRING	ALWAYS
Name of the PMAC motor (for user reference)						

PMAC SVC

Overview

Only available if PMAC MOTOR selected in **0030 Motor Type**.

Parameters related to the SVC Control mode of a PMAC Motor

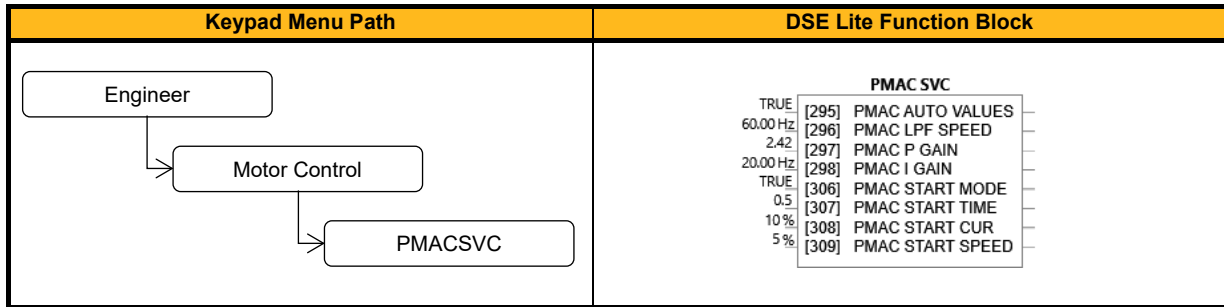

Function Block Inputs

Parameter Name	No.	Default Value	Range	Units	Type	Writable
PMAC AUTO VALUES	295	TRUE			BOOL	ALWAYS
Selection of PI controller values for PMAC motors. TRUE: use pre-calculated values, FALSE: use user settings.						
PMAC LPF SPEED	296	60.00	0 to 10000	Hz	REAL	ALWAYS
Set the Low Pass Filter frequency of the estimated speed.						
PMAC P GAIN	297	2.42	0 to 10000		REAL	ALWAYS
Set the Proportional gain of the PI corrector used for extracting speed and position.						
PMAC I GAIN	298	20.00	0 to 10000	Hz	REAL	ALWAYS
Set the Integral frequency of the PI corrector used for extracting speed and position.						
PMAC START MODE	306	TRUE			BOOL	ALWAYS
This parameter is used to enable/disable a specific startup procedure when the motor/drive is switched ON (starting rotation). This is mainly used where applications need to start the motor with a high inertia and/or friction load and the standard start is ineffective						
PMAC START TIME	307	0.5	0 to 1000		TIME	ALWAYS
This parameter is used in conjunction with PMAC Start Mode. It selects the duration of Step 1 in the startup procedure used for starting motors with a high inertia and/or friction load.						
PMAC START CUR	308	10	0 to 600	%	REAL	ALWAYS
This parameter is used in conjunction with PMAC Start Mode. It selects the current level during the startup procedure used for starting motors with a high inertia and/or friction load.						
PMAC START SPEED	309	5	0 to 200	%	REAL	ALWAYS
This parameter is used in conjunction with PMAC Start Mode. It selects the speed setpoint at which the speed control is switched from an open loop mode (V/Hz Control) to a closed loop mode (using speed observer for PMAC motors) during the startup procedure used for starting motors with a high inertia and/or friction load.						

Functional Description

Using **0306 Start Mode** (=TRUE), the following procedure is applied each time the motor is switched on and before closing the speed loop, based on the external speed setpoint.

The drive must be used in speed loop mode (**0347 Torq Dmd Isolate** = FALSE).

When the drive is switched ON, the system is placed in open loop control.

Step 1:

For a time equal to the **0307 PMAC Start Time** parameter, the current is ramped to the **0308 PMAC Start Cur** value. The sign is dependent upon the speed loop setpoint. A normal value is between 0.5 to 1s.

Step 2:

Once Step 1 is complete, the position is ramped in such a way as to follow the speed setpoint generated, based on the configuration (ramp, etc...), until the **0309 PMAC Start Speed** value is reached. The speed loop is then closed. The ramp value must be kept low to ensure the motor follows the speed setpoint.

For a positive speed setpoint when the drive is switched ON :

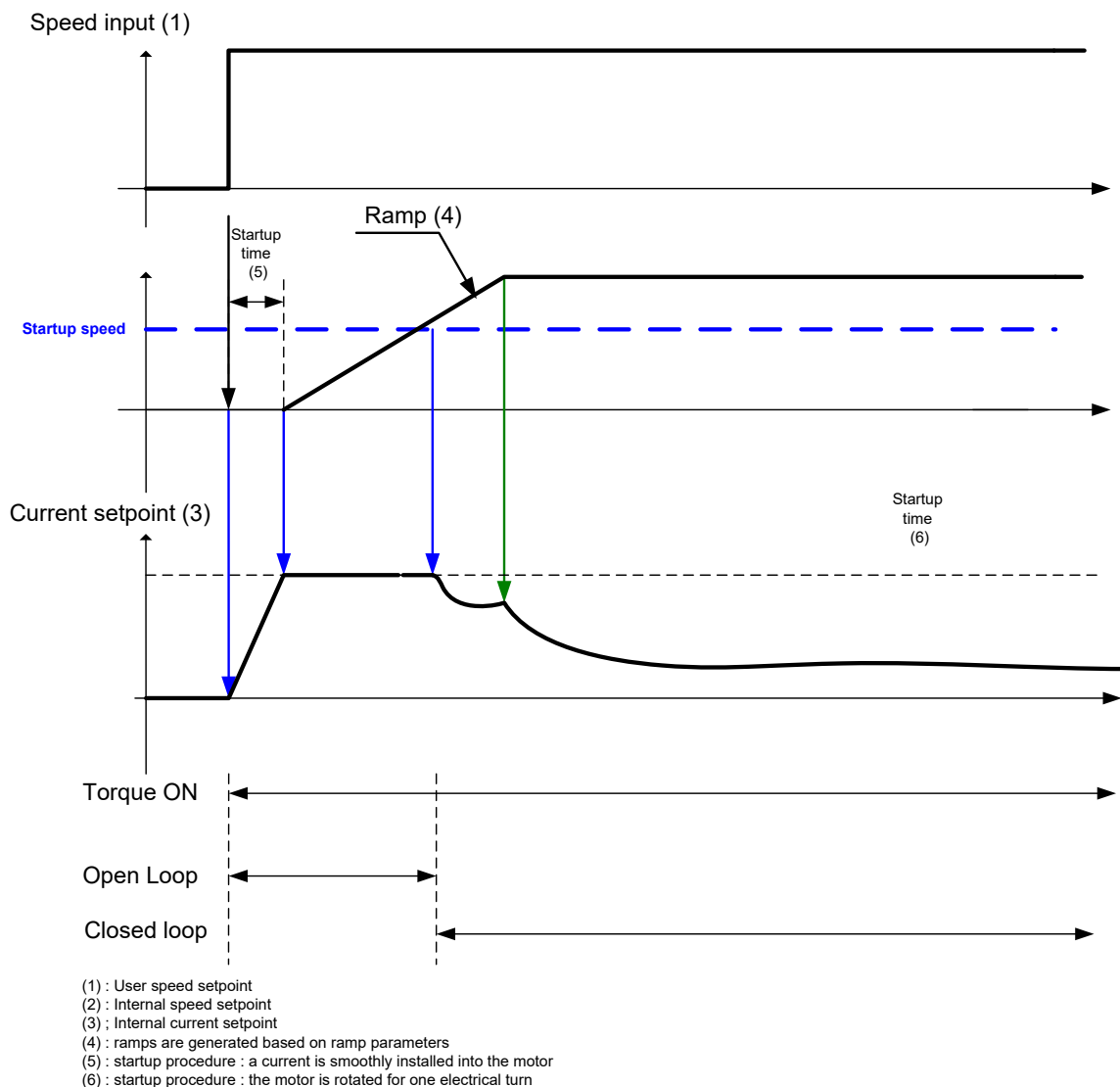

For a negative speed setpoint when the drive is switched ON :

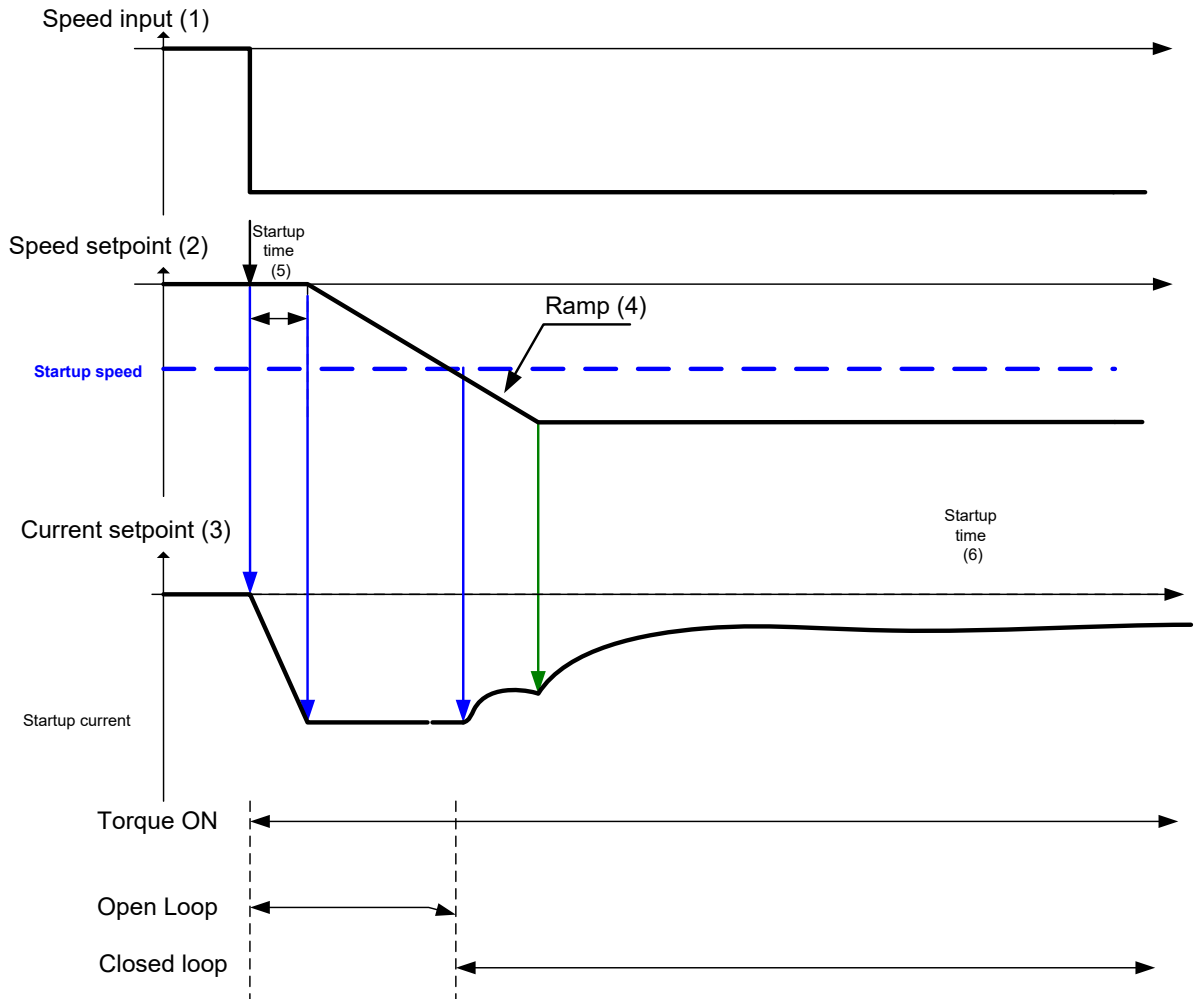

- (1) : User speed setpoint
- (2) : Internal speed setpoint
- (3) : Internal current setpoint
- (4) : ramps are generated based on ramp parameters
- (5) : startup procedure : a current is smoothly installed into the motor
- (6) : startup procedure : the motor is rotated for one electrical turn

Depending on **0309 PMAC Start Speed** the speed setpoint is determined as shown below.

Up and Down Motion - Positive speed

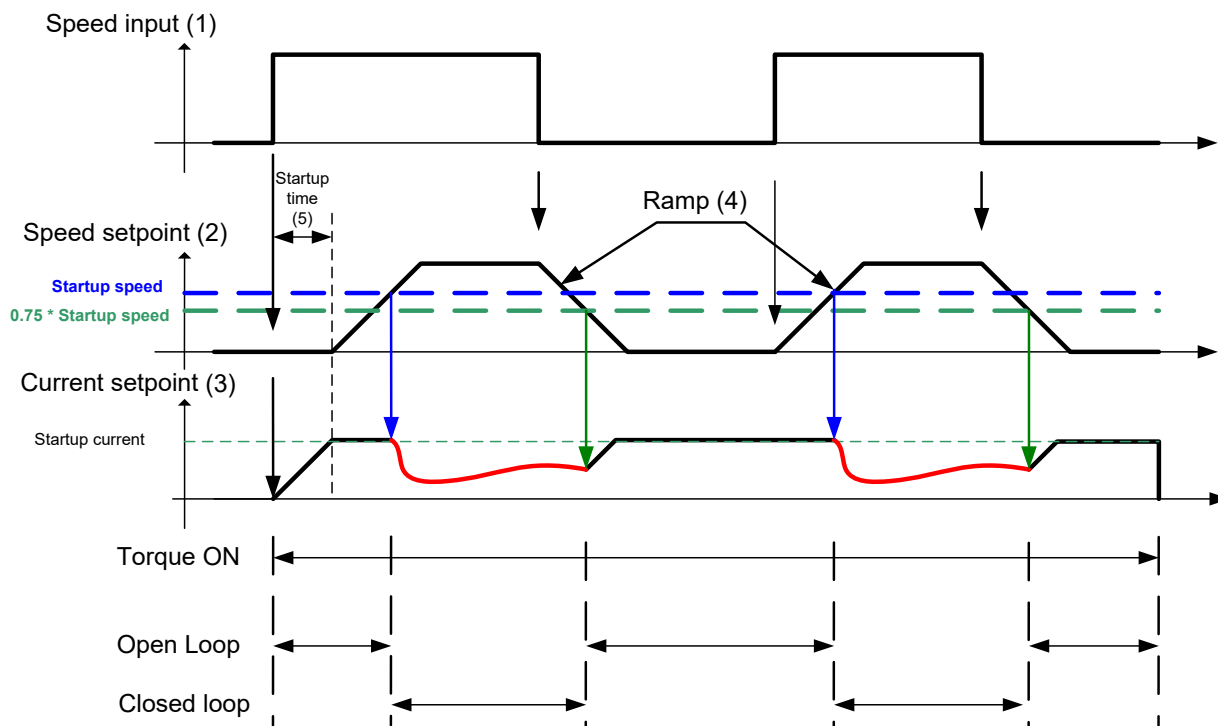

- (1) : User speed setpoint
- (2) : Internal speed setpoint
- (3) : Internal current setpoint
- (4) : ramps are generated based on ramp parameters
- (5) : startup procedure : a current is smoothly installed into the motor

Negative Speed

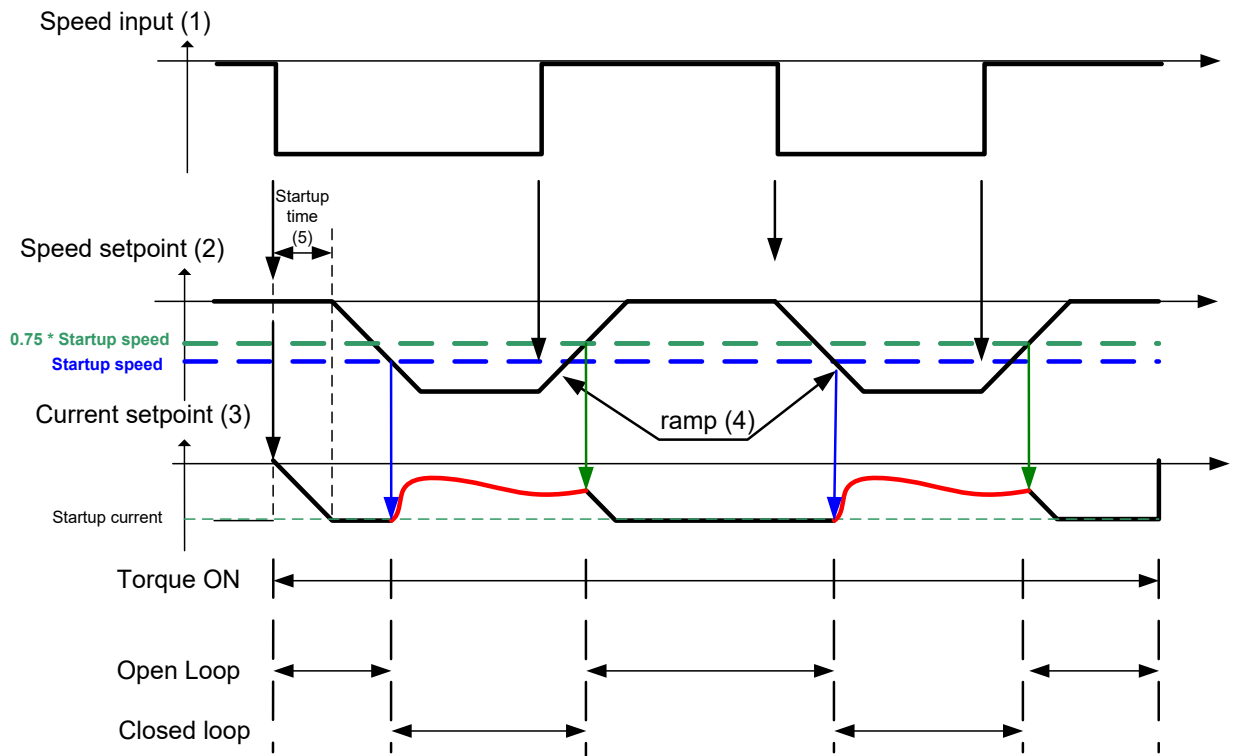

- (1) : User speed setpoint
- (2) : Internal speed setpoint
- (3) ; Internal current setpoint
- (4) : ramps are generated based on ramp parameters
- (5) : startup procedure : a current is smoothly installed into the motor

Crossing zero speed

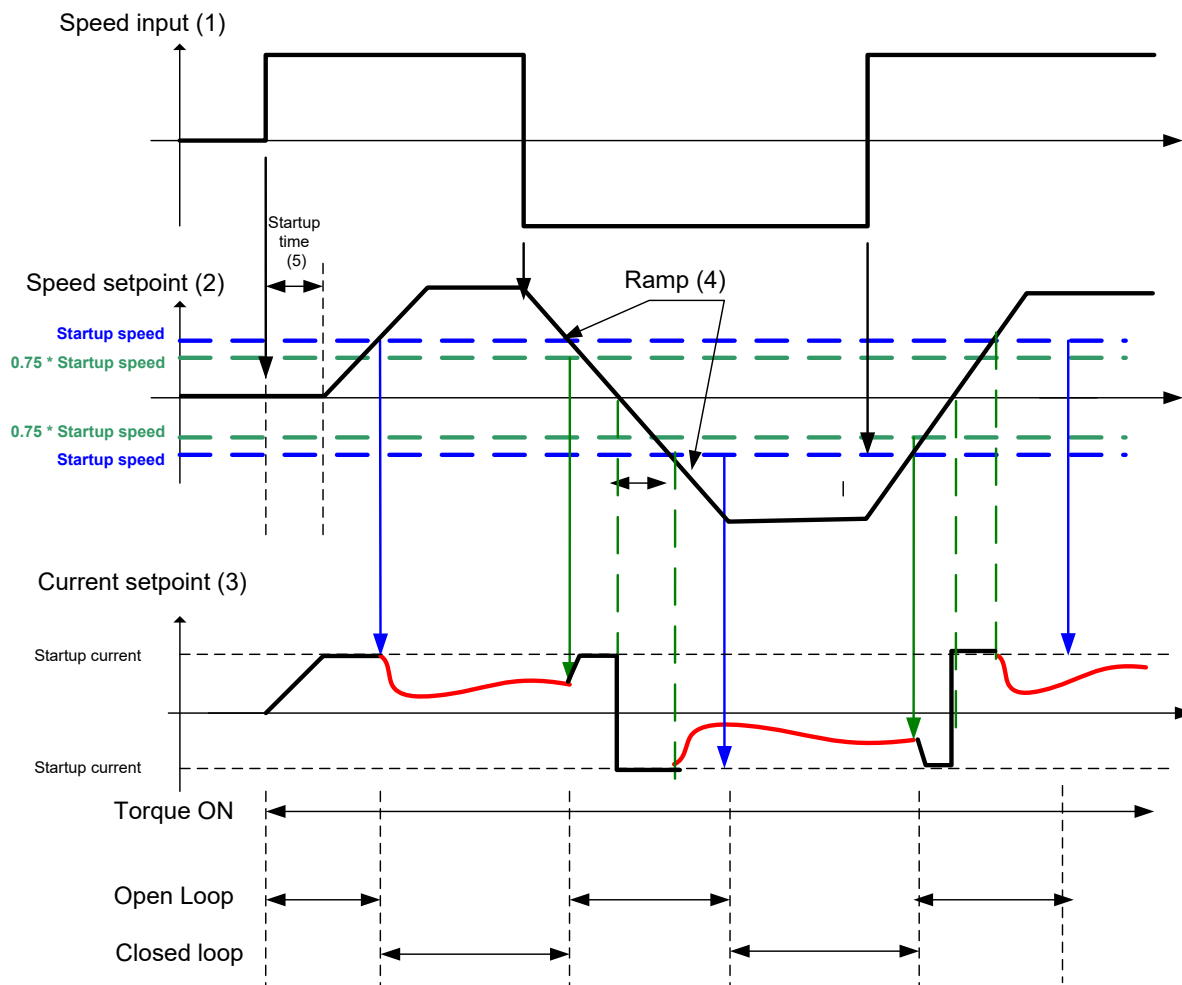

- (1) : User speed setpoint
- (2) : Internal speed setpoint
- (3) ; Internal current setpoint
- (4) : ramps are generated based on ramp parameters
- (5) : startup procedure : a current is smoothly installed into the motor
- (6) : zero crossing for the speed input : the current must be inverted into the motor

Power Loss

Overview

The Power Loss block controls the behavior of the drive during a power outage.

When enabled, the drive attempts to keep the dc link high by regeneratively recovering the kinetic energy in the motor load in the event of a main power supply loss.

This is achieved by ramping the speed setpoint to zero during the power outage. If during the outage the supply returns, the speed setpoint is automatically ramped back to the speed setpoint.

When disabled, the drive will trip on UNDERVOLTS if the mains supply is removed.

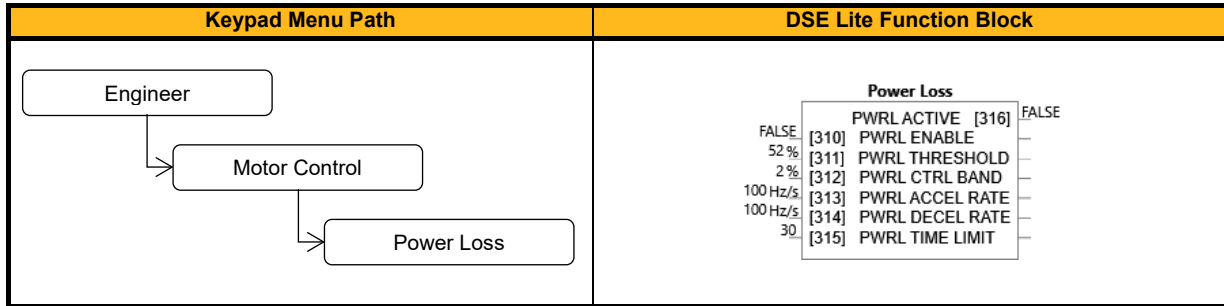

Function Block Inputs

Parameter Name	No.	Default Value	Range	Units	Type	Writable
PWRL ENABLE	310	FALSE			BOOL	STOPPED
Allow the drive to keep the dc link high by regeneratively recovering the kinetic energy in the motor load in the event of mains supply loss. If possible, set the drive to a vector control mode before using this function. 'Phase fail' trip is disabled while this function is active. The DC Link Volts Limit P0069 should be enabled to avoid overvoltage if a brake resistor is not fitted.						
PWRL THRESHOLD	311	55	50 to 68	%	REAL	STOPPED
Given in % of the max. overvoltage level at which the Power Loss Ride Through is triggered. 100% would equal 480V for 230VAC drives and 840V for 480VAC drives. Recommended values assuming -15% allowed mains tolerance: 380V AC: 54%, 400V AC: 57%, 480V AC: 68% (chose the lowest assumed / allowed values for your systems AC mains specification). Note: For induction motors in V/Hz mode the threshold should be set to the max possible value - otherwise the functionality might not work as desired.						
PWRL CTRL BAND	312	10	0 to 20	%	REAL	STOPPED
Sets the % above the Pwrl Threshold at which the setpoint ramp down is stopped. 100% would equal 480V for 230VAC drives and 840V for 480VAC drives.						
PWRL ACCEL RATE	313	100	1 to 500	Hz/s	REAL	STOPPED
Rate at which the speed setpoint is ramped back to the speed demand						
PWRL DECEL RATE	314	100	1 to 500	Hz/s	REAL	STOPPED
Rate at which the speed setpoint is ramped to zero. The value is system dependent. Too high a value could lead to overvoltage fault, too low to undervoltage trip. Note: For induction motors in V/Hz the system might be very sensitive to the chosen value (too low = undervoltage trip, too high = stack over I trip) and for larger motors/drives the default may need to be reduced						
PWRL TIME LIMIT	315	30	0 to 300		TIME	STOPPED
Maximum allowed time for the Power Loss Ride Through sequence. If exceeded a trip is generated.						

Function Block Outputs

Parameter Name	No.	Default Value	Range	Units	Type	Writable
PWRL ACTIVE	316	FALSE			BOOL	NOT
TRUE while the Power Loss Ride Through is active.						

Functional Description

When **0310 Pwrl Enable** is set to TRUE, the block controls the behavior of the drive during a power outage.

This is achieved by ramping the speed setpoint to zero (**0313 Pwrl Decel Rate**).

The dc link fall detection is triggered by **0311 Pwrl Threshold**. **0312 Pwrl Ctrl Band** determines the band of dc link (between **0311 Pwrl Threshold** and **0311 Pwrl Threshold + 0312 Pwrl Ctrl Band**) while the speed setpoint is ramped down to zero using **0314 Pwrl Decel Rate** to try recovering the kinetic energy. If during the outage the supply returns, the speed is automatically ramped back (**0313 Pwrl Accel Rate**) to the speed setpoint.

The drive assumes AC power has returned if the dc link remains higher than (**0311 Pwrl Threshold + 0312 Pwrl Ctrl Band**) for more than 500ms. During this time, the speed setpoint is held.

0315 Pwrl Time Limit determines the maximum time of the Power Loss Ride Through sequence. If this time is exceeded, the drive will trip on POWER LOSS STOP.

During the Power Loss Ride Through sequence, **0316 Pwrl Active** becomes TRUE.

When **0310 Pwrl Enable** is set to FALSE, the drive will trip on UNDERVOLTS if the main supply is removed.

This feature is run at a rate of 1 milli-second.

IMPORTANT: If *DC Link Volts Limit* feature enabled, **0313 Pwrl Accel Rate** and **0313 Pwrl Decel Rate** applied to the speed setpoint are limited by **0466 Acceleration Time** and **0467 Deceleration Time** of the Ramp.

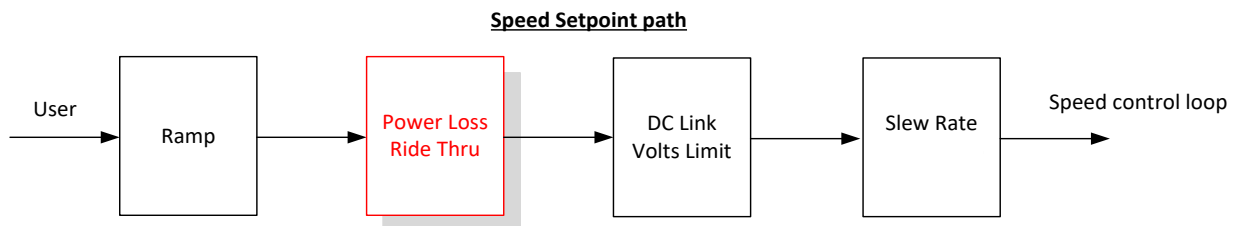

Preset 1, Preset 2, Preset 3, Preset 4, Preset 5, Preset 6, Preset 7 & Preset 8

Overview

The **Preset** functions select 1 of 8 values to be used as a reference for other function blocks. A second output is provided to allow the block to be used as two banks of four inputs.

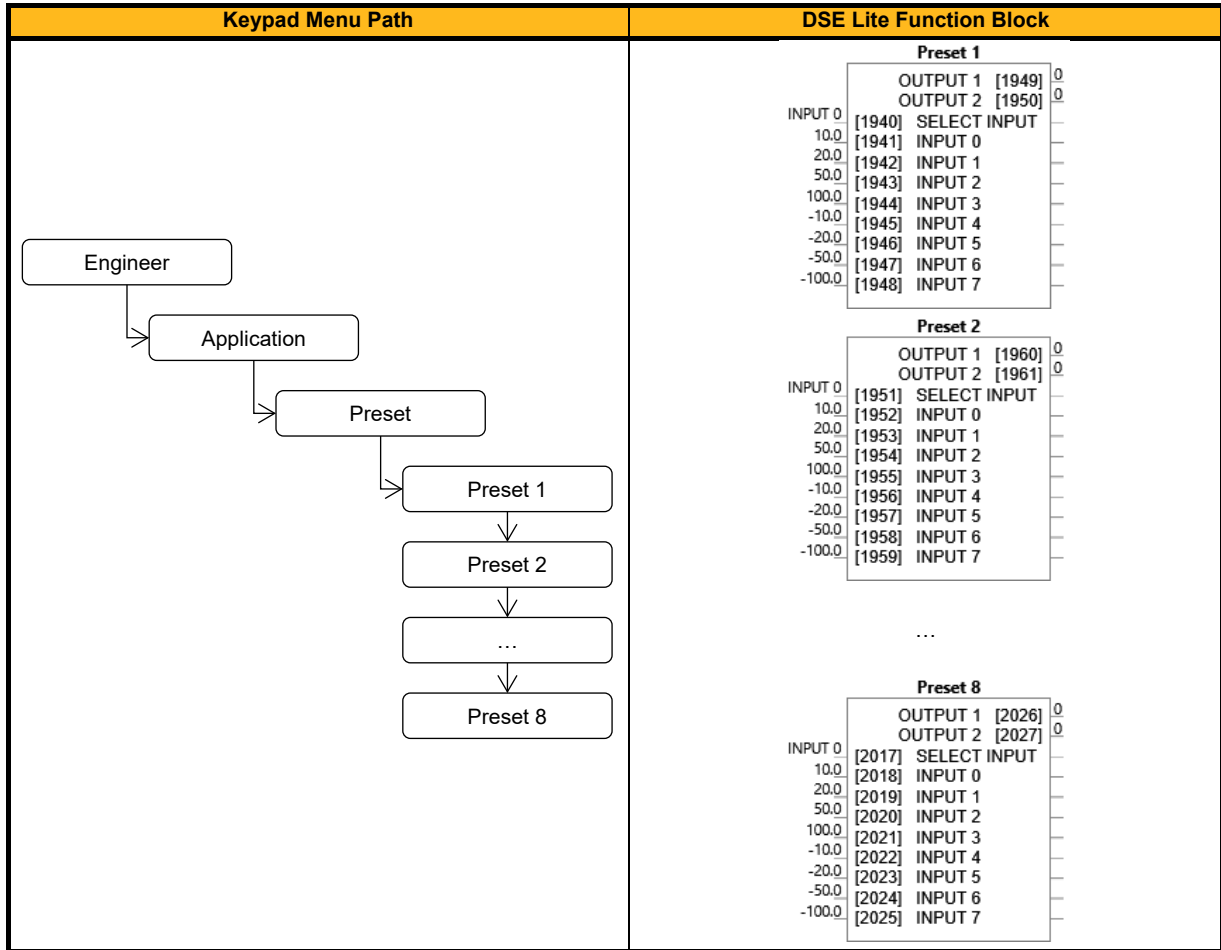

Function Block Inputs

Parameter Name	No.	Default Value	Range	Units	Type	Writable
SELECT INPUT						
Preset 1	1940	0: INPUT 0	0: INPUT 0		ENUM	ALWAYS
Preset 2	1951	0: INPUT 0	1: INPUT 1		ENUM	ALWAYS
...			
Preset 8	2017	0: INPUT 0	7: INPUT 7		ENUM	ALWAYS
Selects which input is copied to the output.						
INPUT 0						
Preset 1	1941	10.0	-32768.0 to 32767.0		REAL	ALWAYS
Preset 2	1952	10.0	-32768.0 to 32767.0		REAL	ALWAYS
...	...					
Preset 8	2018	10.0	-32768.0 to 32767.0		REAL	ALWAYS
Preset Output 1, when Selected Input = 0.						
INPUT 1						
Preset 1	1942	20.0	-32768.0 to 32767.0		REAL	ALWAYS
Preset 2	1953	20.0	-32768.0 to 32767.0		REAL	ALWAYS
...	...					
Preset 8	2019	20.0	-32768.0 to 32767.0		REAL	ALWAYS
Preset Output 1, when Selected Input = 1.						
INPUT 2						
Preset 1	1943	50.0	-32768.0 to 32767.0		REAL	ALWAYS
Preset 2	1954	50.0	-32768.0 to 32767.0		REAL	ALWAYS
...	...					
Preset 8	2020	50.0	-32768.0 to 32767.0		REAL	ALWAYS
Preset Output 1, when Selected Input = 2.						
INPUT 3						
Preset 1	1944	100.0	-32768.0 to 32767.0		REAL	ALWAYS
Preset 2	1955	100.0	-32768.0 to 32767.0		REAL	ALWAYS
...	...					
Preset 8	2021	100.0	-32768.0 to 32767.0		REAL	ALWAYS
Preset Output 1, when Selected Input = 3.						
INPUT 4						
Preset 1	1945	-10.0	-32768.0 to 32767.0		REAL	ALWAYS
Preset 2	1956	-10.0	-32768.0 to 32767.0		REAL	ALWAYS
...	ALWAYS
Preset 8	2022	-10.0	-32768.0 to 32767.0		REAL	ALWAYS
Preset Output 1, when Selected Input = 4.						
INPUT 5						
Preset 1	1946	-20.0	-32768.0 to 32767.0		REAL	ALWAYS
Preset 2	1957	-20.0	-32768.0 to 32767.0		REAL	ALWAYS
...	...					
Preset 8	2023	-20.0	-32768.0 to 32767.0		REAL	ALWAYS
Preset Output 1, when Selected Input = 5.						
INPUT 6						
Preset 1	1947	-50.0	-32768.0 to 32767.0		REAL	ALWAYS
Preset 2	1958	-50.0	-32768.0 to 32767.0		REAL	ALWAYS
...	...					
Preset 8	2024	-50.0	-32768.0 to 32767.0		REAL	ALWAYS
Preset Output 1, when Selected Input = 6.						
INPUT 7						
Preset 1	1948	-100.0	-32768.0 to 32767.0		REAL	ALWAYS
Preset 2	1959	-100.0	-32768.0 to 32767.0		REAL	ALWAYS
...	...					
Preset 8	2025	-100.0	-32768.0 to 32767.0		REAL	ALWAYS
Preset Output 1, when Selected Input = 7.						

Function Block Outputs

Parameter Name	No.	Default Value	Range	Units	Type	Writable
OUTPUT 1						
Preset 1	1949	0			REAL	NOT
Preset 2	1960	0			REAL	NOT
...	...					
Preset 8	2026	0			REAL	NOT
Output 1 (corresponding Selected Input).						
OUTPUT 2						
Preset 1	1950	0			REAL	NOT
Preset 2	1961	0			REAL	NOT
...	...					
Preset 8	2027	0			REAL	NOT
Output 2 (if Select Input is in the range 0 to 3, Input 4 to Input 7 respectively is routed to this Output).						

Functional Description

Output 1 and **Output 2** return the values at selected inputs set by **Select Input**.

Output 2 returns the value of a different input to **Output 1**:

if **Select Input** = 0 then **Output 1** = **Input 0**, **Output 2** = **Input 4**

if **Select Input** = 1 then **Output 1** = **Input 1**, **Output 2** = **Input 5** etc.

When **Select Input** is set to 4, 5, 6 or 7, **Output 2** will return a value of zero.

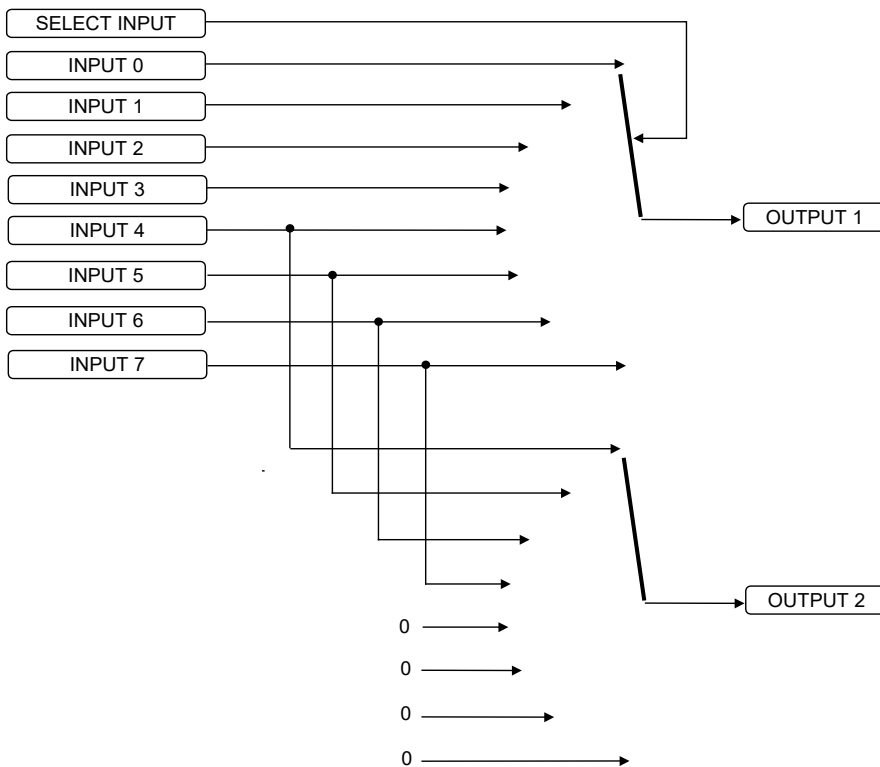

Product Data

Overview

Parameters that define the drive type and identity. These are set during manufacture and provided for information only.

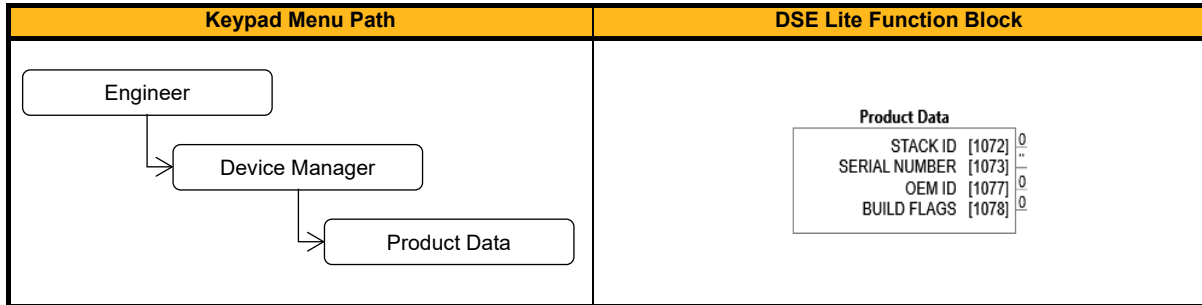

Function Block Outputs

Parameter Name	No.	Default Value	Range	Units	Type	Writable
STACK ID	1072	0			UINT	NOT
Numeric code identifying stack. Refer to the manual.						
SERIAL NUMBER	1073	"			STRING	NOT
The serial number of the drive.						
OEM ID	1077	0			UINT	NOT
Supplier identifier.						
BUILD FLAGS	1078	0: 0	0: - 1: - 2: - 3: - ... 15:-		WORD	NOT
Sixteen flags that indicate the build of the drive. This allows applications to be shared across drives to account for differences in drive types.						

Raise/Lower

Overview

This function block acts as an internal motorised potentiometer (MOP).
The Output is preserved during power-down of the drive.

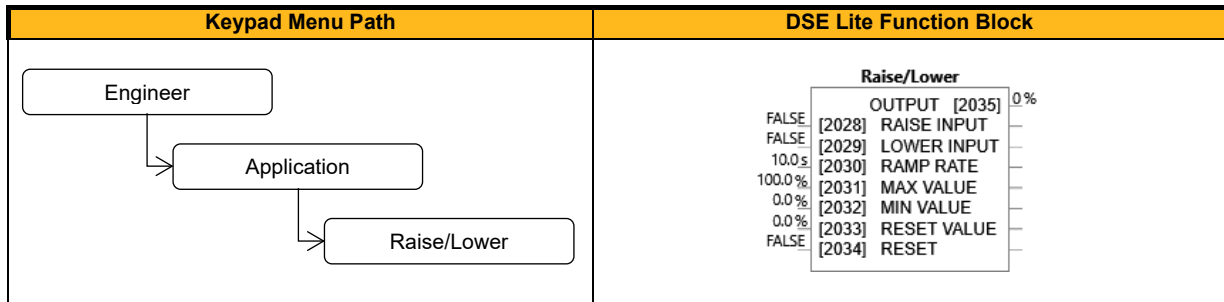

Function Block Inputs

Parameter Name	No.	Default Value	Range	Units	Type	Writable
RAISE INPUT	2028	FALSE			BOOL	ALWAYS
When TRUE causes Output to ramp up.						
LOWER INPUT	2029	FALSE			BOOL	ALWAYS
When TRUE causes Output to ramp down.						
RAMP RATE	2030	10.0	0.0 to 600.0	s	REAL	ALWAYS
Time to change from 0% to 100%						
MAX VALUE	2031	100.0	-100.0 to 100.0	%	REAL	ALWAYS
The maximum value to which the output will ramp.						
MIN VALUE	2032	0.0	-100.0 to 100.0	%	REAL	ALWAYS
The minimum value to which the output will ramp.						
RESET VALUE	2033	0.0	-100.0 to 100.0	%	REAL	ALWAYS
The value the output is set to when RESET is TRUE.						
RESET	2034	FALSE			BOOL	ALWAYS
When TRUE forces OUTPUT to track the RESET VALUE.						

Function Block Outputs

Parameter Name	No.	Default Value	Range	Units	Type	Writable
OUTPUT	2035	0	-32768.0 to 32767.0	%	REAL	NOT
The ramped output, this parameter is saved during the power-down of the drive.						

Functional Description

The table below describes how the Output is controlled by Raise Input, Lower Input and Reset Input.

Reset	Raise Input	Lower Input	Action
TRUE	Any	Any	Output tracks Reset Value
FALSE	TRUE	FALSE	Output ramps up to Maximum Value at Ramp Time
FALSE	FALSE	TRUE	Output ramps down to Minimum Value at Ramp Time
FALSE	FALSE	FALSE	Output not changed. *
FALSE	TRUE	TRUE	Output not changed. *

* If **2035 Output** is greater than **2031 Maximum Value** the Output will ramp down to Maximum Value at **2030 Ramp Rate**. If **2035 Output** is less than **2032 Minimum Value** the Output will ramp up to Minimum Value at **2030 Ramp Rate**.

This feature is run at a rate of 1 milli-second.

Note: If Maximum Value is less than or equal to Minimum Value, then Output is set to Maximum Value.

Reference Jog

Overview

This block holds all the parameters related to the Jog functionality on the Inverter.

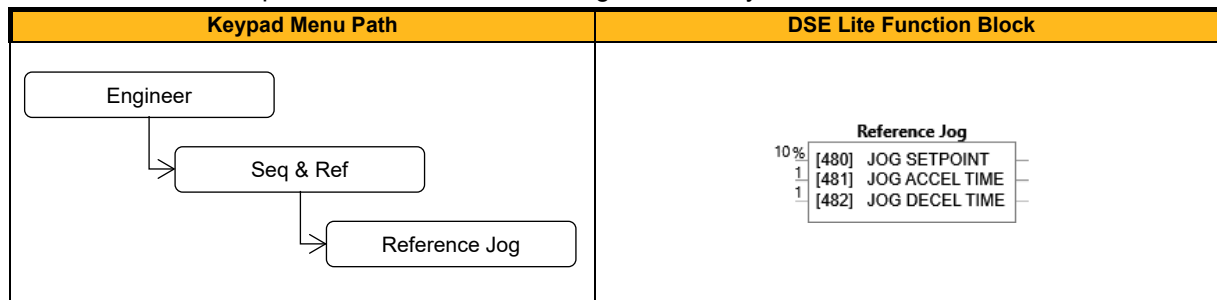

Function Block Inputs

Parameter Name	No.	Default Value	Range	Units	Type	Writable
JOG SETPOINT	480	10	0 to 100	%	REAL	ALWAYS
The setpoint is the target reference that the Drive will ramp to.						
JOG ACCEL TIME	481	1	0 to 3000		TIME	ALWAYS
The time that the Drive will take to ramp the jog setpoint from 0.00% to 100.00%.						
JOG DECEL TIME	482	1	0 to 3000		TIME	ALWAYS
The time that the Drive will take to ramp the jog setpoint from 100.00% to 0.00%.						

Functional Description

The Reference Jog function block is used to configure the action of the Inverter when used in jog mode.

Reference Ramp

Overview

This function block forms part of the reference generation. It provides the facility to control the rate at which the Inverter will respond to a changing setpoint demand.

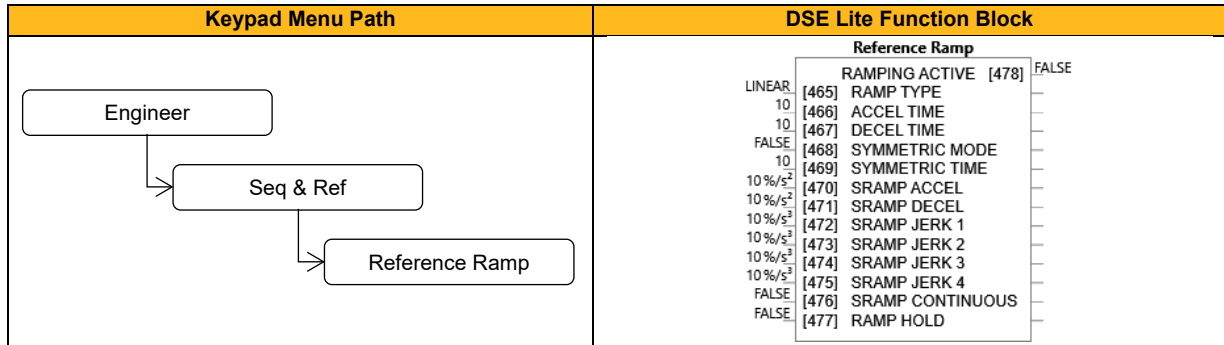

Function Block Inputs

Parameter Name	No.	Default Value	Range	Units	Type	Writable
RAMP TYPE	465	0: Linear	0: Linear 1: S Ramp		ENUM	ALWAYS
Selection of linear or S ramp.						
ACCEL TIME	466	10	0 to 3000		TIME	ALWAYS
The time that the Drive will take to ramp the setpoint from 0.00% to 100.00%, when Ramp Type is LINEAR.						
DECEL TIME	467	10	0 to 3000		TIME	ALWAYS
The time that the Drive will take to ramp the setpoint from 100.00% to 0.00%, when Ramp Type is LINEAR.						
SYMMETRIC MODE	468	FALSE			BOOL	ALWAYS
Select whether to use the ACCEL TIME and DECEL TIME pair of ramp rates, or to use the SYMMETRIC TIME parameter to define the ramp rate for the Drive.						
SYMMETRIC TIME	469	10	0 to 3000		TIME	ALWAYS
The time that the Drive will take to ramp from 0.00% to 100.00% and from 100.00% to 0.00% when SYMMETRIC MODE is TRUE.						
SRAMP ACCEL	470	10	0 to 100	%/s ²	REAL	ALWAYS
Sets the acceleration rate in units of [% / s ²], i.e. if the full speed of the machine is 1.25m/s then the acceleration will be: 1.25 x 75.00% = 0.9375m/s ² .						
SRAMP DECEL	471	10	0 to 100	%/s ²	REAL	ALWAYS
Sets the deceleration rate in units of [% / s ²], i.e. if the full speed of the machine is 1.25m/s then the deceleration will be: 1.25 x 75.00% = 0.9375m/s ² .						
SRAMP JERK 1	472	10	0 to 100	%/s ³	REAL	ALWAYS
Rate of change of acceleration for the first segment of the curve in units of [% / s ³], i.e. if the full speed of the machine is 1.25m/s then the jerk will be: 1.25 x 50.00% = 0.625m/s ³ .						
SRAMP JERK 2	473	10	0 to 100	%/s ³	REAL	ALWAYS
Rate of change of acceleration in units of [% / s ³] for segment 2.						
SRAMP JERK 3	474	10	0 to 100	%/s ³	REAL	ALWAYS
Rate of change of acceleration in units of [% / s ³] for segment 3.						
SRAMP JERK 4	475	10	0 to 100	%/s ³	REAL	ALWAYS
Rate of change of acceleration in units of [% / s ³] for segment 4.						
SRAMP CONTINUOUS	476	FALSE			BOOL	ALWAYS
When TRUE, and S ramp is selected in RAMP TYPE, forces a smooth transition if the speed setpoint is changed when ramping. The curve is controlled by the SRAMP ACCEL and SRAMP JERK 1 to SRAMP JERK 4 parameters. When FALSE, there is an immediate transition from the old curve to the new curve.						
RAMP HOLD	477	FALSE			BOOL	ALWAYS
When TRUE the output of the ramp is held at its last value.						

Function Block Outputs

Parameter Name	No.	Default Value	Range	Units	Type	Writable
RAMPING ACTIVE	478	FALSE			BOOL	NOT
Set TRUE when ramping.						

Functional Description

The ramp output takes the form shown below.

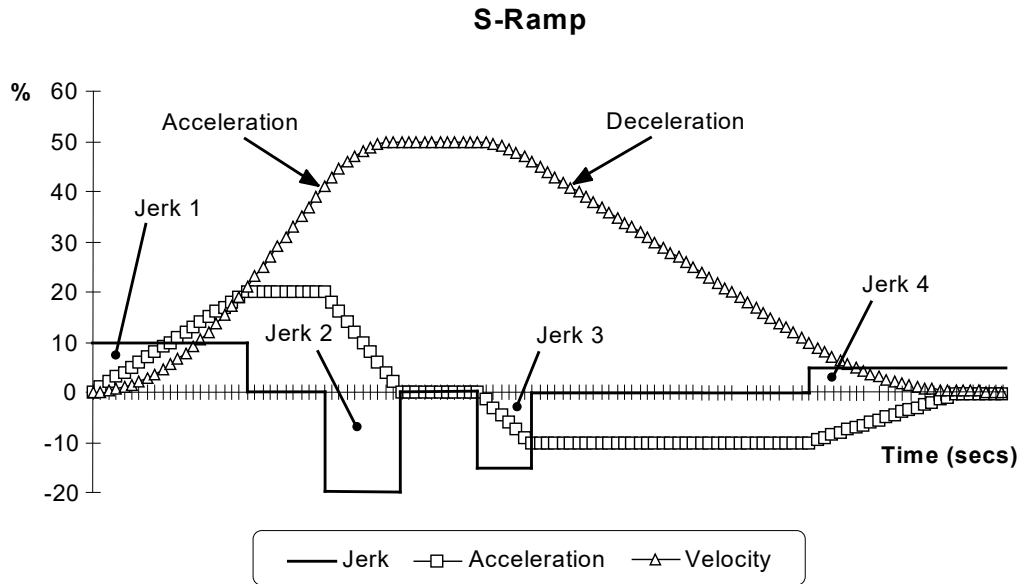

Reference Stop

Overview

This function block holds all the parameters related to the stopping method of the Inverter.

The stopping methods of the Inverter are described in more detail in the Product Manual.

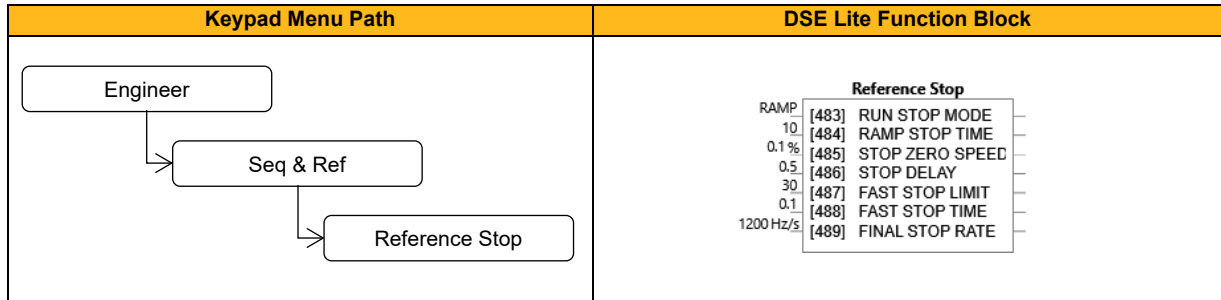

Function Block Inputs

Parameter Name	No.	Default Value	Range	Units	Type	Writable
RUN STOP MODE	483	0: Ramp	0: Ramp 1: Disabled Voltage 2: Dc Injection 3: Stop Ramp		ENUM	ALWAYS
Selects the stopping mode that the controller will use once the run command has been removed. When RUN RAMP is selected the Drive will decelerate using the reference ramp deceleration time, provided it is non-zero. When DISABLED VOLTAGE (COAST) is selected the motor will free-wheel. When DC INJECTION is selected the motor is stopped by applying low frequency and dc current. DC INJECTION is only possible with induction motors in VHz control mode - in vector modes the drive will coast to stop (as in mode 'VOLTAGE DISABLED'). When STOP RAMP is selected the motor will decelerate in STOP TIME. Note: another option to stop the drive is to trigger a fast (quick) stop via Parameter 0495 'Not Fast Stop' which has the advantage of an individual torque limitation parameter (Parameter 0387 'Fast Stop T_Lim') and timeout via Parameter 0487 'Fast Stop Limit'.						
RAMP STOP TIME	484	10	0 to 600		TIME	ALWAYS
Rate at which the demand is ramped to zero in run stop mode 'RAMP STOP' after the ramp has been quenched.						
STOP ZERO SPEED	485	0.1	0 to 100	%	REAL	ALWAYS
Threshold for zero speed detection in % max motor speed used by 'RAMP', 'STOP RAMP' and 'Fast (Quick) Stop' stop sequences. If the value given is below 0.5Hz that value will be used internally.						
STOP DELAY	486	0.5	0 to 30		TIME	ALWAYS
Sets the time at which the drive holds zero speed before quenching after a normal, stop ramp, quick (fast) stop or a jog stop. This may be particularly useful if a mechanical brake requires time to operate at zero speed, or for jogging a machine to position.						
FAST STOP LIMIT	487	30	0 to 3000		TIME	ALWAYS
Maximum time that the Drive will try to Fast (Quick) Stop, before quenching.						
FAST STOP TIME	488	0.1	0 to 600		TIME	ALWAYS
Rate (time from 100% speed) at which the Speed Demand is ramped to zero (100% speed – see Reference function block).						
FINAL STOP RATE	489	1200	1 to 4800	Hz/s	REAL	ALWAYS
Rate at which any internally generated setpoint trims are removed. For example, the trim due to the slip compensation in Volts/Hz control mode.						

Reference

Overview

This function block holds all the parameters concerning the generation of the setpoint reference.

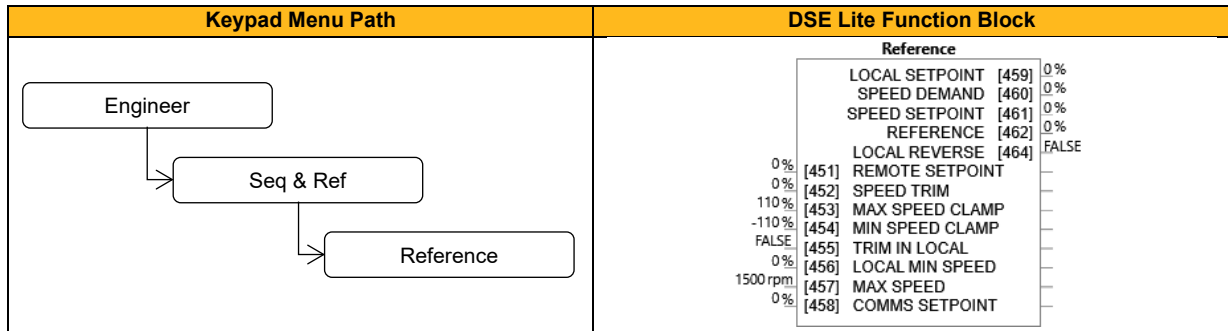

Function Block Inputs

Parameter Name	No.	Default Value	Range	Units	Type	Writable
REMOTE SETPOINT	451	0	-110 to 110	%	REAL	ALWAYS
This is the target reference, that the drive will ramp to in remote reference mode (not including trim), direction is taken from REMOTE REVERSE.						
SPEED TRIM	452	0	-300 to 300	%	REAL	ALWAYS
Speed setpoint added to the output of the ramp to form SPEED DEMAND (in local mode Speed Trim only is added, when Trim In Local is TRUE).						
MAX SPEED CLAMP	453	110	0 to 110	%	REAL	ALWAYS
Maximum value for Speed Demand.						
MIN SPEED CLAMP	454	-110	-110 to 0	%	REAL	ALWAYS
Minimum value for Speed Demand						
TRIM IN LOCAL	455	FALSE			BOOL	ALWAYS
When TRUE, the trim is added to the ramp output in local mode.						
LOCAL MIN SPEED	456	0	0 to 100	%	REAL	ALWAYS
The magnitude of the minimum setpoint that will be used when running in Local Mode.						
MAX SPEED	457	1500	0.1 to 100000	rpm	REAL	ALWAYS
Speed in rpm that matches 100% setpoint. Attention: Changing parameter P1006 'Nominal Supply' via keypad or webpage resets this parameter to the default value for the selected supply voltage/frequency. Note: I) Parameter P0457 can be modified while motor is running, but only by +/-10% (of value of P0457 Max speed): P0457_while_running = 0.9*P0457_start_running ... 1.1*P0457_start_running. II) The max electrical setpoint frequency applied to the motor is additionally limited to the lower of 590Hz, stack_pwm_frequeny_KHz*125 (Ind. motor) or stack_pwm_frequeny_KHz*166.66 (PMAC motor).						
COMMS SETPOINT	458	0	-110 to 110	%	REAL	ALWAYS
Reference from Fieldbus. This setpoint is the target reference in 'Remote Reference Comms' mode (not including trim). A positive value indicates a forward direction. 'Remote Reference Comms' mode is activated by setting bit 11 'use comms reference' in parameter 0436 'Comms Command'.						

Function Block Outputs

Parameter Name	No.	Default Value	Range	Units	Type	Writable
LOCAL SETPOINT	459	0	0 to 100	%	REAL	ALWAYS
Local Reference from GKP.						
SPEED DEMAND	460	0	-200 to 200	%	REAL	NOT
Actual speed demand after ramp and trims.						
SPEED SETPOINT	461	0	-200 to 200	%	REAL	NOT
Input speed setpoint to the ramp (equal either to LOCAL SETPOINT, REMOTE SETPOINT, JOG SETPOINT or COMMS SETPOINT).						
REFERENCE	462	0	-110 to 110	%	REAL	NOT
Monitor (read-only) Reference updated from the active source. This will either be the value of the Local Reference, App Reference (terminals) or Comms Reference depending on which source is currently selected.						
LOCAL REVERSE	464	FALSE			BOOL	NOT
Indicates the direction of motor rotation when in local reference mode.						

Functional Description

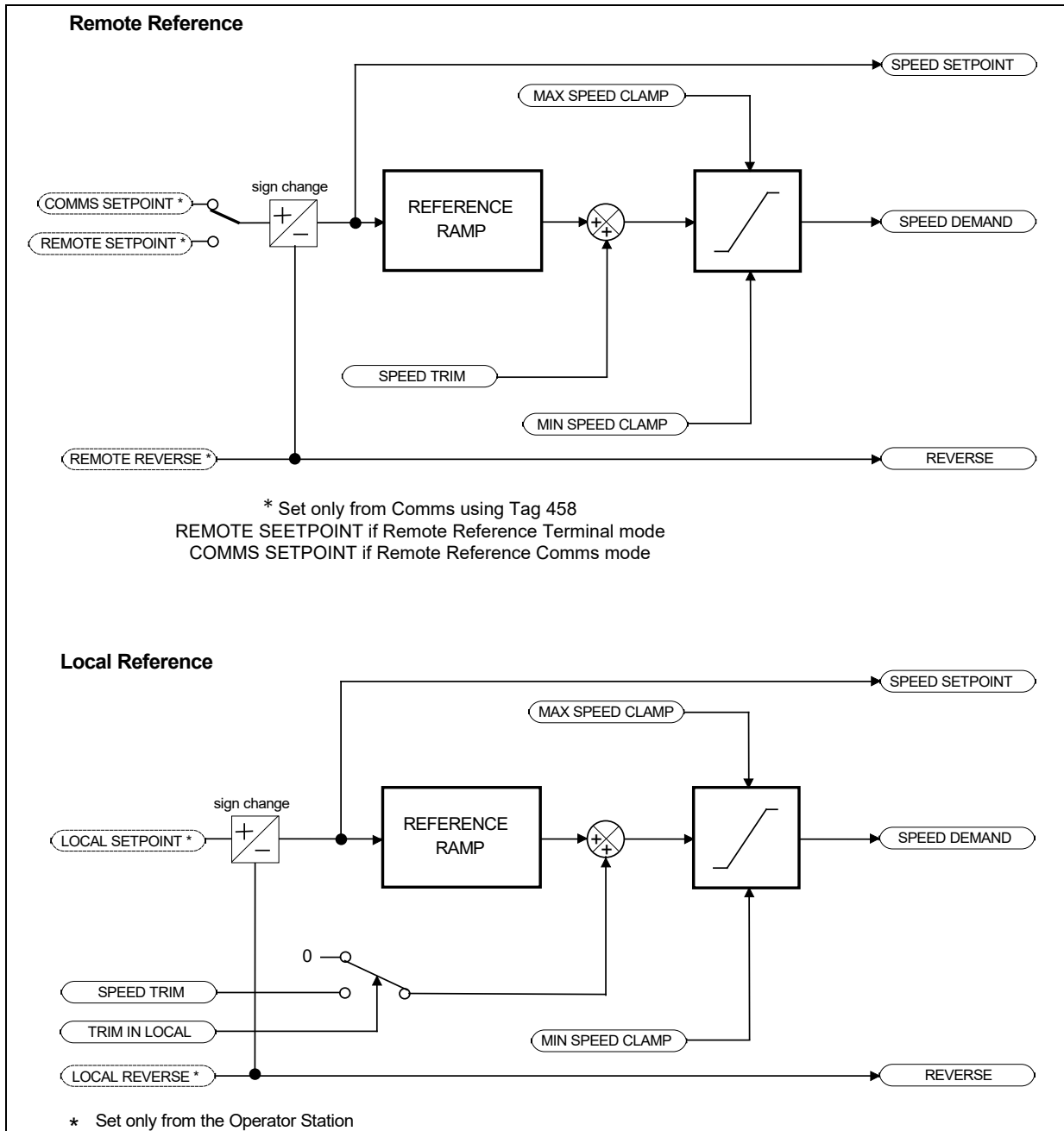

Relay 1 & Relay 2

Overview

The inverter supports 2 volt-free relay contacts, which can switch electrical devices.

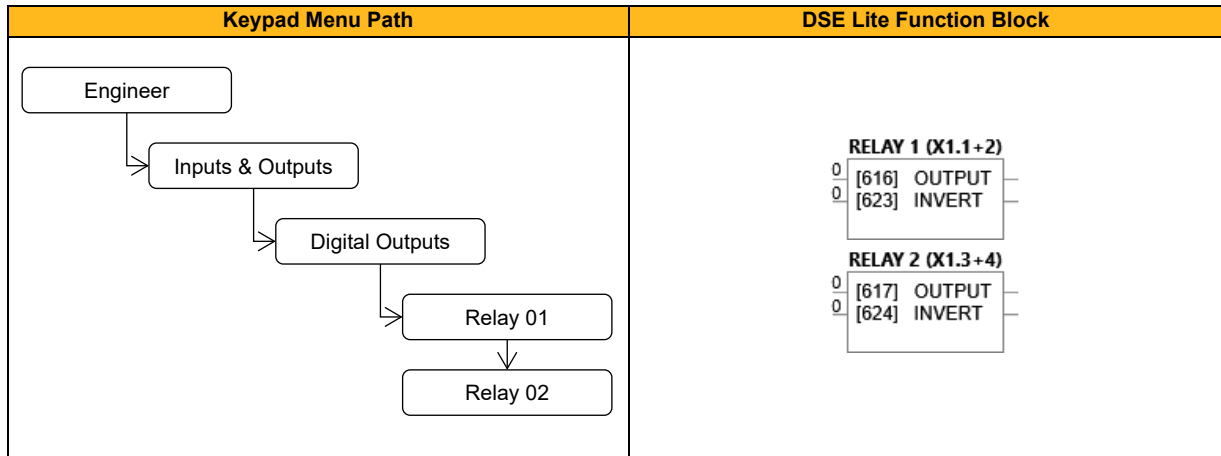

Function Block Inputs

Parameter Name	No.	Default Value	Range	Units	Type	Writable
OUTPUT						
RELAY 1 (X1.1/2)	616	0			BIT	ALWAYS
RELAY 2 (X1.3/4)	617	0			BIT	ALWAYS
Relay output before inversion.						
INVERT						
RELAY 1 (X1.1/2)	623	0			BIT	ALWAYS
RELAY 2 (X1.3/4)	624	0			BIT	ALWAYS
Invert relay output.						

Runtime Statistics

Overview

Parameters showing the usage of the drive.

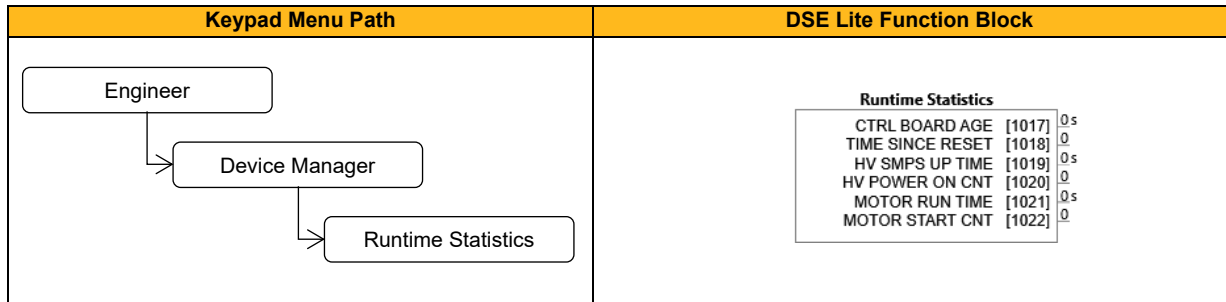

Function Block Outputs

Parameter Name	No.	Default Value	Range	Units	Type	Writable
CTRL BOARD AGE	1017	0		s	UDINT	NOT
Time for which the control board has been powered since new.						
TIME SINCE RESET	1018	0			TIME	NOT
Time in milliseconds since the control board was last powered, (either by 24V or 3-phase).						
HV SMPS UP TIME	1019	0		s	UDINT	NOT
Time for which the drive has been powered from the 3-phase supply.						
HV POWER ON CNT	1020	0			UINT	NOT
Number of times the 3-phase input has been connected to the drive.						
MOTOR RUN TIME	1021	0		s	UDINT	NOT
Time that the drive has been turning a motor. This value is held in the control module.						
MOTOR START CNT	1022	0			UDINT	NOT
A count of the total number of motor starts.						

Functional Description

The Runtime Statistics group of parameters indicate the working age of the drive. The Ctrl Board Age value is used as a reference when recording the time at which a trip occurs. Similarly, the HV SMPS Up Time is used as a reference when recording the time at which a disabled trip event occurs when the drive is operating in Fire Mode.

Sequencing

Overview

These parameters allow the user of the inverter to monitor the status and affect the behavior of the DS402 drive state machine as described in the software manual.

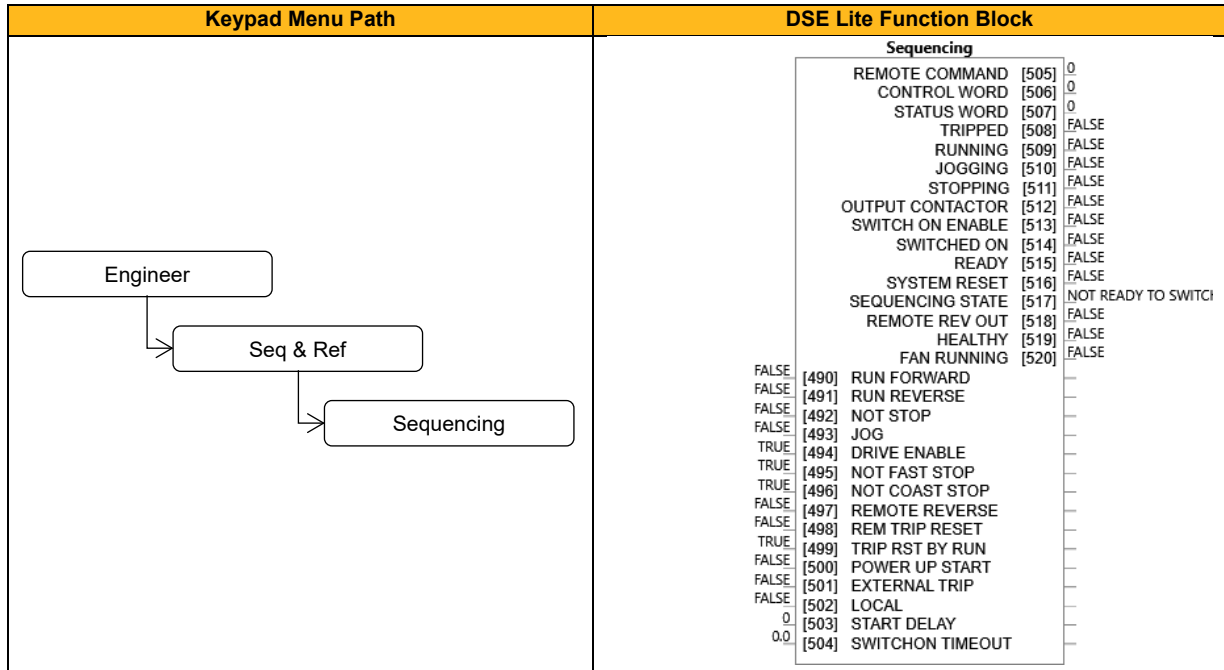

Function Block Inputs

Parameter Name	No.	Default Value	Range	Units	Type	Writable
RUN FORWARD	490	FALSE			BOOL	ALWAYS
Setting this parameter to TRUE causes the drive to run in the forward direction.						
RUN REVERSE	491	FALSE			BOOL	ALWAYS
Setting this parameter to TRUE causes the drive to run in the reverse direction.						
NOT STOP	492	FALSE			BOOL	ALWAYS
Setting this parameter TRUE will latch the RUN FWD or RUN REV commands. Once latched, they can be reset to FALSE and the Inverter will continue to run. Setting NOT STOP to False causes the run commands to be unlatched.						
JOG	493	FALSE			BOOL	ALWAYS
Setting this parameter TRUE causes the drive to run at the speed set by JOG SETPOINT (refer to the REFERENCE JOG function block). Once jogging, setting JOG to FALSE causes the drive to ramp to zero.						
DRIVE ENABLE	494	TRUE			BOOL	ALWAYS
This provides a means of electronically inhibiting drive operation. Whilst running, setting this parameter to FALSE disables the drive operation and causes the motor to coast.						
NOT FAST STOP	495	TRUE			BOOL	ALWAYS
Whilst running or jogging, setting this parameter to FALSE causes the drive to ramp to zero. The rate is set by Fast Stop Rate in the Stop function block. The Not Fast Stop input is latched when changed to TRUE until the stop action is completed.						
NOT COAST STOP	496	TRUE			BOOL	ALWAYS
Setting this parameter to FALSE disables the drive operation and causes the motor to coast to zero. The Not Coast Stop input is latched when changed to TRUE until the stop action is completed.						
REMOTE REVERSE	497	FALSE			BOOL	ALWAYS
For remote setpoints, setting this to TRUE inverts the demanded direction of motor rotation.						
REM TRIP RESET	498	FALSE			BOOL	ALWAYS
On a transition to TRUE, this input clears latched trips.						
TRIP RST BY RUN	499	TRUE			BOOL	ALWAYS
This allows the rising edge of run command to clear latched trips.						
POWER UP START	500	FALSE			BOOL	ALWAYS
If TRUE, this allows the drive to go directly to run mode if in remote and a run command is present. If FALSE, a low to high transition of the run command is required.						
EXTERNAL TRIP	501	FALSE			BOOL	ALWAYS
Setting this input to TRUE activates the External Trip.						
LOCAL	502	FALSE			BOOL	STOPPED

Local (HMI) Control and/or Reference.						
START DELAY	503	0	0 to 30		TIME	STOPPED
Time to delay the action of "ramping to setpoint" from the Run Command.						
SWITCHON TIMEOUT	504	0.0	0.0 to 100.0		TIME	ALWAYS
Time allowed for line contactor to close when entering the Switched On state from Switched Off state. If this time is non-zero, a Line Contactor trip will occur if the DC Link Voltage remains low until the timeout expires. If the timeout is set to zero, an Under Voltage trip will occur immediately.						

Function Block Outputs

Parameter Name	No.	Default Value	Range	Units	Type	Writable
REMOTE COMMAND	505	0: 0	0: Switch On 1: Enable Voltage 2: Not Quickstop 3: Enable Operation 4: 5: 6: 7: Reset Fault 8: External Fault 9: 10: Use Comms Control 11: Use Comms Reference 12: Use Jog Reference 13: Reverse Direction 14: 15: Event Triggered Op		WORD	NOT
Control Word indicating the commands that the Drive will action, generated from inputs to the sequencing block. Remote Command is further influenced by the Comms Command (Parameter 0436) if the Comms Command bit 10 (use comms control) is set true. In this case output bits 2 (Not Quickstop), 1 (Enable Voltage) and 0 (Switch On) from the Comms Command word are ANDed with the outputs of Remote Command.						
CONTROL WORD	506	0: 0	0: Switch On 1: Enable Voltage 2: Not Quickstop 3: Enable Operation 4: 5: 6: 7: Reset Fault 8: External Fault 9: 10: Use Comms Control 11: Use Comms Reference 12: Use Jog Reference 13: Reverse Direction 14: 15: Event Triggered Op		WORD	NOT
Monitor (read-only) Control Word updated from the active source.						
STATUS WORD	507	0: 0	0: Ready To Switch On 1: Switched On 2: Operation Enabled 3: Faulted 4: Voltage Enabled 5: Quickstop Inactive 6: Switch On Disabled 7: 8: 9: Control From Comms 10: 11: 12: Jog Operation 13: Reverse Operation 14: Reference From Comms 15: Stopping		WORD	NOT

DS402 Status Word.						
TRIPPED	508	FALSE			BOOL	NOT
Indicates that the drive is tripped.						
RUNNING	509	FALSE			BOOL	NOT
Indicates that the drive is running (powered state).						
JOGGING	510	FALSE			BOOL	NOT
Indicates that the drive is in the JOG mode.						
STOPPING	511	FALSE			BOOL	NOT
Indicates that the drive is stopping.						
OUTPUT CONTACTOR	512	FALSE			BOOL	NOT
Output to be used to drive an external contactor in the motor output. This contactor is normally closed unless a Trip condition has occurred or the drive goes into the re-configuration mode.						
SWITCH ON ENABLE	513	FALSE			BOOL	NOT
Sometimes referred to as READY TO SWITCH ON, this parameter indicates that the drive will accept a run command.						
SWITCHED ON	514	FALSE			BOOL	NOT
Run accepted. Waiting for CONTACTOR CLOSED and deflux to be completed.						
READY	515	FALSE			BOOL	NOT
Indicates that the drive's power stack is operable and the drive will run if enabled.						
SYSTEM RESET	516	FALSE			BOOL	NOT
TRUE for a single block diagram execution cycle after drive enters either RUN or JOG mode.						
SEQUENCING STATE	517	0: Not Ready To Switch On	0: Not Ready To Switch On 1: Switch On Disabled 2: Ready To Switch On 3: Switched On 4: Operation Enabled 5: Quickstop Active 6: Fault Reaction Active 7: Faulted		ENUM	NOT
Drive DS402 Sequencing State.						
REMOTE REV OUT	518	FALSE			BOOL	NOT
This parameter indicates the current state of remote direction and RUN REV. Note - this is the demanded direction, not the actual direction.						
HEALTHY	519	FALSE			BOOL	NOT
Set FALSE when the drive trips and set TRUE when the run command is removed. This output is False while the pre-charge relay is open on power-up.						
FAN RUNNING	520	FALSE			BOOL	NOT
This diagnostic is TRUE when the drive's cooling fans are running. The fans are running, when drive is running, and are stopped 60 seconds after the drive has stopped.						

Skip Frequencies

Overview

This function is used to prevent the Drive operating at frequencies that cause mechanical resonance in the load.

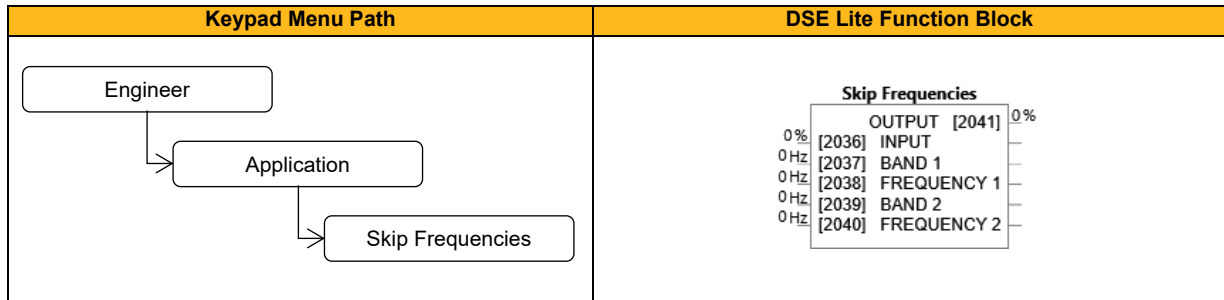

Function Block Inputs

Parameter Name	No.	Default Value	Range	Units	Type	Writable
INPUT	2036	0	-300.0 to 300.0	%	REAL	ALWAYS
The value of the block input in percent of the base frequency.						
BAND 1	2037	0	0.0 to 60.0	Hz	REAL	ALWAYS
The width of the skip band 1 in Hz.						
FREQUENCY 1	2038	0	0.0 to 300.0	Hz	REAL	ALWAYS
The center frequency of the skip band 1 in Hz.						
BAND 2	2039	0	0.0 to 60.0	Hz	REAL	ALWAYS
The width of the skip band 2 in Hz.						
FREQUENCY 2	2040	0	0.0 to 300.0	Hz	REAL	ALWAYS
The center frequency of the skip band 2 in Hz.						

Function Block Outputs

Parameter Name	No.	Default Value	Range	Units	Type	Writable
OUTPUT	2041	0		%	REAL	NOT
Output of the function block in percent of the base frequency.						

Functional Description

Four programmable skip frequencies are available to avoid resonances within the mechanical system. Enter the value of frequency that causes the resonance using a **Frequency** parameter and then program the width of the skip band using its **Band** parameter. The Drive will then avoid sustained operation within the forbidden band as shown in the diagram. The skip frequencies are symmetrical and thus work in forward and reverse.

Setting a **Frequency** to 0 disables the corresponding band. Setting a **Band** to 0 causes the value of **Band 1** to be used for this band.

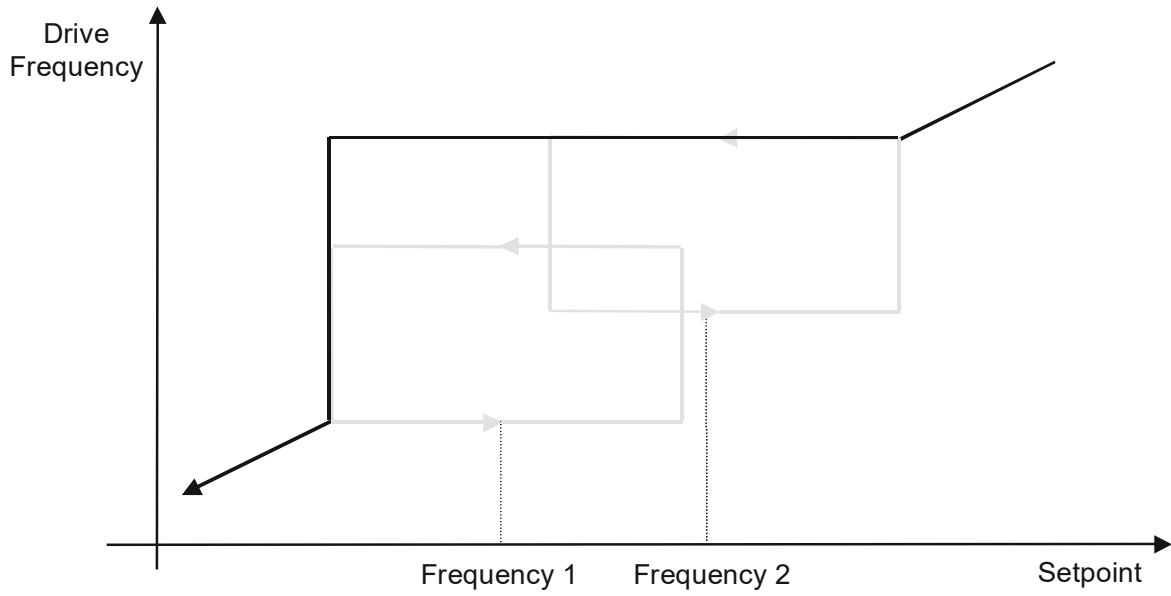

The behaviour of this function is illustrated below.

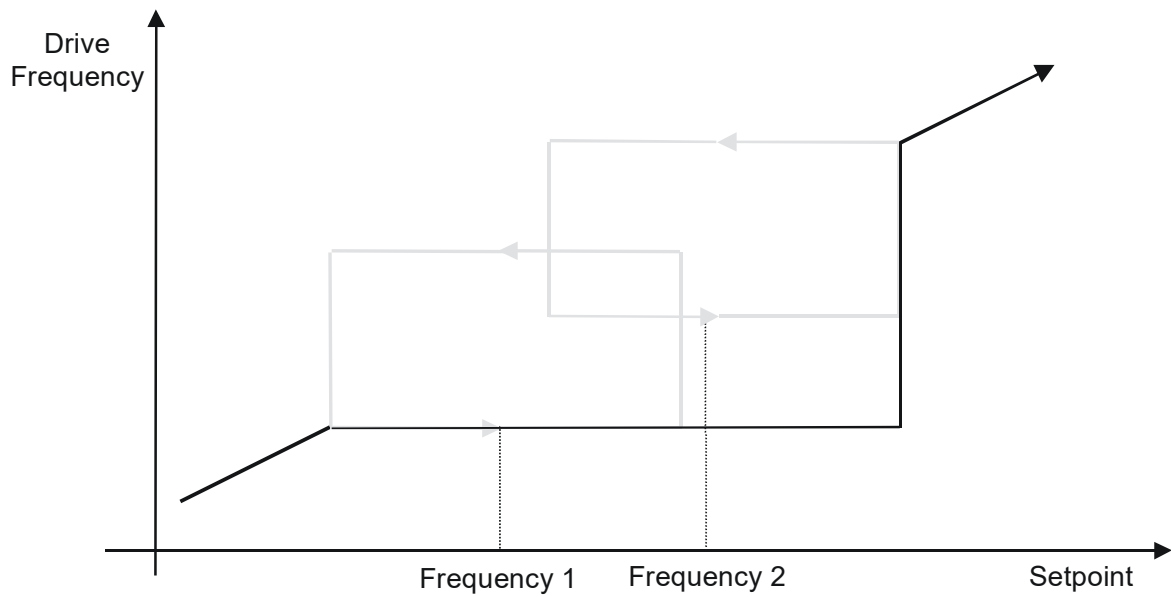
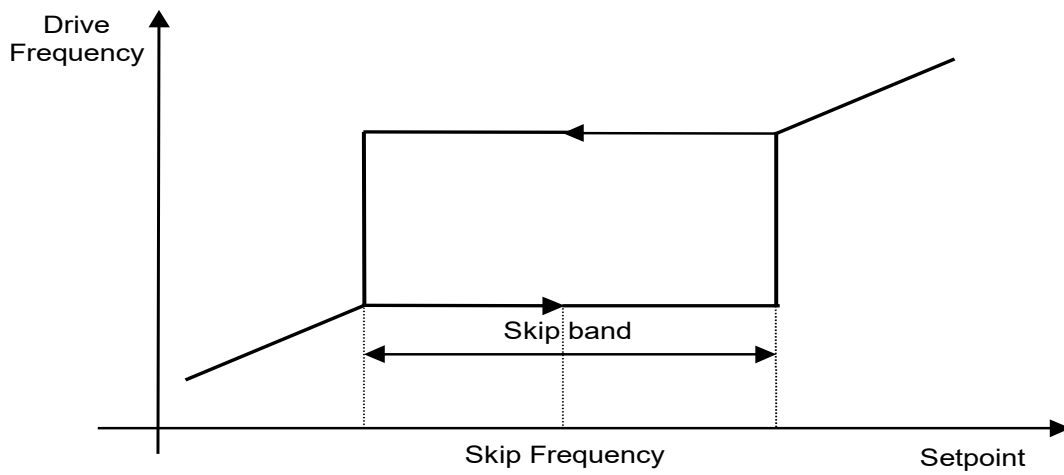

Slew Rate

Overview

Slew rate limit - all modes.

This function prevents over-current and over-voltage faults occurring due to a rapidly changing setpoint.

This is a useful feature for a stand-alone drive with or without dynamic braking as it protects against overvoltage trips. The Slew Rate Limit block uses the speed demand from the output of the Reference Ramp scaled by the Setpoint Scale block as the input. If Enable is FALSE, the output is passed unchanged to the speed loop. If TRUE, Accel Limit and Decel Limit prevent the setpoint from changing too fast. If the block clamps the output, it issues an internal HOLD to the Reference Ramp block. It may be necessary to reduce Accel Limit and Decel Limit to prevent the drive from tripping. Note: The lower you set the limits, the longer it will take to change speeds.

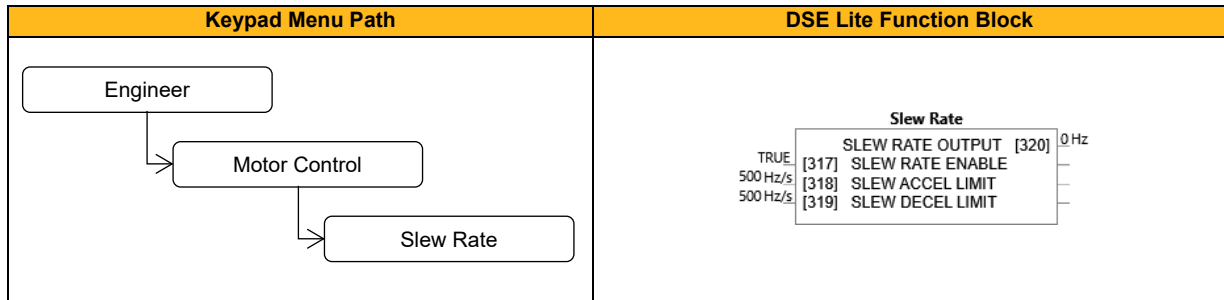

Function Block Inputs

Parameter Name	No.	Default Value	Range	Units	Type	Writable
SLEW RATE ENABLE	317	TRUE			BOOL	ALWAYS
Enable/Disable slew rate limit.						
SLEW ACCEL LIMIT	318	500	1 to 1200	Hz/s	REAL	ALWAYS
Maximum rate at which the setpoint can be changed away from zero.						
SLEW DECEL LIMIT	319	500	1 to 1200	Hz/s	REAL	ALWAYS
Maximum rate at which the setpoint can be changed towards zero.						

Function Block Outputs

Parameter Name	No.	Default Value	Range	Units	Type	Writable
SLEW RATE OUTPUT	320	0		Hz	REAL	NOT
Slew rate limited setpoint.						

Functional Description

The Slew Rate Limit block obtains the setpoint from the output of the application, correctly scaled by the Reference block and already processed by the Power Loss Ride Thru and the DC Link Volts Limit function blocks (if enabled). The rate of change limits is applied and the setpoint is then passed on for further processing.

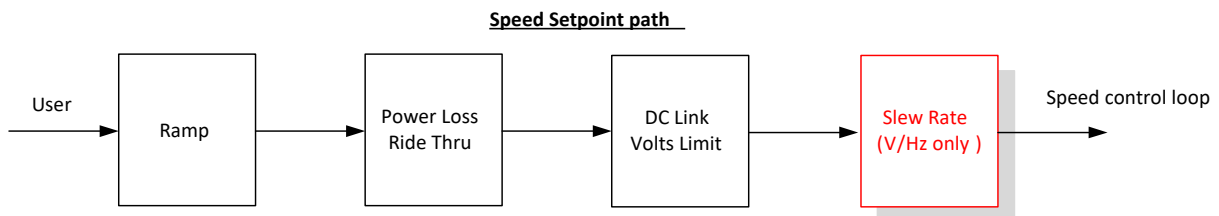

When the braking block determines that the internal dc link voltage is too high it issues a Hold signal. This causes the Slew Rate limit function to hold the setpoint at its current value. This typically lasts for only 1ms, time for the excess energy to be dumped into the dynamic braking resistor.

Slip Compensation

Overview

Designed for V/Hz motor Control Mode, the slip compensation function block allows the Inverter to maintain motor speed in the presence of increased load.

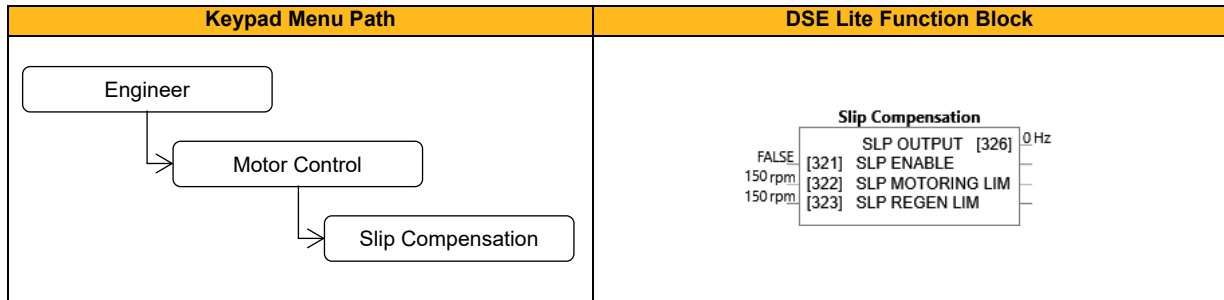

Function Block Inputs

Parameter Name	No.	Default Value	Range	Units	Type	Writable
SLP ENABLE	321	FALSE			BOOL	ALWAYS
Enable/Disable slip compensation.						
SLP MOTORING LIM	322	150	0 to 600	rpm	REAL	ALWAYS
Maximum compensated speed when driving the load.						
SLP REGEN LIM	323	150	0 to 600	rpm	REAL	ALWAYS
Maximum compensated speed in regen mode.						

Function Block Outputs

Parameter Name	No.	Default Value	Range	Units	Type	Writable
SLP OUTPUT	326	0		Hz	REAL	NOT
Setpoint with slip compensation trim added.						

Functional Description

Based on the rated speed, the no load speed and the rated load of the motor, the Slip Compensation function block adjusts the demand frequency to compensate for any speed reduction resulting from the load.

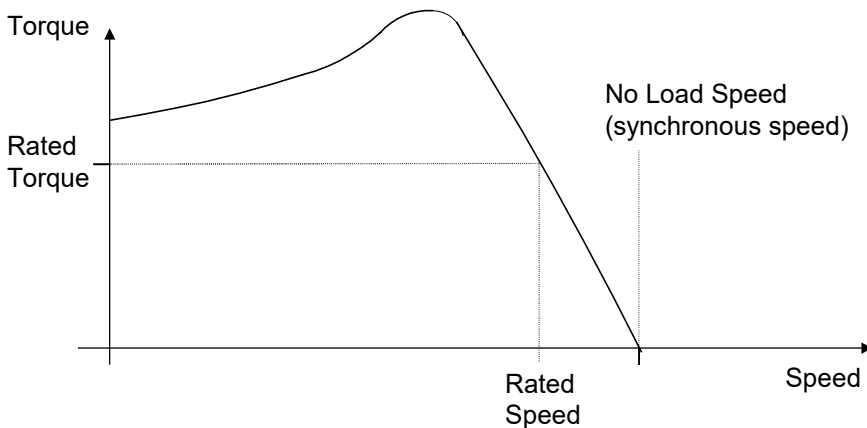

Spd Direct Input

Overview

Only applies to SVC Control Mode, Induction Motor or PMAC.

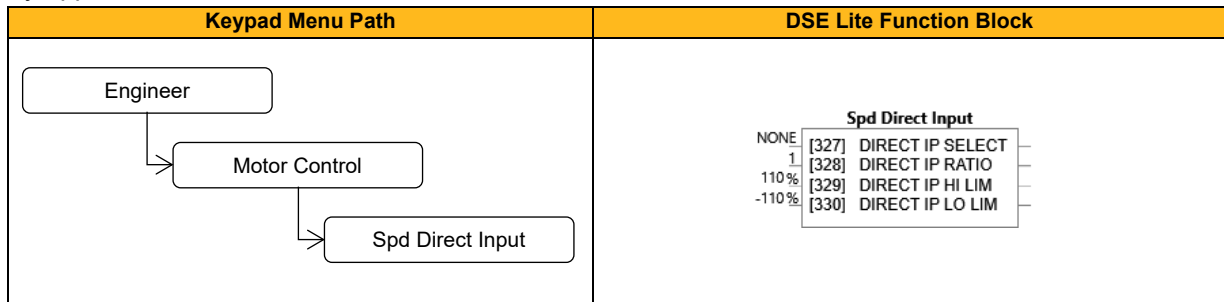

Function Block Inputs

Parameter Name	No.	Default Value	Range	Units	Type	Writable
DIRECT IP SELECT	327	0: None	0: None 1: Anin1 2: Anin2		ENUM	ALWAYS
The direct input to the speed loop is an analog input which is sampled synchronously with the speed loop. This ensures that the speed loop always has the most up-to-date value of the input, allowing it to respond faster. Either of the two analog inputs can be selected as the direct input. If NONE is selected, the input is set to zero. When not in use, it should be disabled by selecting NONE.						
DIRECT IP RATIO	328	1	-10 to 10		REAL	ALWAYS
The Direct Input is multiplied by this parameter.						
DIRECT IP HI LIM	329	110	-600 to 600	%	REAL	ALWAYS
This limits the upper value of the Direct Input.						
DIRECT IP LO LIM	330	-110	-600 to 600	%	REAL	ALWAYS
This limits the lower value of the Direct Input.						

Functional Description

The Drive is commanded to run the motor at a certain speed, which is derived from various sources, such as comms, analog inputs, commands from the keypad, etc. Most of these are derived from sources which respond relatively slowly, e.g. every 1ms. For processes which require a faster response, the direct input is provided. This is an analog input which is sampled synchronously with the speed loop, as described above. It is added on to the other sources of speed command to give a total speed command.

Speed Error Trip

Overview

This function allows the user to program the response of the drive in a situation where persistent speed error (as a difference between setpoint and actual measured or estimated speed) occurs.

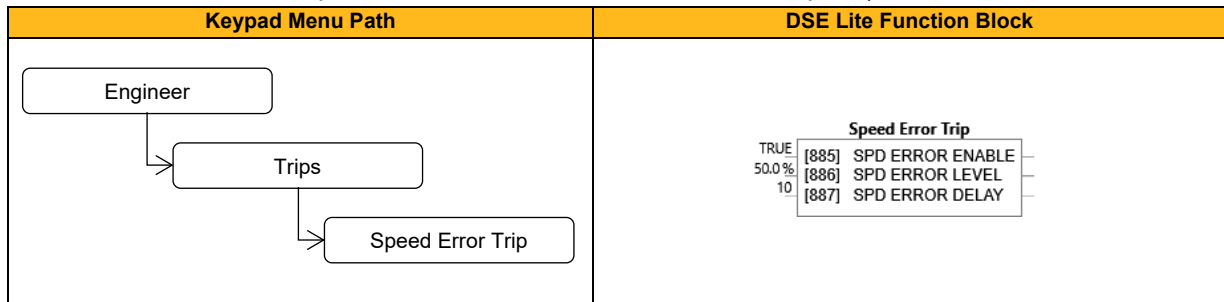

Function Block Inputs

Parameter Name	No.	Default Value	Range	Units	Type	Writable
SPD ERROR ENABLE	885	TRUE			BOOL	ALWAYS
Enables speed error trip.						
SPD ERROR LEVEL	886	50.0	0.0 to 100.0	%	REAL	ALWAYS
If speed error (difference between setpoint and actual measured speed) exceeds Speed Error Level for at least time period, which is defined in Spd Error Delay, speed error trip will be active.						
SPD ERROR DELAY	887	10	0 to 2000		TIME	ALWAYS
Time period corresponding with Spd Error Level for speed error trip activation.						

Functional Description

If the difference between the setpoint and the actual motor speed is greater than a level defined in parameter **0886 Speed Error Level** for a period longer than time defined in parameter **0887 Speed Error Delay**, the drive will trip. After half of that period a warning will be produced. This is only operational if enabled via parameter **0885 Speed Error Enable**.

Speed Loop

Overview

Only applies to Vector Control Mode, Induction Motor or PMAC.

This function block controls the speed of the motor by comparing the actual speed to the demanded speed and applying more or less torque in response to the error.

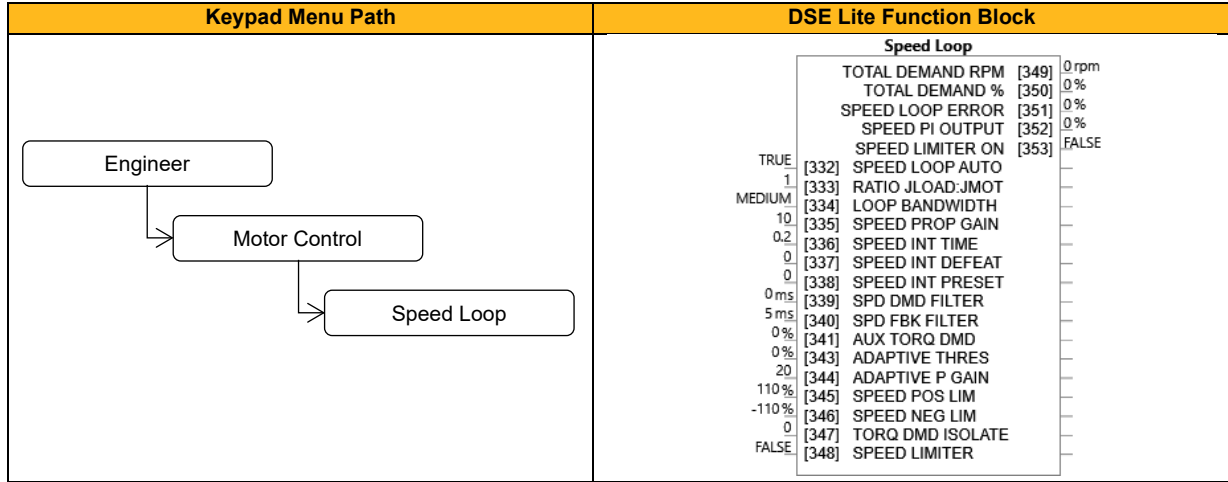

Function Block Inputs

Parameter Name	No.	Default Value	Range	Units	Type	Writable
SPEED LOOP AUTO	332	TRUE			BOOL	ALWAYS
Only for PMAC Motor. TRUE: Allows automatic calculation of speed loop control parameters Speed Prop gain (P0335) and Speed Int Time (P0336). For a correct estimation, the PMAC motor parameters PMAC Mot Inertia (P0288), PMAC Rated Torq (P0282) and speed loop parameter Ratio JLoad:JMot (P0333) need to be set correctly. FALSE: No automatic calculation.						
RATIO JLOAD:JMOT	333	1	0.1 to 100		REAL	ALWAYS
Enter the ratio between the load inertia and the motor inertia 'PMAC Mot inertia' (P0288). This parameter is used to estimate the correct Speed Loop Speed Prop Gain (P335) and Speed Int Time (P336). For PMAC motors. Notes: When there is no load, a value of 0.1 should be used (resulting in Jload = 0.1*Jmotor). If the total system inertia (JTotal = Jload + Jmotor) is known, the calculation for P333 is (JTotal - Jmotor) / Jmotor or (JTotal / Jmotor) -1. If a gearbox is connected to the motor the load inertia is equal to Jgearbox + Jload/i ² , where i=gearbox ratio						
LOOP BANDWIDTH	334	1: Medium	0: Low 1: Medium 2: High		ENUM	ALWAYS
When Speed Loop Auto (P0332) is TRUE, this parameter allows selection of the speed loop bandwidth level. Please note that the motor parameters PMAC Mot Inertia (P0288), PMAC Rated Torq (P0282) and speed loop parameter Ratio JLoad:JMot (P0333) need to be set correctly for best performance.						
SPEED PROP GAIN	335	10	0 to 3000		REAL	ALWAYS
Sets the proportional gain of the loop. Speed error (revolutions per second) x proportional gain = torque percent. Note: High gains might require additional tuning (speed filter, current control loop)						
SPEED INT TIME	336	0.2	0.001 to 15		TIME	ALWAYS
This is the integral time constant of the speed loop. A speed error which causes the proportional term to produce a torque demand T, will cause the integral term to also ramp up to a torque demand T after a time equal to "speed int time".						
SPEED INT DEFEAT	337	0			BOOL	ALWAYS
When TRUE, the integral term does not operate.						
SPEED INT PRESET	338	0	-600 to 600		REAL	ALWAYS
The integral term will be preset to this value when the drive starts.						
SPD DMD FILTER	339	0	0 to 50	ms	REAL	ALWAYS
The speed demand is filtered to reduce ripple. The filter is first order with time constant equal to the value of this parameter. Filter is off for values <= 1ms.						
SPD FBK FILTER	340	5	0 to 25	ms	REAL	ALWAYS
The speed feedback is filtered to reduce ripple. The filter is first order with time constant equal to the value of this parameter. Setting the filter to higher values also stabilizes the speed control loop in case of resonant (elastic) mechanic systems. Note:						

Too high values reduce phase reserve (closed loop control damping) and might lead to speed instability. In that case reduce the filter time or reduce the speed loop gain (select lower bandwidth or set lower P-gain). Filter is off for values <= 1ms.						
AUX TORQ DMD	341	0	-600 to 600	%	REAL	ALWAYS
When the drive is operating in speed control mode, the value of this parameter is added on to the torque demand produced by the speed loop PI. When the drive is operating in torque control mode (i.e. Torq Dmd Isolate (P0347) is TRUE) the speed loop PI does not operate, and the torque demand becomes the sum of this parameter plus the SPD DIRECT INPUT (if selected).						
ADAPTIVE THRES	343	0	0 to 10	%	REAL	ALWAYS
If the speed demand is less than the adaptive threshold, the speed loop proportional gain is the adaptive p-gain.						
ADAPTIVE P GAIN	344	20	0 to 300		REAL	ALWAYS
Proportional gain used if speed demand < adaptive threshold.						
SPEED POS LIM	345	110	-110 to 110	%	REAL	ALWAYS
This sets the upper limit of the speed demand.						
SPEED NEG LIM	346	-110	-110 to 110	%	REAL	ALWAYS
This sets the lower limit of the speed demand.						
TORQ DMD ISOLATE	347	0			BOOL	ALWAYS
Selects between Speed Control mode (FALSE) and Torque Control mode (TRUE). Note: Torque Control is only applicable in closed loop (encoder feedback) vector control.						
SPEED LIMITER	348	FALSE			BOOL	ALWAYS
Enable/disable speed limiter in torque control to prevent overspeed trip.						

Function Block Outputs

Parameter Name	No.	Default Value	Range	Units	Type	Writable
TOTAL DEMAND RPM	349	0	-100000 to 100000	rpm	REAL	NOT
This diagnostic shows the final values of the speed demand in rpm obtained after summing all sources. This is the value which is presented to the speed loop.						
TOTAL DEMAND %	350	0	-200 to 200	%	REAL	NOT
This diagnostic shows the final values of the speed demand as a % of MAX SPEED obtained after summing all sources. This is the value which is presented to the speed loop.						
SPEED LOOP ERROR	351	0	-600 to 600	%	REAL	NOT
This diagnostic shows the error between the total speed demand and the speed feedback.						
SPEED PI OUTPUT	352	0	-600 to 600	%	REAL	NOT
This diagnostic shows the torque demand % due to the speed loop PI output, not including any feedforward terms. Value is limited to actual torque limits.						
SPEED LIMITER ON	353	FALSE			BOOL	NOT
TRUE when speed limiter is active in Torque control (internal compensation of the Torque setpoint in order to keep the motor speed in min/max speed limit).						

Functional Description

The Speed Loop Error (speed demand minus speed feedback) is calculated and processed via a proportional + integral (PI) controller. The output of the PI controller is a torque demand, which is passed directly to the torque control block.

When the drive is in SENSORLESS VEC mode, the speed feedback is calculated using the voltages and currents flowing in the motor, and the motor model.

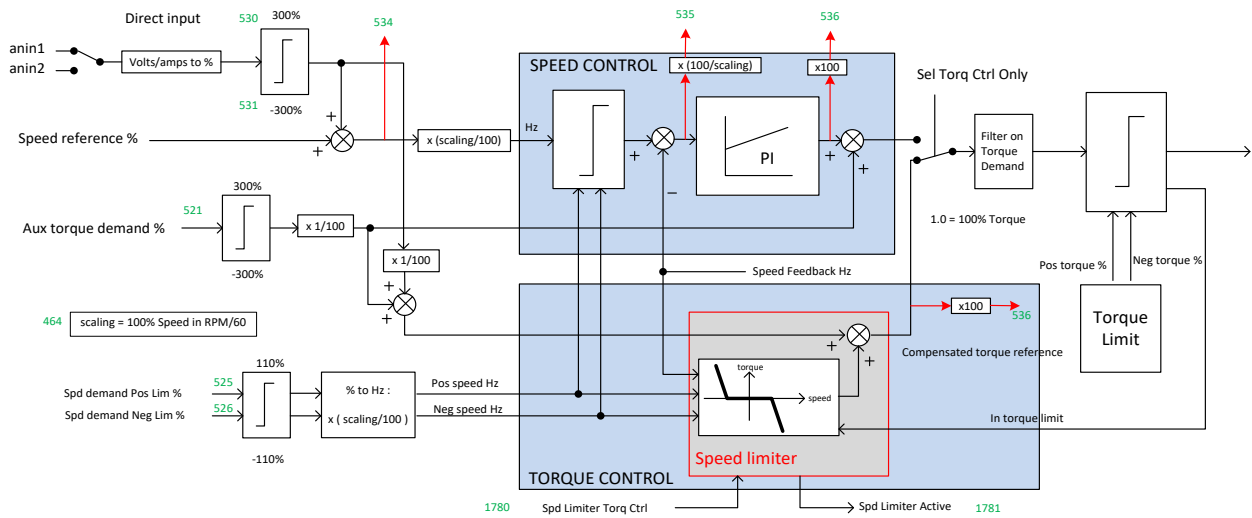

Stabilisation

Overview

Designed for V/Hz Control Mode.

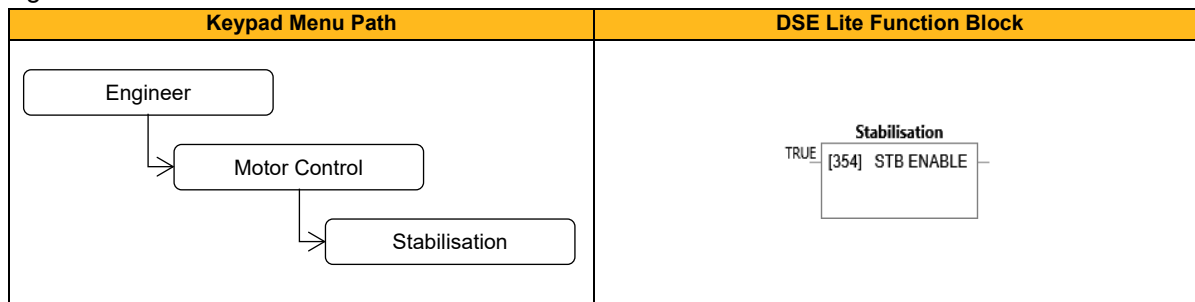

Function Block Inputs

Parameter Name	No.	Default Value	Range	Units	Type	Writable
STB ENABLE	354	TRUE			BOOL	ALWAYS
Enable/Disable stabilisation.						

Functional Description

Enabling this function reduces the problem of unstable running in induction motors. This can be experienced at approximately half full speed, and under low load conditions.

Stack Inv Time

Overview

The purpose of the inverse time is to automatically reduce the drive current limit in response to prolonged overload conditions.

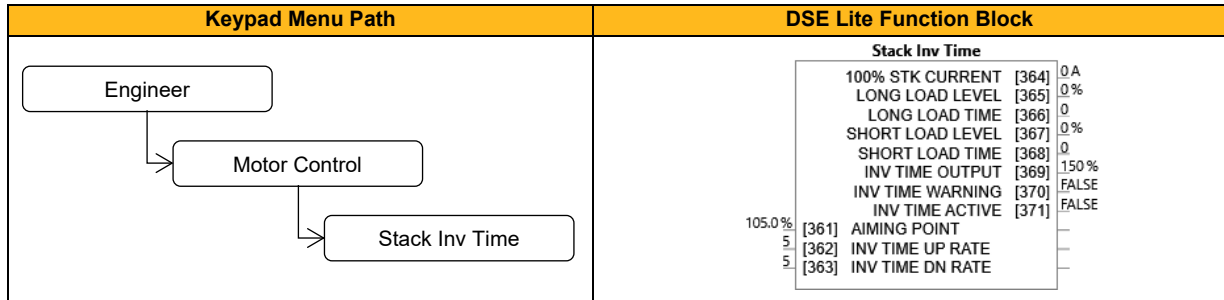

Function Block Inputs

Parameter Name	No.	Default Value	Range	Units	Type	Writable
AIMING POINT	361	105.0	0 to 125.0	%	REAL	ALWAYS
Current in % where the power stack can undertake the load current permanently.						
INV TIME UP RATE	362	5	0 to 120		TIME	STOPPED
Ramp value to ramp up current when overload current disappears.						
INV TIME DN RATE	363	5	0 to 120		TIME	STOPPED
Ramp value to reach the aiming point under prolonged overload condition.						

Function Block Outputs

Parameter Name	No.	Default Value	Range	Units	Type	Writable
100% STK CURRENT	364	0	0 to 10000	A	REAL	NOT
Stack rating in rms amps corresponding to 100% stack current.						
LONG LOAD LEVEL	365	0	0 to 200	%	REAL	NOT
Overload value in % of the stack amps for long overload condition.						
LONG LOAD TIME	366	0	0 to 100000		TIME	NOT
Maximum duration under long overload condition (typically 60s).						
SHORT LOAD LEVEL	367	0	0 to 200	%	REAL	NOT
Overload value in % of the stack amps for short overload condition						
SHORT LOAD TIME	368	0	0 to 10000		TIME	NOT
Maximum duration under short overload condition (typically 3s).						
INV TIME OUTPUT	369	150	0 to 600	%	REAL	NOT
Actual output current limit as a % of the stack current.						
INV TIME WARNING	370	FALSE			BOOL	NOT
The protection starts to integrate overload conditions.						
INV TIME ACTIVE	371	FALSE			BOOL	NOT
The drive protection is limiting the output current.						

Functional Description

For a short time given by Short Load Time, the drive is able to provide the Short Overload Level.

For a long time given by Long Load Time, the drive is able to provide the Long Overload Level.

These 2 protections work in parallel. The output limit current is the maximum value if **0371 Inv Time Active** = False. If **0371 Inv Time Active** = True, the current limit is determined by Long Overload Level. After the configured load time, the current limit is ramped down due to the long overload.

When the maximum overload value is reached, the inverse time current limit is ramped down. The rate at which the inverse time current limit is ramped to **0361 Inv Aiming Point** is defined by **0363 Inv Time Dn Rate**.

When the overload condition disappears, the inverse time current limit is ramped up. The rate at which the inverse time current limit is ramped to the maximum value is defined by **0362 Inv Time Up Rate**.

The load levels are all configured in % of drive/stack ratings.

Stall Trip

Overview

The function protects the motor from damage that may be caused by continuous operation beyond specification.

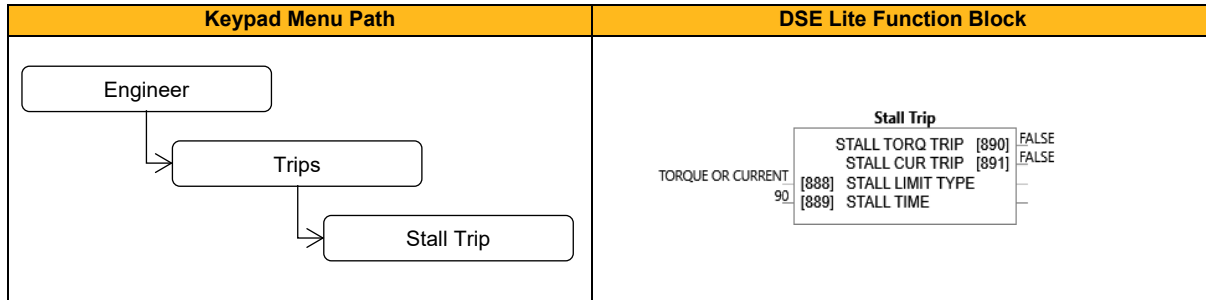

Function Block Inputs

Parameter Name	No.	Default Value	Range	Units	Type	Writable
STALL LIMIT TYPE	888	2: Torque Or Current	0: Torque 1: Current 2: Torque Or Current		ENUM	ALWAYS
This parameter determines whether the stall trip operates on motor torque, on motor current, on motor torque or motor current. Note: In VHz mode it can happen that only the current limit triggers (as the torque limits are used to limit voltage and thus current in VHz mode).						
STALL TIME	889	90	0.1 to 2000		TIME	ALWAYS
The time after which a continuous stall condition will cause a trip. A warning is given after half of this time.						

Function Block Outputs

Parameter Name	No.	Default Value	Range	Units	Type	Writable
STALL TORQ TRIP	890	FALSE			BOOL	NOT
TRUE if motor is in torque stall operation, trip if torque or current and torque based stall trip is enabled and situation lasts for P0889 stall time. Conditions for vector control: Low motor speed (95% of MIN(pos P0389 or neg P0390 actual torque limit). Conditions for V/Hz control: V/Hz actual torque for stall (P2471) > 95% of MIN(pos P0389 or neg P0390 torque limit). Note actual torque limits could be altered cyclic for current limitation in V/Hz mode.						
STALL CUR TRIP	891	FALSE			BOOL	NOT
TRUE if motor is in current based stall operation, trip if 'current' or 'current and torque' based stall trip type is set and situation lasts for P0889 stall time. Conditions for vector control: Low motor speed (95% of effective current limit P0056. Conditions for V/Hz control: Actual motor current pctn P0111 > 100% of effective current limit P0056 or VHz current limitation action (via actual torque limits) ongoing (P2470).						

Functional Description

If **0888 Stall Limit Type** is set to TORQUE and the estimated load exceeds the active Torque Limit for a time greater than **0889 Stall Time**, then the stall trip will become active.

If **0888 Stall Limit Type** is set to CURRENT and the measured current exceeds the active Current Limit for a time greater than **0889 Stall Time**, then the stall trip will become active.

The timer is reset whenever the estimated load is less than the active Limit.

Thermistor Trip

Overview

Defines the thermistor type. This is used when generating the MOTOR OVERTEMP trip.

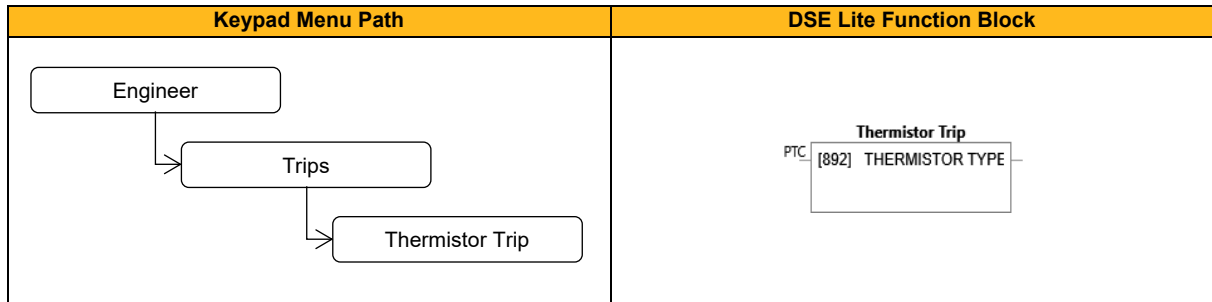

Function Block Inputs

Parameter Name	No.	Default Value	Range	Units	Type	Writable
THERMISTOR TYPE	892	0: PTC	0: PTC 1: NTC		ENUM	ALWAYS

The thermistor input is designed for a Positive Temperature Coefficient thermistor, but it can accept many Negative Temperature Coefficient thermistors.

Timer 1 & Timer 2

Overview

This block records the total time that an application or function has been running.

The function block maintains the elapsed time as a count of seconds. This value is updated at the function block execution period and is accurate to within one second. The elapsed time is preserved during the power-down of the drive.

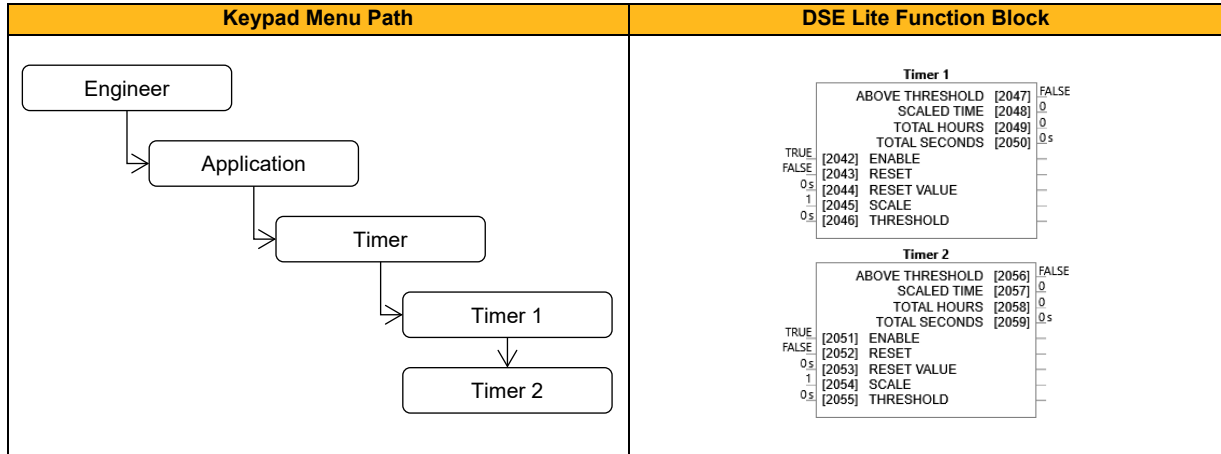

Function Block Inputs

Parameter Name	No.	Default Value	Range	Units	Type	Writable
ENABLE						
Timer 1	2042	TRUE			BOOL	ALWAYS
Timer 2	2051	TRUE			BOOL	ALWAYS
Enables counting, the block is enabled by default. When FALSE, the elapsed time is held at the present value. When TRUE, the elapsed time continues to increment from the held value.						
RESET						
Timer 1	2043	FALSE			BOOL	ALWAYS
Timer 2	2052	FALSE			BOOL	ALWAYS
Used together with Reset Value to pre-set the timer to a desired value. Reset is level sensitive, (not edge). Setting Reset to FALSE has no effect.						
RESET VALUE						
Timer 1	2044	0	0 to 2147483647	s	DINT	ALWAYS
Timer 2	2053	0	0 to 2147483647	s	DINT	ALWAYS
Used together with the Reset input to pre-set the timer to a desired value.						
SCALE						
Timer 1	2045	1	1 to 2147483647		DINT	ALWAYS
Timer 2	2054	1	1 to 2147483647		DINT	ALWAYS
This input is used to produce the customizable timer output 'Scaled Time' from the internal seconds counter. For example, a value of 1 gives an output in seconds, a value of 60 gives minutes, 3600 gives hours.						
THRESHOLD						
Timer 1	2046	0	-2147483648 to 2147483647	s	DINT	ALWAYS
Timer 2	2055	0	-2147483648 to 2147483647	s	DINT	ALWAYS
Controls the upper limit and roll-over behaviour of the timer. Total Seconds is compared with threshold absolute value. If Threshold is negative, the timer is reset, when the threshold value is exceeded. If Threshold is positive, Output Above Threshold is set, but Timer continues counting, when the threshold value is exceeded.						

Function Block Outputs

Parameter Name	No.	Default Value	Range	Units	Type	Writable
ABOVE THRESHOLD						
Timer 1	2047	FALSE			BOOL	NOT
Timer 2	2056	FALSE			BOOL	NOT
TRUE when the timer value is greater than or equal to the absolute value of Threshold.						
SCALED TIME						
Timer 1	2048	0			REAL	NOT
Timer 2	2057	0			REAL	NOT
The result of Total Seconds / Scale.						
TOTAL HOURS						
Timer 1	2049	0	0 to 596523		DINT	NOT
Timer 2	2058	0	0 to 596523		DINT	NOT
The timer value in hours with no fractional part.						
TOTAL SECONDS						
Timer 1	2050	0	0 to 2147483647	s	DINT	NOT
Timer 2	2059	0	0 to 2147483647	s	DINT	NOT
The elapsed time expressed in seconds.						

Functional Description

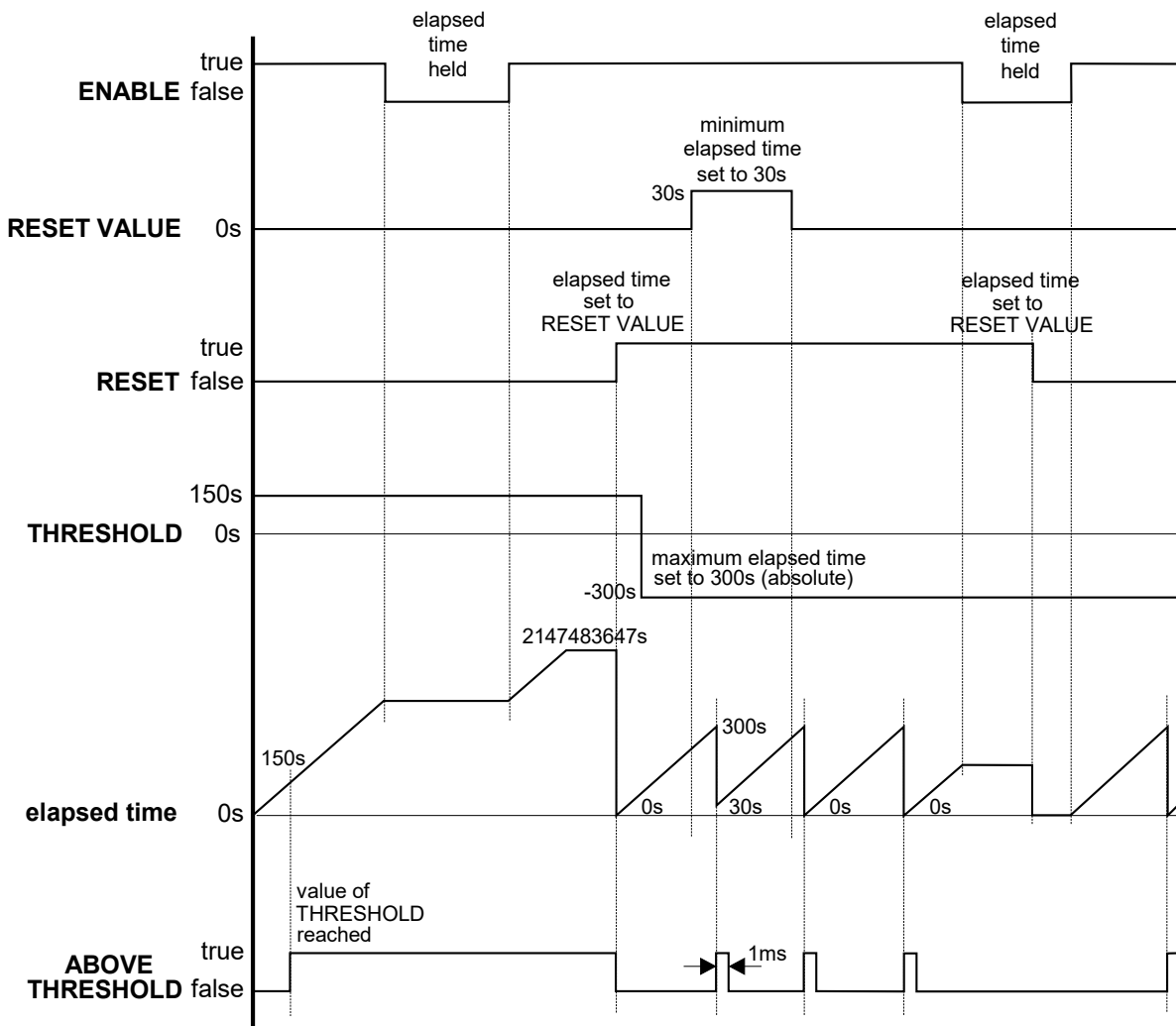

Torque Dmd Filtr

Overview

Selects the type of filter applied to the Torque setpoint. Either the output of the speed loop block is used (if the speed loop is active) or the torque setpoint (if Torque Demand isolate is active) is used as input.

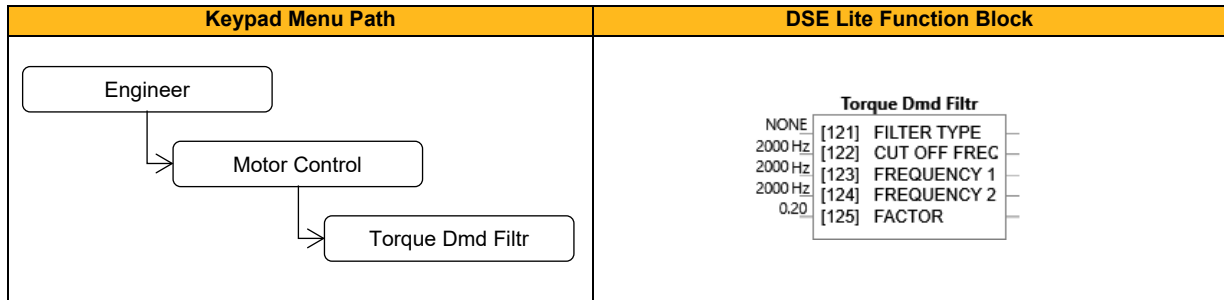

Function Block Inputs

Parameter Name	No.	Default Value	Range	Units	Type	Writable
FILTER TYPE	121	0: None	0: None 1: Max Attenuation 2: Minimum Phase 3: Phase Advance 4: Notch		ENUM	ALWAYS
Filter Type Selection.						
CUT OFF FREQ	122	2000	20 to 6000	Hz	REAL	ALWAYS
Filter Cut Off Frequency.						
FREQUENCY 1	123	2000	20 to 6000	Hz	REAL	ALWAYS
Frequency 1 for advanced phase filter.						
FREQUENCY 2	124	2000	20 to 6000	Hz	REAL	ALWAYS
Frequency 2 for advanced phase filter.						
FACTOR	125	0.20	0.10 to 1.00		REAL	ALWAYS
Damping factor.						

Functional Description

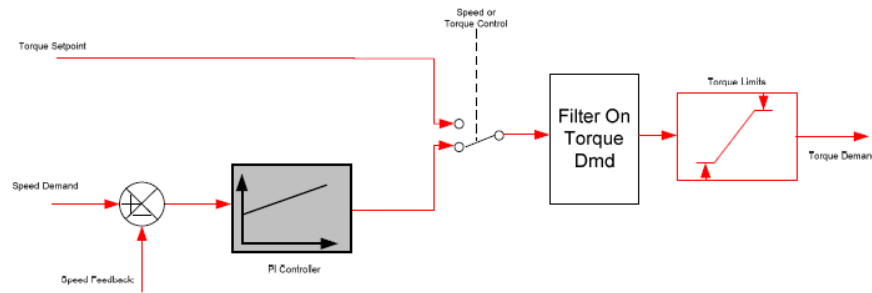

The general structure of the filter is given below :

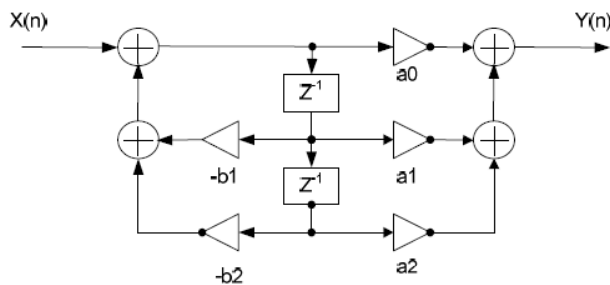

$$H(z) = \frac{a_0 + a_1 \cdot z^{-1} + a_2 \cdot z^{-2}}{1 + b_1 \cdot z^{-1} + b_2 \cdot z^{-2}} \quad \text{or} \quad y_n = a_0 \cdot x_n + a_1 \cdot x_{n-1} + a_2 \cdot x_{n-2} - b_1 \cdot y_{n-1} - b_2 \cdot y_{n-2}$$

Torque Limit

Overview

This function allows you to set the maximum level of motor rated torque which is allowed before torque limit action occurs.

If the estimated motor torque is greater than the **0389 Actual Pos Lim** value, the motor speed is controlled to maintain the torque at this level. A similar situation occurs if the estimated motor torque is less than the **0390 Actual Neg Lim** value.

The torque limit function has separate positive and negative torque limits. In addition, a symmetric main torque limit is also provided.

The lowest positive and negative torque limits (including any current limit or inverse time current limit action) is indicated in the **0389 Actual Pos Lim** and **0390 Actual Neg Lim** diagnostic. These values determine the absolute motor torque limits.

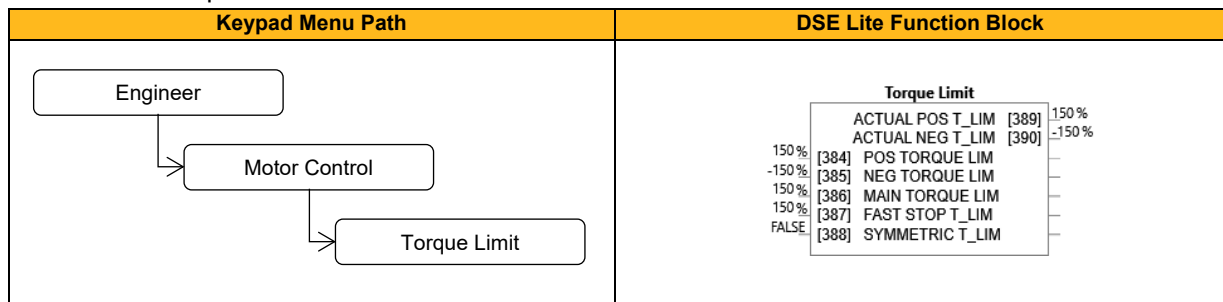

Function Block Inputs

Parameter Name	No.	Default Value	Range	Units	Type	Writable
POS TORQUE LIM	384	150	-600 to 600	%	REAL	ALWAYS
This parameter defines the normal operation upper torque limit. For positive values it defines maximum allowed level of positive motor torque. For negative values it defines the minimal (=upper) negative torque limit (internally the value then is limited to P385). Note: While in VHz control mode torque limiting might lead to undesired or unexpected behavior. For details see P0055 'Regen. Limit VHz' description.						
NEG TORQUE LIM	385	-150	-600 to 600	%	REAL	ALWAYS
This parameter defines the normal operation lower torque limit. For negative values it defines maximum allowed level of negative motor torque. For positive values it defines the minimal (=lower) positive torque limit (internally the value is then limited to P384). Note: While in VHz control mode torque limiting might lead to undesired or unexpected behavior. For details see P0055 'Regen. Limit VHz' description.						
MAIN TORQUE LIM	386	150	0 to 600	%	REAL	ALWAYS
This parameter sets the maximum allowed normal operation motor torque (=the symmetric (magnitude upper) limit for Pos P0384 and Neg P0384 Torque Limit). This parameters can be seen as an additional limiter for P384 and P385 values. Note: While in VHz control mode torque limiting might lead to undesired or unexpected behavior. For details see P0055 'Regen. Limit VHz' description.						
FAST STOP T_LIM	387	150	0 to 600	%	REAL	ALWAYS
This parameter sets the torque limit used during a Fast (Quick) Stop. It overrides the normal operation torque limiting parameters P384 to P386. Note: While in VHz control mode torque limiting might lead to undesired or unexpected behavior. For details see P0055 'Regen. Limit VHz' description.						
SYMMETRIC T_LIM	388	FALSE			BOOL	ALWAYS
When TRUE, the internal NEG TORQUE LIM is forced to reflect the POS TORQUE LIM parameter P384.						

Function Block Outputs

Parameter Name	No.	Default Value	Range	Units	Type	Writable
ACTUAL POS T_LIM	389	150	-600 to 600	%	REAL	NOT
This diagnostic indicates the final actual positive (upper) torque limit including any user current limit or inverse time (power stack) current limit action.						
ACTUAL NEG T_LIM	390	-150	-600 to 600	%	REAL	NOT
This diagnostic indicates the final actual negative (lower) torque limit including any user current limit or inverse time (power stack) current limit action.						

Functional Description

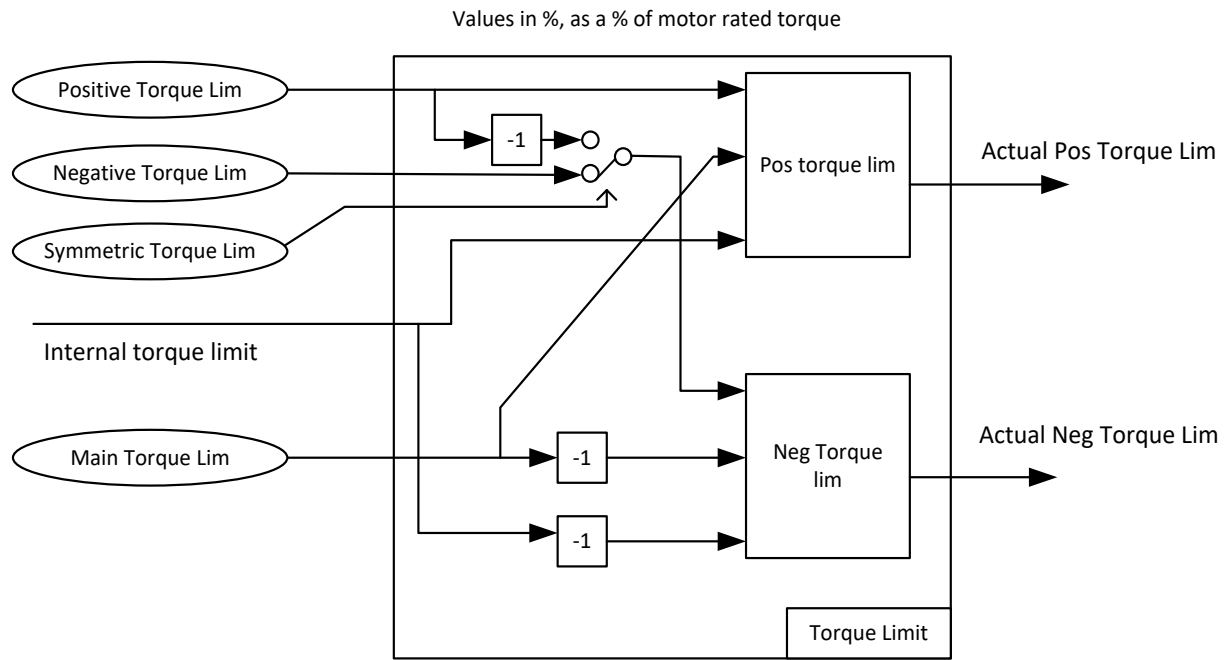

Tr Adaptation

Overview

This value is measured at autotune, but it will change as the motor temperature changes. The purpose of this block is to track the changing value of the rotor time constant, and to use all available feedback information to make the best possible estimate of its actual value at any given time.

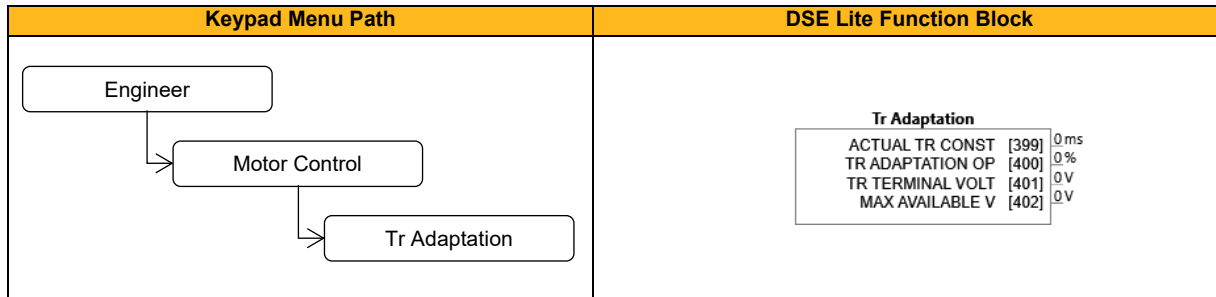

Function Block Outputs

Parameter Name	No.	Default Value	Range	Units	Type	Writable
ACTUAL TR CONST	399	1	1 to 100000	ms	REAL	NOT
This diagnostic shows the actual value of rotor time constant used by the motor control. This value is the nominal value stored in the Induction Motor Data, modified by this module to give a value as close as possible to the real value.						
TR ADAPTATION OP	400	1	1 to 500	%	REAL	NOT
The output of this module, which modifies the rotor time constant used for the motor control in order to correctly flux the motor when under load.						
TR TERMINAL VOLT	401	0	0 to 1000	V	REAL	NOT
Terminal volts demanded by the internal control loop.						
MAX AVAILABLE V	402	0	0 to 10000	V	REAL	NOT
This is the maximum motor terminal volts that can be achieved given the measured dc link volts.						

Trip History

Overview

Record of the last ten trips that caused the drive to stop.

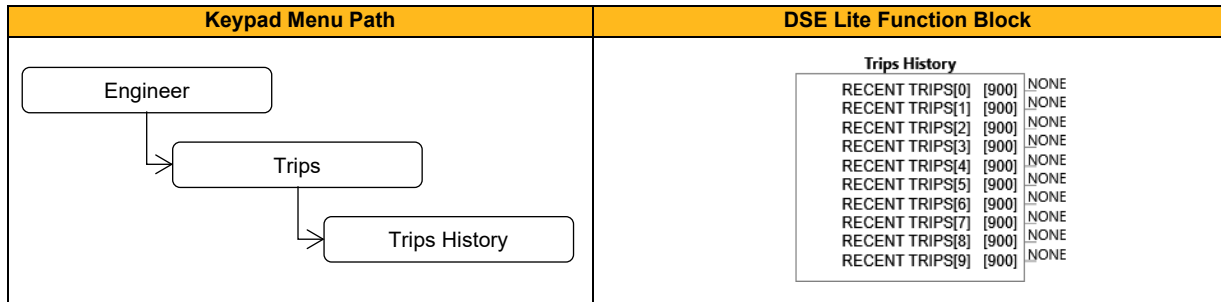

Function Block Outputs

Parameter Name	No.	Default Value	Range	Units	Type	Writable
RECENT TRIPS[0]... RECENT TRIPS[9]...	900	0: None	0: None 1: 01 Over Voltage 2: 02 Under Voltage 3: 03 Stack Over I 4: 04 Over Current 5: 05 Current Lim 6: 06 Motor Stall 7: 07 Inverse Time 8: 08 Motor I2t 9: 09 Low Speed I 10: 10 Heatsink Temp 11: 11 Internal Temp 12: 12 Motor Temp 13: 13 Dynamic Brake 14: 14 Digout Load 15: 15 Anin 1 Over 16: 16 Anin 2 Over 17: 17 Contactor 18: 18 Phase Fail 19: 19 Output Phase 20: 20 Vdc Ripple 21: 21 Pwr Loss Stop 22: 22 Overspeed 23: 23 PMAC Speed 24: N/A 25: 25 Speed Error 26: N/A 27: 27 Command Loss 28: 28 Comms Break 29: 29 Base Modbus 30: 30 Fieldbus 31: 31 STO Active 32: 32 External Trip 33: 33 A1 34: 34 A2 35: 35 A3 36: 36 A4 37: 37 CPU Loading		ENUM	NOT

The Recent Trips array is a record of the last 10 faults that caused the drive to disable the stack. Each entry has the same format as the First Trip parameter 880. The most recent fault is the first entry in the array, (Recent Trips[0]).

Trip Status

Overview

The drive supports advanced and flexible trip logic to support monitoring of the drive itself, the motor and the load. This function block provides a view of the current trip condition(s) and allows some trips to be disabled.

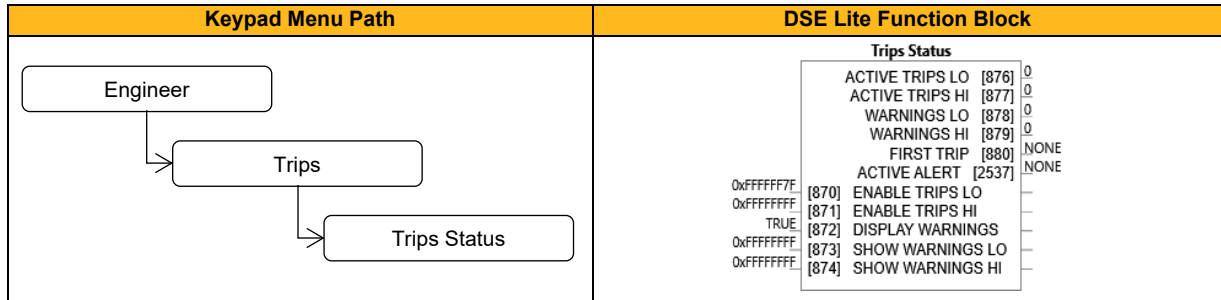

Function Block Inputs

Parameter Name	No.	Default Value	Range	Units	Type	Writable
ENABLE TRIPS LO	870	0xFFFFFFFF	0: 01 Over Voltage 1: 02 Under Voltage 2: 03 Stack Over I 3: 04 Over Current 4: 05 Current Lim 5: 06 Motor Stall 6: 07 Inverse Time 7: 08 Motor I2t 8: 09 Low Speed I 9: 10 Heatsink Temp 10: 11 Internal Temp 11: 12 Motor Temp 12: 13 Dynamic Brake 13: 14 Digout Load 14: 15 Anin 1 Over 15: 16 Anin 2 Over 16: 17 Contactor 17: 18 Phase Fail 18: 19 Output Phase 19: 20 Vdc Ripple 20: 21 Pwr Loss Stop 21: 22 Overspeed 22: 23 PMAC Speed 23: N/A 24: 25 Speed Error 25: N/A 26: 27 Command Loss 27: 28 Comms Break 28: 29 Base Modbus 29: 30 Fieldbus 30: 31 STO Active 31: 32 External Trip		DWORD	ALWAYS
A 32-bit word that can be used to enable, (or disable), individual trips. Note that 13 (Dynamic Brake) and 24 (Speed sensor Fault) are warning signals only. The drive will not trip due to either of these events.						
ENABLE TRIPS HI	871	0xFFFFFFFF	0: 33 A1 1: 34 A2 2: 35 A3 3: 36 A4 4: 37 CPU Loading		DWORD	ALWAYS
A 32-bit word that can be used to enable, (or disable), individual trips. Note that 38 (Track Error p), 39 (Track Error q) and 41 (p max) are warning signals only. The drive will not trip due to these events.						

DISPLAY WARNINGS	872	TRUE			BOOL	ALWAYS
When FALSE, warning messages are not shown on the HMI. When TRUE, warning messages are shown. Warning messages are not repeated once they have been acknowledged.						
SHOW WARNINGS LO	873	0xFFFFFFFF	Refer to Enable Trips Lo, P0870		DWORD	ALWAYS
A 32-bit word used to enable warnings on the HMI from trip sources that are close to a fault condition. Bit 0 corresponds to Trip ID 1, Over Voltage. For example, setting this parameter to FFFFFFFB will show all warnings in this range except for Motor Stall, trip ID 6. This parameter is ignored if parameter 0872 Display Warnings is FALSE						
SHOW WARNINGS HI	874	0xFFFFFFFF	Refer to Enable Trips Hi, P0871		DWORD	ALWAYS
A 32-bit word used to enable warnings on the keypad from trip sources that are close to a fault condition. Bit 0 corresponds to Trip ID 33. For example, setting this parameter to FFFBFFFF will show all warnings in this range except for CPU Usage, trip ID 37. This parameter is ignored if parameter 0872 Display Warnings is FALSE.						

Function Block Outputs

Parameter Name	No.	Default Value	Range	Units	Type	Writable
ACTIVE TRIPS LO	876	0: 0	See table for 'ENABLE TRIPS LO'		DWORD	NOT
A 32-bit word that indicates which trip sources are active. For example, the HEATSINK OVERTEMP may remain true for some time after the initial fault is reported. The Active value shows active trip sources even if the corresponding trip is not enabled in "Enabled 1-32".						
ACTIVE TRIPS HI	877	0: 0	See table for 'ENABLE TRIPS HI'		DWORD	NOT
A 32-bit word that indicates which trip sources are active. The Active value shows active trip sources even if the corresponding trip is not enabled in "Enabled 33-64".						
WARNINGS LO	878	0: 0	Refer to Active Trips Lo, P0876		DWORD	NOT
A 32-bit word that indicates trip sources that are close to a fault condition. For example, the heat sink fault monitoring firmware reports a HEATSINK OVERTEMP warning when the heat sink temperature gets close to the heat sink fault level. The Warnings value is not affected by the trip enable mask, "Enabled 1-32".						
WARNINGS HI	879	0: 0	Refer to Active Trips Hi, P0877		DWORD	NOT
A 32-bit word that indicates trip sources that are close to a fault condition. For example, the heat sink fault monitoring firmware reports a HEATSINK OVERTEMP warning when the heat sink temperature gets close to the heat sink fault level. The Warnings value is not affected by the trip enable mask, "Enabled 33-64".						
FIRST TRIP	880	0: None	See table for 'ENABLE TRIPS LO' and 'ENABLE TRIPS HI'		ENUM	NOT
Actual pending trip. When several trips have occurred, this parameter indicates the first one that was detected. Trip is signaled until it is reset.						
ACTIVE ALERT	2537	0: NONE	Refer to First Trip, P0880		ENUM	NOT
Actual pending alert. When alert is reset, this parameter is set to "None".						

Functional Description

If the drive trips, then the display immediately shows a message indicating the reason for the trip. The possible trip messages are given in the table below.

ID	Trip Name	Possible Reason for Trip	Criteria for Warning
1	01 Over Voltage	The drive internal dc link voltage is too high: <ul style="list-style-type: none"> • The supply voltage is too high • Trying to decelerate a large inertia load too quickly, DECEL TIME too short, • The brake resistor is open circuit <p>To help prevent this trip, enable the DC Link Volts Limit feature</p>	Internal dc link voltage has reached midway between the over voltage trip level and the dynamic braking resistor control voltage.
2	Stack Over I	The motor current exceeded the capabilities of the power stack. <ul style="list-style-type: none"> • Instantaneous overcurrent detected by the power stack. <p>Refer to OVERCURRENT in this table.</p>	Not applicable.
3	Under Voltage	DC link low trip: <ul style="list-style-type: none"> • Supply is too low/power down 	Internal dc link voltage has reached midway between the lowest expected instantaneous voltage and the undervoltage trip level.
4	Over Current	The motor current being drawn from the drive is too high: <ul style="list-style-type: none"> • Trying to accelerate a large inertia load too quickly; ACCEL TIME time too short • Trying to decelerate a large inertia load too quickly; DECEL TIME time too short • Application of shock load to motor • Short circuit between motor phases • Short circuit between motor phase and earth • Motor output cables too long or too many parallel motors connected to the drive • FIXED BOOST level set too high 	The over current trip uses a multiple-attempt strategy. The warning is triggered if two or more consecutive overcurrent events are encountered (whereas five consecutive events are required for a Trip to occur).
5	Current Lim	V/Hz mode only: If the current exceeds 200% of stack rated current for a period of 1 second, the drive will trip. This is caused by shock loads	Not applicable.
6	Motor Stall	The motor has stalled (not rotating) Drive in current limit >200 seconds: <ul style="list-style-type: none"> • Motor loading too great • FIXED BOOST level set too high 	The stall condition has been detected for more than half of the configured Stall Time.
7	Inverse Time	A prolonged overload condition, exceeding the Inverse Time allowance, has caused the trip: <ul style="list-style-type: none"> • Remove the overload condition 	An overload condition has exceeded one half of the Inverse Time allowance.
8	Motor I2t	Only for PMAC Motor: A prolonged load condition, exceeding the motor rated current, has caused the trip. The estimated motor load has reached a value of 105%	An overload condition has exceeded one half of the motor Inverse Time allowance.
9	Low Speed I	The motor is drawing too much current (>100%) at zero output frequency: <ul style="list-style-type: none"> • FIXED BOOST level set too high 	Not applicable.
10	Heatsink Temp	Drive heatsink temperature too high <ul style="list-style-type: none"> • The ambient air temperature is too high • Poor ventilation or spacing between drives • Check heatsink fan is rotating 	The drive heatsink has exceeded the warning temperature level (which is approx. 10°C below the trip temperature).
11	Internal Temp	Processor temperature or ambient temperature within the power stage too high <ul style="list-style-type: none"> • The ambient temperature in the drive is too high 	The drive processor temperature has exceeded the warning temperature level (which is approx. 10°C below the trip temperature).

ID	Trip Name	Possible Reason for Trip	Criteria for Warning
12	Motor Temp	The motor temperature is too high <ul style="list-style-type: none"> Excessive load Motor voltage rating incorrect FIXED BOOST level set too high Prolonged operation of the motor at low speed without forced cooling Break in motor thermistor connection No link fitted to thermistor terminals on drive 	The motor has been over temperature for 7.5 seconds.
13	Dynamic Brake	External dynamic brake resistor has been overloaded: <ul style="list-style-type: none"> Trying to decelerate a large inertia too quickly or too often Note that Dynamic Brake is a warning only. The drive will continue to operate and may eventually trip on 'Over Voltage' if action is not taken.	The power calculation for the external resistor has exceeded one half of the Brake Overrating allowance.
14	Digout Load	24V output voltage dropped by Digital output overload > 50mA: <ul style="list-style-type: none"> connect 24V user supply voltage Decrease output load 	Not applicable.
15	Anin 1 Over	Analog Input current > 30mA (Overload detected only in Current Mode)	Analog Input 1 overload detected once
16	Anin 2 Over	Analog Input current > 30mA (Overload detected only in Current Mode)	Analog Input 2 overload detected once
17	Contactor	DC Link failed to reach the undervoltage trip level within the contactor feedback time. <ul style="list-style-type: none"> The Line contactor failed to connect. Missing 3-phase line supply 	Not applicable.
18	Phase Fail	Indicates a missing input phase	Not applicable.
19	Output Phase	Motor Output Phase is missing. <ul style="list-style-type: none"> Motor Phase not connected. Current sensor missing or not correctly connected Motor Output phase only trips in V/Hz mode, if setpoint is >5Hz	Not applicable.
20	Vdc Ripple	The DC link ripple voltage is too high: <ul style="list-style-type: none"> Check for a missing input phase Repetitive start / stop or forward reverse action. 	The dc link ripple has exceeded 75% of the trip level.
21	Pwr Loss Stop	A Power Loss Ride Through sequence has occurred and either 0315 Pwrl Time Limit has been exceeded or the motor speed has reached a zero speed during the sequence.	Not applicable.
22	Overspeed	Overspeed: <ul style="list-style-type: none"> >150% base speed when in Sensorless Vector mode 	Not applicable.
23	PMAC Speed	Only for PMAC motor : When using the Start feature in Sensorless Vector Control, the real speed hasn't reached the speed setpoint after 5 seconds to move from open to closed loop control or to move from closed to open loop	Not applicable.
24	Speed Sensor	Not applicable.	Not applicable.
25	Speed Error	Difference between actual motor speed and the speed setpoint is greater than a threshold for a period of time.	Difference between actual motor speed and the speed setpoint has been greater than the trip threshold for more than half the trip delay time.
26	Feedback Err	Not applicable.	Not applicable.
27	Command Loss	Communication lost <ul style="list-style-type: none"> Connection to Remote Keypad lost, check cable 	Not applicable.
28	Comms Break	Lost option communications: <ul style="list-style-type: none"> A break in option communications has been detected. Refer to option communications manual.	Not applicable.

ID	Trip Name	Possible Reason for Trip	Criteria for Warning
29	Base Modbus	Lost Base Modbus communications: • A break in the Base Modbus communications has been detected	Not applicable.
30	Fieldbus	• A loss of connection to a fieldbus master has been detected, check cable to fieldbus master, check state of fieldbus master. Also EMC problems are possible	Not applicable.
31	STO Active	Attempt to run the motor with the Safe Torque Off active • Check the STO wiring. It may be necessary to power the drive off and on to completely clear this event. Note that this alarm may also appear if the STO inputs are connected to the 24V output of the inverter, and the maximum 50mA current allowance on the 24V output has been exceeded.	Not applicable.
32	External Trip	The external (application) trip input is high: • Refer to the application description to identify the source of the signal	Not applicable.
33	A1	Application trip 1. The application trips are controlled by the Application_Trips block in the configuration.	Application warning 1.
34	A2	Application trip 2	Application warning 2
35	A3	Application trip 3	Application warning 3
36	A4	Application trip 4	Application warning 4
37	CPU Loading	Combination of high switching frequency, high network traffic and complicated configuration. Reduce the Ethernet load or reduce the switching frequency.	Time-based warning issued at least 0.5s before the trip.
38	Track Error p	Difference between actual pressure and the pressure demand value is greater than the pressure error window threshold for a period of pressure error time. • Optimize controller adjustment • Increase P ERROR WINDOW and/or P ERROR TIME	Difference between actual pressure and demand pressure has been greater than the warning threshold for more than the warning delay time
39	Track Error q	Difference between actual volume flow and the volume flow demand value is greater than the volume flow error window threshold for a period of volume flow error time. • Optimize controller adjustment • Optimize speed limits • Increase Q ERROR WINDOW and/or Q ERROR TIME	Difference between actual volume flow and demand volume flow has been greater than the warning threshold for more than the warning delay time.
40	Comp Protect	The actual motor speed is lower than the minimal pump/motor speed for a period of component protection time. • Switch DCP off, if no pressure and/or volume flow is needed for a longer period of time • Increase COMP PROTECTION time	The actual motor speed has been lower than the pump/motor minimum speed threshold for more than the error delay time.
41	p max	The actual pressure is greater than the maximal pressure value.	The actual pressure is greater than the warning threshold, maximal pump short-term pressure.
42	Track Error Vel	Only for PMAC motor with feedback: Difference between actual motor speed and the speed setpoint is greater than 500rpm for more than 1 second.	Difference between actual motor speed and the speed setpoint has been greater than the trip threshold for more than the trip delay time.

Value Functions (Value Func 1 – 40)

Overview

The value function blocks can be configured to perform one of a number of functions upon a fixed number of inputs.

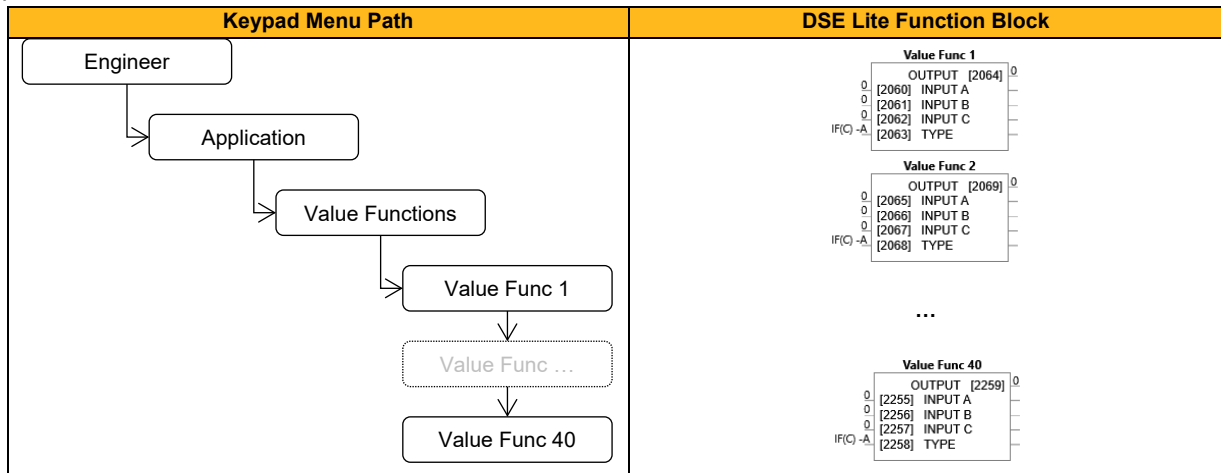

Function Block Inputs

Parameter Name	No.	Default Value	Range	Units	Type	Writable
INPUT A						
Value Func 1	2060	0	-2147483.5 ... 2147483.5		REAL	ALWAYS
Value Func 2	2065	0	-2147483.5 ... 2147483.5		REAL	ALWAYS
...	...					
Value Func 40	2255	0	-2147483.5 ... 2147483.5		REAL	ALWAYS
Input A for the selected function.						
INPUT B						
Value Func 1	2061	0	-2147483.5 ... 2147483.5		REAL	ALWAYS
Value Func 2	2066	0	-2147483.5 ... 2147483.5		REAL	ALWAYS
...	...					
Value Func 40	2256	0	-2147483.5 ... 2147483.5		REAL	ALWAYS
Input B for the selected function.						
INPUT C						
Value Func 1	2062	0	-2147483.5 ... 2147483.5		REAL	ALWAYS
Value Func 2	2067	0	-2147483.5 ... 2147483.5		REAL	ALWAYS
...	...					
Value Func 40	2257	0	-2147483.5 ... 2147483.5		REAL	ALWAYS
Input C for the selected function.						
TYPE						
Value Func 1	2063	0: IF(C) -A	0: IF(C) -A		ENUM	ALWAYS
Value Func 2	2068	0: IF(C) -A	1: ABS(A+B+C) 2: SWITCH(A,B)		ENUM	ALWAYS
...	...		3: (A*B)/C 4: A+B+C 5: A-B-C 6: B<=A<=C 7: A>B+/-C 8: A>=B 9: ABS(A)>B+/-C 10: ABS(A)>=B 11: A(1+B/100) 12: IF(C) HOLD(A) 13: BINARY DECODE 14: ON DELAY 15: OFF DELAY 16: TIMER 17: MINIMUM PULSE 18: PULSE TRAIN		ENUM	ALWAYS
Value Func 40	2258	0: IF(C) -A				

			19: WINDOW 20: UP/DWN COUNTER 21: (A*B)/C ROUND 22: WINDOW NO HYST 23: WIND A>=B, A<=C 24: A<=B 25: ((A*B)/100)+C 26: MIN(A,B,C) 27: MAX(A,B,C) 28: PROFILE SQRT 29: PROFILE LINEAR 30: PROFILE x^2 31: PROFILE x^3 32: PROFILE x^4 33: ON A<B, OFF A<C 34: (A+B) CLAMPED C 35: (A-B) CLAMPED C 36: (A*B) CLAMPED C 37: (A/B) CLAMPED C 38: A>=B:A; A<=C:0 39: (A * B) + C 40: A * (B + C) 41: A * (B - C) 42: A * (1 + B/C) 43: A * (1 + (B * C)) 44: MONOSTABLE HIGH 45: MONOSTABLE LOW 46: FILTER 47: (A-B)/(B-C) 48: 100*(A-B)/(B-C)			
Selects the function to be performed.						

Function Block Outputs

Parameter Name	No.	Default Value	Range	Units	Type	Writable
OUTPUT						
Value Func 1	2064	0	-2147483.5 ... 2147483.5		REAL	NOT
Value Func 2	2069	0	-2147483.5 ... 2147483.5		REAL	NOT
...	...					
Value Func 40	2259	0	-2147483.5 ... 2147483.5		REAL	NOT
The result of performing the selected function on the inputs.						

Functional Description

Output is generated from the inputs according to the **Type** selected. The **Output** is always limited to be within the range -2147483.5 to +2147483.5.

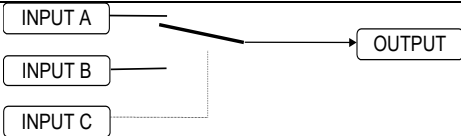
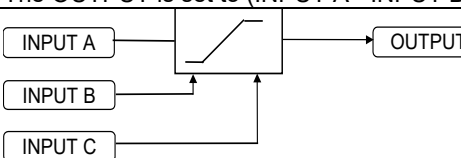
Operation	Description
IF(C) -A	If INPUT C is not zero the OUTPUT is minus INPUT A, otherwise the OUTPUT is the same as INPUT A.
ABS(A+B+C)	The OUTPUT is set to the absolute value of INPUT A + INPUT B + INPUT C.
SWITCH(A,B)	 <p>If INPUT C is zero the OUTPUT is set to INPUT A, otherwise the output is set to INPUT B</p>
(A*B)/C	The OUTPUT is set to (INPUT A * INPUT B) / (INPUT C). The algorithm compensates for the remainder term.
A+B+C	The OUTPUT is set to (INPUT A + INPUT B + INPUT C).
A-B-C	The OUTPUT is set to (INPUT A - INPUT B - INPUT C).
B <= A <= C	 <p>The OUTPUT is set to the value of INPUT A, limited to between a maximum value of INPUT C and a minimum value of INPUT B. If INPUT B is greater than INPUT C the output is undefined.</p>

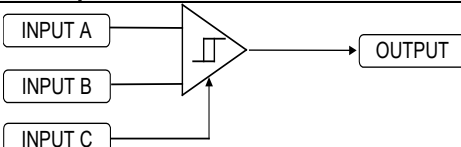
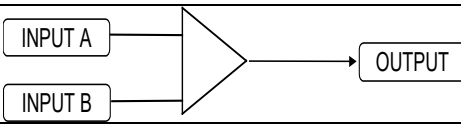
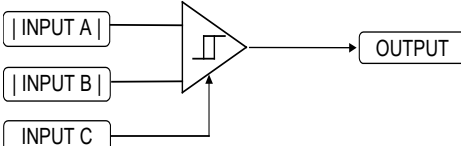
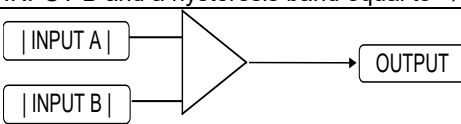
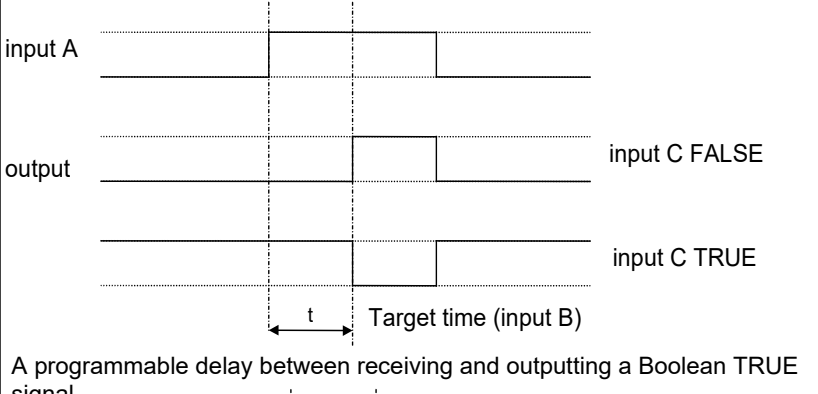
Operation	Description																																				
A>B+/-C	 <p>The OUTPUT is TRUE if INPUT A is greater than INPUT B + INPUT C. The OUTPUT is FALSE if INPUT A is less than INPUT B - INPUT C. Otherwise the OUTPUT is unchanged. In this way the block acts as a simple comparator with a comparison level of INPUT B and a hysteresis band equal to +/- INPUT C.</p>																																				
A>=B	 <p>The OUTPUT is TRUE if INPUT A is greater than or equal to INPUT B, otherwise the OUTPUT is FALSE.</p>																																				
ABS(A)>ABS(B)+/-C	 <p>The OUTPUT is TRUE if the magnitude of INPUT A is greater than or equal to the magnitude of INPUT B - INPUT C. The OUTPUT is FALSE if the magnitude of INPUT A is less than the magnitude of INPUT B - INPUT C. Otherwise the OUTPUT is unchanged. In this way the block acts as a magnitude comparator with a comparison level of INPUT B and a hysteresis band equal to +/- INPUT C.</p>																																				
ABS(A)>=ABS(B)	 <p>The OUTPUT is TRUE if the magnitude of INPUT A is greater than or equal to the magnitude of INPUT B, otherwise the OUTPUT is FALSE.</p>																																				
A(1+B)	The OUTPUT is set to $INPUT A + (INPUT A * INPUT B / 100.00)$.																																				
IF(C) HOLD A	<p>If INPUT C is zero, the OUTPUT is set to INPUT A, otherwise the OUTPUT is unchanged.</p> <p>On powering up the drive, the output will be pre-loaded with the last saved value of input B.</p>																																				
BINARY DECODE	<p>The OUTPUT is set according to which of the INPUTs are non-zero.</p> <table border="1" data-bbox="438 1131 917 1400"> <thead> <tr> <th>INPUT C</th> <th>INPUT B</th> <th>INPUT A</th> <th>OUTPUT</th> </tr> </thead> <tbody> <tr><td>0</td><td>0</td><td>0</td><td>0.00</td></tr> <tr><td>0</td><td>0</td><td>≠0</td><td>1.00</td></tr> <tr><td>0</td><td>≠0</td><td>0</td><td>2.00</td></tr> <tr><td>0</td><td>≠0</td><td>≠0</td><td>3.00</td></tr> <tr><td>≠0</td><td>0</td><td>0</td><td>4.00</td></tr> <tr><td>≠0</td><td>0</td><td>≠0</td><td>5.00</td></tr> <tr><td>≠0</td><td>≠0</td><td>0</td><td>6.00</td></tr> <tr><td>≠0</td><td>≠0</td><td>≠0</td><td>7.00</td></tr> </tbody> </table> <p>In the above table, ≠0 indicates that the corresponding input is not zero.</p>	INPUT C	INPUT B	INPUT A	OUTPUT	0	0	0	0.00	0	0	≠0	1.00	0	≠0	0	2.00	0	≠0	≠0	3.00	≠0	0	0	4.00	≠0	0	≠0	5.00	≠0	≠0	0	6.00	≠0	≠0	≠0	7.00
INPUT C	INPUT B	INPUT A	OUTPUT																																		
0	0	0	0.00																																		
0	0	≠0	1.00																																		
0	≠0	0	2.00																																		
0	≠0	≠0	3.00																																		
≠0	0	0	4.00																																		
≠0	0	≠0	5.00																																		
≠0	≠0	0	6.00																																		
≠0	≠0	≠0	7.00																																		
ON DELAY	 <p>A programmable delay between receiving and outputting a Boolean TRUE signal.</p> <p>INPUT A becoming TRUE starts the delay timer. INPUT B sets the duration of the delay in seconds (1 = 1 second). At the end of the duration, OUTPUT becomes TRUE unless INPUT A has reverted to FALSE. Setting INPUT C to TRUE (≠0) inverts the output.</p>																																				

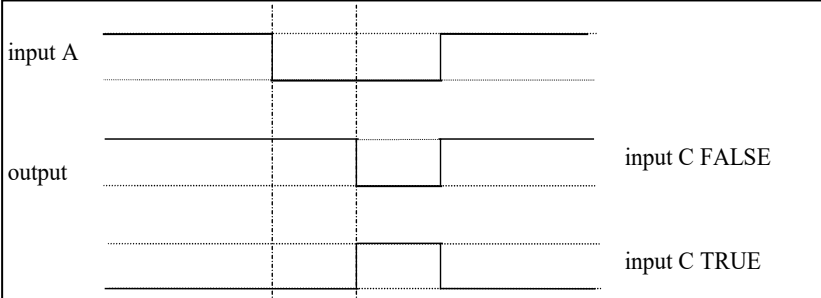
Operation	Description
OFF DELAY	 <p>A programmable delay between receiving and outputting a Boolean FALSE signal.</p> <p>INPUT A becoming FALSE starts the delay timer. INPUT B sets the duration of the delay in seconds (1 = 1 second). Setting INPUT C to TRUE ($\neq 0$) inverts the output. At the end of the duration, OUTPUT becomes FALSE unless INPUT A has reverted to TRUE.</p>

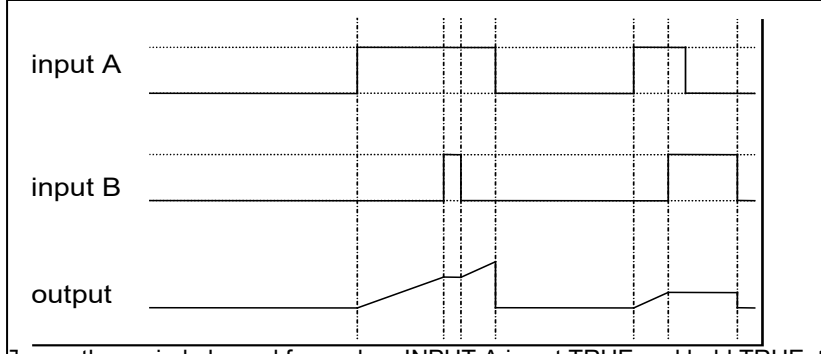
TIMER	 <p>Times the period elapsed from when INPUT A is set TRUE and held TRUE, to when INPUT B becomes TRUE.</p> <p>OUTPUT is the duration of the timer in seconds (1 = 1 second), starting from zero. If INPUT B is TRUE, the value for OUTPUT is held until INPUT B is released. If on release INPUT A is still TRUE, the timer will continue from the held value. Setting INPUT A and INPUT B to FALSE resets the timer. INPUT C is not used.</p>
-------	--

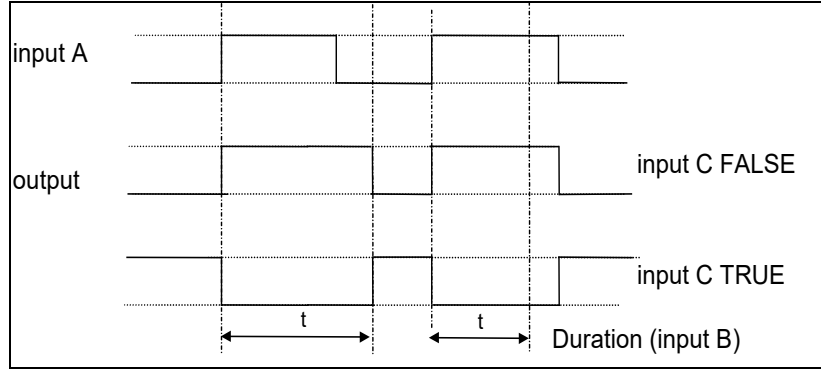
MINIMUM PULSE	 <p>Creates an output of adjustable minimum time when INPUT A is TRUE. (INPUT A is assumed to be a sequence of TRUE pulses and FALSE off periods.)</p> <p>INPUT B sets the length of the minimum pulse required in seconds (1 = 1 second). INPUT C inverts the output when TRUE. The duration of the pulse is <i>at least</i> the period set by INPUT B.</p>
---------------	--

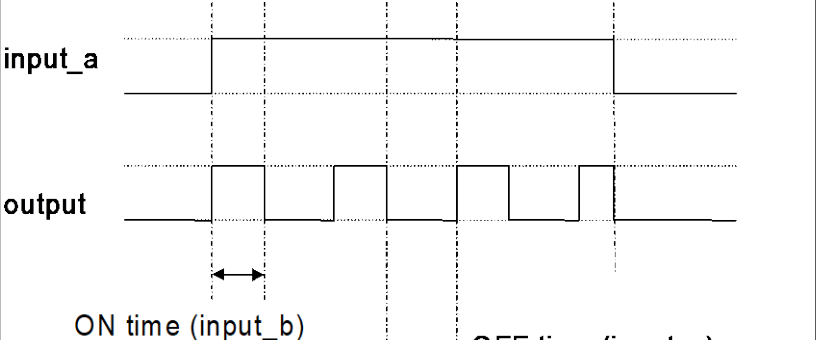
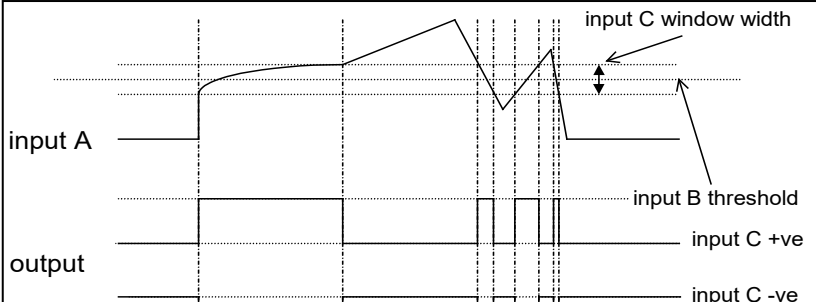
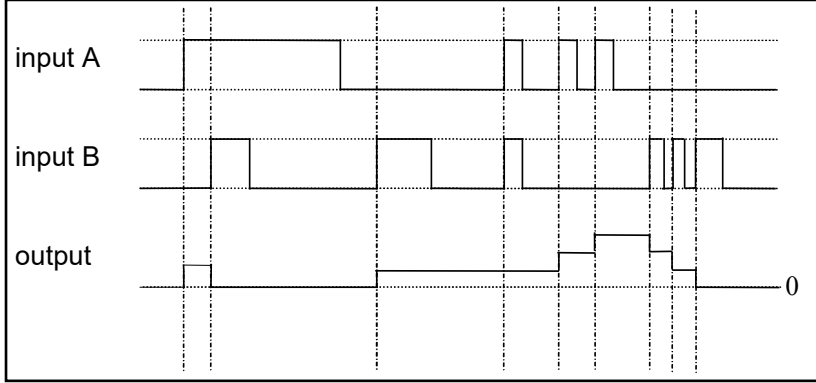
Operation	Description
PULSE TRAIN	 <p>Creates a pulsed FALSE / TRUE output of programmable frequency. INPUT A enables the pulse train when TRUE, disables when FALSE. INPUT B sets the length of the on part of the pulse in seconds (1 = 1 second). INPUT C sets the length of the off part of the pulse in seconds (1 = 1 second).</p>
WINDOW	 <p>This function outputs TRUE when INPUT A is within a programmable range, and FALSE otherwise. INPUT B sets the threshold of the window to be monitored. INPUT C defines the range of the window around the threshold. When the value of INPUT A is inside the window, the window expands by 0.01 to avoid flutter on output if noisy, i.e. if INPUT B = 5 and INPUT C = 4 then the range is 3 to 7, expanded to 2.5 to 7.5 when the value if INPUT A is inside the window. If INPUT C is set to zero, the output will only be TRUE if INPUT A is exactly equal to INPUT B (this is fulfilled in the default condition when inputs A, B & C are all zero) If INPUT C is set to a negative value, its absolute value defines the window range, and the output is inverted.</p>
UP/DOWN COUNTER	 <p>INPUT A provides a rising edge trigger to increment the output count by one. INPUT B provides a rising edge trigger to decrement the output count by one. INPUT C holds the output at zero. The output starts at zero. The output is limited at ± 300.00.</p>
$(A*B)/C$ ROUND	The OUTPUT is set to $(INPUT A * INPUT B) / (INPUT C)$. This is the same as $(A*B)/C$ (enumerated value 3) except that the result is rounded.
WINDOW NO HYST	This is the same as WINDOW (enumerated value 19) except that there is no hysteresis when inside the 'window'. Thus, from the diagram given in WINDOW, if INPUT B = 5 and INPUT C = 4 then the range is 3 to 7.
WIND $A \geq B, A \leq C$	This is the same as WINDOW (enumerated value 19) except that instead of setting hysteresis, the upper and lower limits are set independently. The lower limit is INPUT B, the upper limit is INPUT C. OUTPUT is True if $B \leq A \leq C$.
$A \leq B$	The OUTPUT is True if INPUT A is less than or equal to INPUT B, otherwise OUTPUT is False.

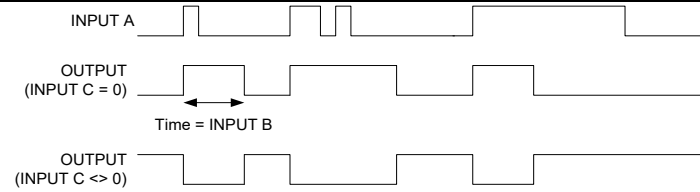
Operation	Description
$((A*B)/100)+C$	OUTPUT is set to $(INPUT A \times INPUT B)/100 + + INPUT C$.
MIN(A,B,C)	The OUTPUT is set to the minimum value of INPUT A, B and C.
MAX(A,B,C)	The OUTPUT is set to the maximum value of INPUT A, B and C.
PROFILE SQRT	OUTPUT = INPUT B + (INPUT C - INPUT B) x square root A.
PROFILE LINEAR	OUTPUT = INPUT B + (INPUT C - INPUT B) x INPUT A
PROFILE x^2	OUTPUT = INPUT B + (INPUT C - INPUT B) x $(INPUT A)^2$
PROFILE x^3	OUTPUT = INPUT B + (INPUT C - INPUT B) x $(INPUT A)^3$
PROFILE x^4	OUTPUT = INPUT B + (INPUT C - INPUT B) x $(INPUT A)^4$
ON A>B, OFF A<C	If A is greater than B, OUTPUT is 0.01. If A is less than C, OUTPUT is 0.00. Otherwise OUTPUT is unchanged.
(A+B) CLAMPED C	The output is the result of the arithmetic operation, clamped by the value of C. If C is greater than zero, the output if clamped to be less than C. If C is negative, the output is clamped to be greater than C. If C is zero the output is not clamped
(A-B) CLAMPED C	
(A*B) CLAMPED C	
(A/B) CLAMPED C	
A>=B:A, A<=C:0	If A is greater or equal to B, OUTPUT is set to A. If A is less than or equal to C, OUTPUT is 0.00. Otherwise OUTPUT is unchanged.
(A * B) + C	The output is the result of the arithmetic operation.
A * (B + C)	
A * (B - C)	
A * (1+B/C)	
A * (1+(B * C))	
MONOSTABLE HIGH	 <p>For each rising edge on input A, the output is active for a time defined by input B, (in seconds). If a subsequent rising edge is detected while the output is active, the end time of the output pulse is delayed as if it had been restarted. The output pulse is active high if input C is zero. If input C is not zero then the output pulse is active low and the idle state is high.</p>
MONOSTABLE LOW	<p>For each falling edge on input A, the output is active for a time defined by input B, (in seconds). If a subsequent falling edge is detected while the output is active, the end time of the output pulse is delayed as if it had been restarted.</p> <p>The output pulse is active high if input C is zero. If input C is not zero then the output pulse is active low and the idle state is high.</p>
FILTER	The output is the result of passing INPUT A through a first order filter with a time constant in seconds defined by INPUT B. Input C acts as a filter reset. When C is zero the filter is active. When C is non-zero the filter output is reset to be the same as input A.
(A-B)/(B-C)	The output is the result of the arithmetic operation.
100*(A-B)/(B-C)	

VDC Ripple

Overview

This function contains parameters and data associated to the VDC ripple detection and trip condition

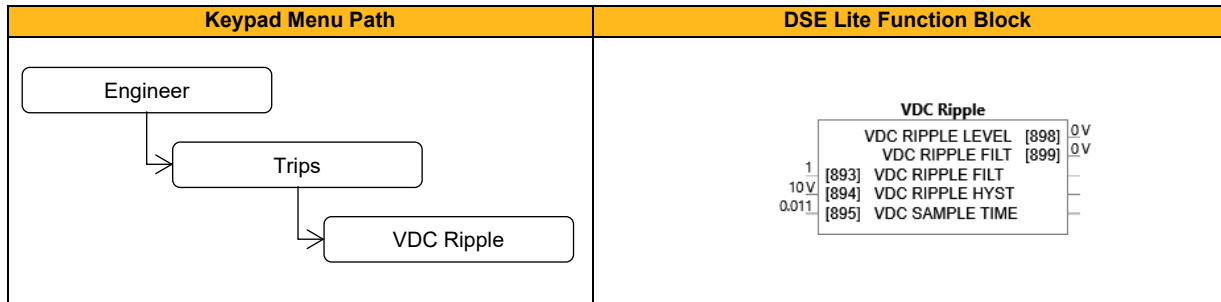

Function Block Inputs

Parameter Name	No.	Default Value	Range	Units	Type	Writable
VDC RIPPLE FILT	893	1	0.1 to 100		TIME	ALWAYS
VDC ripple filter time constant applied to the raw VDC ripple.						
VDC RIPPLE HYST	894	10	0 to 50	V	REAL	ALWAYS
Hysteresis on the VDC ripple level for trip condition.						
VDC SAMPLE TIME	895	0.011	0.003 to 0.1		TIME	ALWAYS
Sample time for peak-to-peak VDC voltage capture and ripple calculation.						

Function Block Outputs

Parameter Name	No.	Default Value	Range	Units	Type	Writable
VDC RIPPLE LEVEL	898	0	0 to 500	V	REAL	NOT
Actual raw VDC ripple level. Search time (=update rate) is P0895 'VDC sample time'						
VDC RIPPLE FILT	899	0	0 to 500	V	REAL	NOT
Filtered DC Link volts ripple. Update rate is P0895 'VDC sample time'						

Voltage Control

Overview

Designed for V/Hz motor Control Mode, this function allows the motor output volts to be controlled in the presence of dc link voltage variations. This is achieved by controlling the level of PWM modulation as a function of measured dc link volts. The DC link volts may vary either due to supply variations or regenerative braking by the motor.

Three control modes are available: None, Fixed and Automatic.

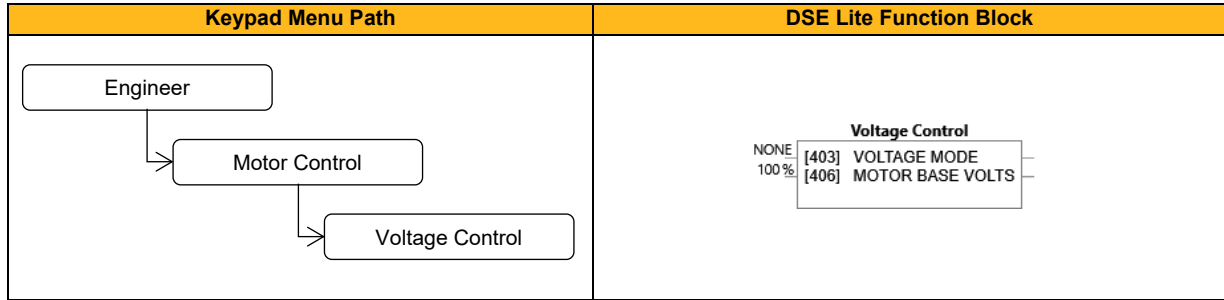

Function Block Inputs

Parameter Name	No.	Default Value	Range	Units	Type	Writable
VOLTAGE MODE	403	1: None	0: None 1: Fixed 2: Automatic		ENUM	STOPPED
Selection of voltage control mode, Fixed mode or Automatic mode may be used in case of dynamic motor operation including brake operation. Possible selections: None: Output voltage is a % of current DC bus (rectified supply) voltage. Motor voltage will directly follow dc link variations. Fixed: Output voltage is a % of given motor base voltage, this percentage is set by P0406 (Motor Base Volts). 100% equates to 95% of motor base voltage set in parameter 0223 to leave some headroom in case of dc link ripple or mains level variation. Demanded motor volts (if lower than the present dc link voltage) are maintained regardless of variations in the dc link. Automatic: Output voltage is in % of filtered DC bus (rectified supply) voltage. The filter time constant used is 200ms. Motor voltage will smoothly follow dc link variations as the voltage is allowed to rise smoothly as dc link volts vary. This allows the motor to be over-fluxed a little during deceleration, thereby increasing braking performance. Note: This filtered target voltage has a high limit of 1.1* rated motor voltage (400V drive) or 1.05* rated motor voltage (230V drive) to avoid too high voltage causing high currents being applied during regen operation. Voltage output is additionally scaled with P0406 "Motor Base Volts"						
MOTOR BASE VOLTS	406	100	0 to 115.47	%	REAL	ALWAYS
Scale of the motor output voltage in fixed mode. Reference voltage is motor base voltage P223. Please note that internally the result of (P406/100*P223) is limited to 264V for a 230V drive and 528V for a 400V drive. Fixed mode will only provide a fixed output voltage if the demanded voltage is lower than the present AC mains voltage.						

Web (HTTP) Server

Overview

Base Ethernet web server.

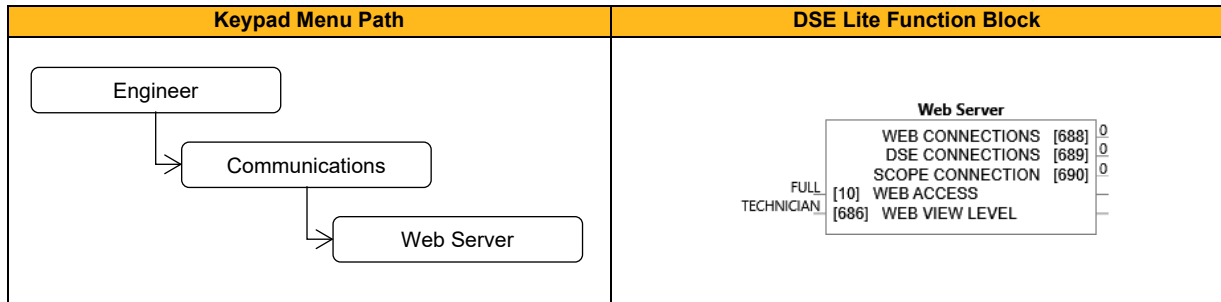

Function Block Inputs

Parameter Name	No.	Default Value	Range	Units	Type	Writable
WEB ACCESS	10	1: Full	0: Disabled 1: Limited 2: Full		ENUM	ALWAYS
The required access level of the base Ethernet web server. DISABLED: prevents any web access, LIMITED: prevents access to the parameters, FULL: allows full access, however authentication will be required if a password has been set.						
WEB VIEW LEVEL	686	1: Technician	0: Operator 1: Technician 2: Engineer		ENUM	ALWAYS
The required view level for the parameters web page on the base Ethernet web server.						

Function Block Outputs

Parameter Name	No.	Default Value	Range	Units	Type	Writable
WEB CONNECTIONS	688	0			USINT	NOT
Number of web connections in use.						
DSE CONNECTIONS	689	0			USINT	NOT
Number of DSE Lite connections.						
SCOPE CONNECTION	690	0			USINT	NOT
Number of scope connections.						

Functional Description

The inverter has a built-in web server. To access the web server the parameter **0010 Web Access** must be set to LIMITED (default) or FULL.

Zero Speed

Overview

This function block detects when the speed is at or close to zero. Hysteresis and Threshold are user-definable.

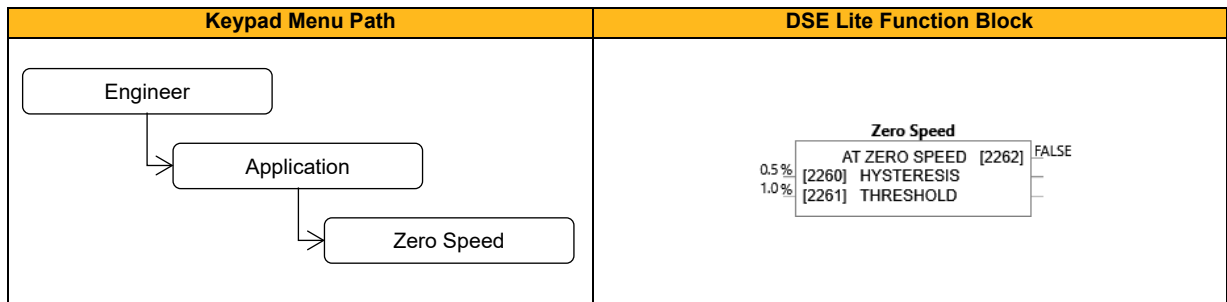

Function Block Inputs

Parameter Name	No.	Default Value	Range	Units	Type	Writable
HYSTERESIS	2260	0.5	0.0 to 300.0	%	REAL	ALWAYS
Hysteresis band of zero speed detection.						
THRESHOLD	2261	1.0	0.0 to 300.0	%	REAL	ALWAYS
Zero speed detection level.						

Function Block Outputs

Parameter Name	No.	Default Value	Range	Units	Type	Writable
AT ZERO SPEED	2262	FALSE			BOOL	NOT
TRUE when at zero speed as defined by Threshold and Hysteresis.						

Functional Description

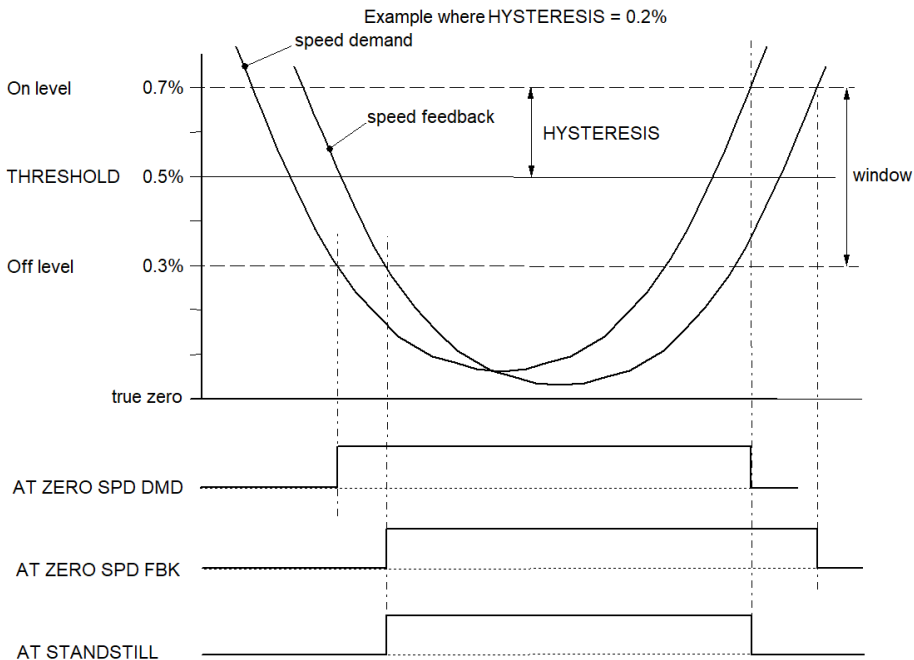

10 Inverter State Machine

10.1 DS402

The sequencing of the inverter is based on the DS402 / InverterCOM / IEC 61800-7 standard as used by most industrial fieldbuses. This allows it to be easily controlled and monitored by a PLC using the standards' Control and Status Words.

10.2 Sequencing State

The sequencing state of the unit is indicated by an enumerated value given by the **0517 Sequencing State** parameter.

Value	DS402 Sequence State	Description
0	NOT READY TO SWITCH ON	The Inverter is initialising or being configured.
1	SWITCH ON DISABLED	The Inverter will not accept a switch on command.
2	READY TO SWITCH ON	The Inverter will accept a switch on command.
3	SWITCHED ON	The Inverter will accept an Operation Enable (Run or Jog) command: <ul style="list-style-type: none"> - Power stage of the Inverter is ready to operate. - Voltage has not yet been applied to the motor terminals.
4	OPERATION ENABLED	Normal operational state of the Inverter. This state includes Running, Jogging, Stopping (Disabling Operation) and Shutting Down (Switching Off).
5	QUICKSTOP ACTIVE	Emergency Stop (Fast Stop) is active.
6	FAULT REACTION ACTIVE	The Inverter is processing a trip event.
7	FAULTED	The Inverter is tripped, awaiting a trip reset.

10.3 Sequencing Diagram

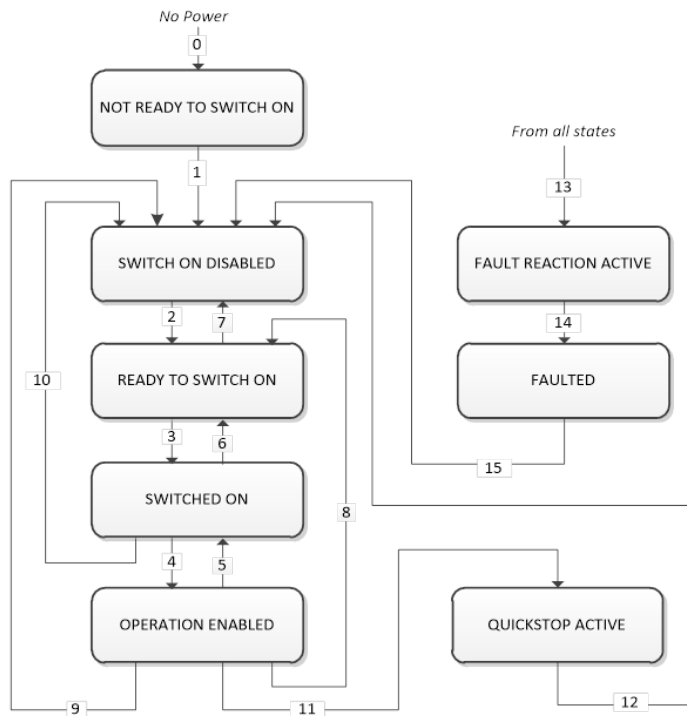

The OPERATION ENABLED state is the normal operation state of the Inverter. In this state the Reference Ramp is active, generating a Speed Demand. Sub-states and allowed transitions are shown below. Note – the RUNNING sub-state also includes JOGGING.

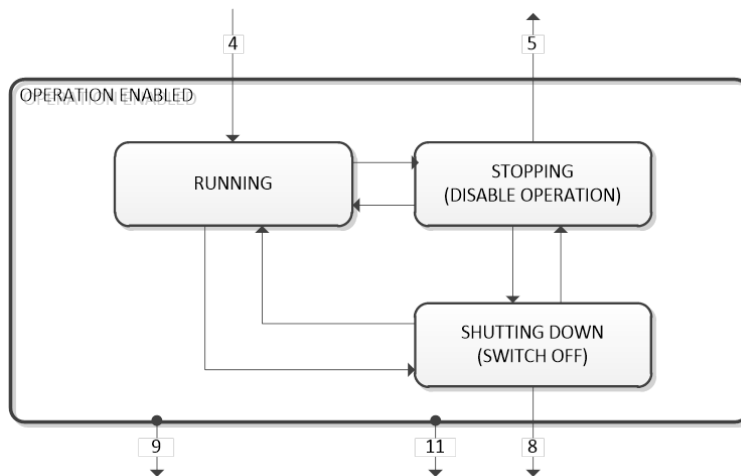

10.4 State Transitions

State transitions are caused by internal events in the Inverter or external commands via the Control Word. The transition numbers below relate to those on the Sequence Diagram.

Transition No.	Initial State	Resultant State	Description
0	No Power	NOT READY TO SWITCH ON	Power has been applied to the control electronics of the Inverter.
1	NOT READY TO SWITCH ON	SWITCH ON DISABLED	Automatic transition when initialisation has been completed and the application has been loaded.
2	SWITCH ON DISABLED	READY TO SWITCH ON	Shutdown command received from the control device or local signal.
3	READY TO SWITCH ON	SWITCHED ON	Switch On command received from the control device or local signal.
4	SWITCHED ON	OPERATION ENABLED	Enable Operation (Run Forward, Run Reverse or Jog) command received from the control device or local signal.
5	OPERATION ENABLED	SWITCHED ON	Disable Operation (Stop) command received from the control device or local signal and Disabling (Stopping) function completed.
6	SWITCHED ON	READY TO SWITCH ON	Shutdown command received from the control device or local signal.
7	READY TO SWITCH ON	SWITCH ON DISABLED	Quick Stop or Disable Voltage command received from the control device or local signal.
8	OPERATION ENABLED	READY TO SWITCH ON	Shutdown command received from the control device or local signal and Shutdown function completed.
9	OPERATION ENABLED	SWITCH ON DISABLED	Disable Voltage command received from the control device or local signal.
10	SWITCHED ON	SWITCH ON DISABLED	Disable Voltage or Quick Stop command received from the control device or local signal.
11	OPERATION ENABLED	QUICKSTOP ACTIVE	Quick Stop command received from control device or local signal.
12	QUICKSTOP ACTIVE	SWITCH ON DISABLED	Automatic transition when the Quick Stop function is completed or a Disable Voltage command is received.
13	Any State	FAULT REACTION ACTIVE	Fault (Trip) occurred.
14	FAULT REACTION ACTIVE	FAULTED	Automatic transition when the Fault Reaction function has completed, or a Disable Voltage command is received.
15	FAULTED	SWITCH ON DISABLED	Fault Reset command received from the control device or local signal, and there are no active faults.

10.5 Control Word

The commands that request a change in sequencer state are received via the Control Word. The current value is given by **0506 Control Word**. This is a read-only parameter which is updated from a source depending on the selected sequencing control channel. The sources available are COMMS, APP and LOCAL.

If COMMS is selected, the value will be taken from **0436 Comms Command**. This will normally be written to over the built-in Ethernet Modbus TCP/IP interface. The Not Quickstop, Enable Voltage and Switch On bits are ANDed with **0505 Remote Command**. The External Fault is ORed with the **0505 Remote Command**.

If APP is selected, the value will be taken from **0505 Remote Command**. This will normally be written to by the loaded application which is responsible for routing the control signals from Digital Input terminals.

If LOCAL is selected, the value will be written to by the MMI with the Not Quickstop, Enable Voltage, External Fault and Switch On bits from **0505 Remote Command**.

Bit	Name	Description
0	Switch On	OFF1 = 1 to switch on
1	Enable Voltage	OFF2 = 0 to coast stop
2	Not Quickstop	OFF3 = 0 to emergency stop
3	Enable Operation	1 = Run
4	Enable Ramp Output	=0 to set ramp output to zero
5	Enable Ramp	=0 to hold ramp
6	Enable Ramp Input	=0 to set ramp input to zero
7	Reset Fault	Reset trips on 0 to 1 transition
8	External Fault	1 = External (Application) trip active
9		unused
10	Use Comms Control	1 = Use 0436 Comms Control Word as the Control Word source for sequencing
11	Use Comms Reference	1 = Use 0458 Comms Reference as the Reference source
12	Use Jog Reference	1 = Run using 0480 Jog Setpoint when Enable Operation = 1
13	Reverse Direction	1 = Run in reverse direction when Enable Operation = 1
14	Auto Initialise	unused
15	Event Trigger OP	1 = Rising-edge of Enable Operation required for SWITCHED ON to OPERATION ENABLED transition

Example **0436 Comms Commands** (hexadecimal):

Control Word	Inverter Command
CC77	STOP
CC7F	RUN
CC7B	QUICKSTOP
CCF0	FAULT RESET

10.6 Status Word

The Status Word provides the detailed status of the sequencer. Regardless of the source of the Control Word, this is always available as **0507 Status Word**.

Bit	Name	Description
0	Ready to Switch On	Inverter initialised and not in Configuration mode.
1	Switched On	Inverter in SWITCHED ON or OPERATION ENABLED state.
2	Operation Enabled	Inverter Running (or stopping).
3	Faulted	Unacknowledged fault present.
4	Voltage Enabled	Line supply present
5	Quickstop Inactive	= 0 when reacting to a Quickstop request
6	Switch On Disabled	Inverter in SWITCH ON DISABLED state.
7		unused
8		unused
9	Control from Comms	Using 0436 Comms Control Word as the Control Word source
10		unused
11		unused
12	Jog Operation	Using Jog Reference or will use Jog Reference when Operation Enabled
13	Reverse Operation	Running backwards or will run backward when Operation Enabled
14	Reference from Comms	Using 0458 Comms Reference as the Reference source
15	Stopping	Operation Enable command removed or Quickstop active

11 Trips & Fault Finding

11.1 What Happens When a Trip Occurs?

When an inverter trip occurs, the inverter's power stage is immediately disabled causing the motor and load to coast to a stop. The trip is latched until action is taken to reset it. This ensures that trips due to transient conditions are captured and the Inverter is disabled, even when the original cause of the trip is no longer present.

11.2 Display/Keypad Indication

On the AC15 display, when the inverter is in a 'Tripped' state, a trip code will be displayed in the format "trxx", where xx is a number between 01 – 42 corresponding to a unique trip.

On the 6901 remote MMI, when the inverter is in a "Tripped" state, a message will be displayed in the format "xx yyy", where xx is a number between 01 – 42 that corresponds to a unique trip described by "yyy". In addition to the trip message, the "OK" status LED indicator will also flash.

The trip message(s) must be acknowledged by pressing the STOP key. The trip message may be cleared by pressing the E key.

11.3 Resetting a Trip Condition

All trips must be reset before the drive can be re-enabled. A trip can only be reset once the trip condition is no longer active, i.e. a trip due to a heatsink over-temperature will not reset until the temperature is below the trip level.

More than one trip can be active at any time. For example, it is possible for both the Heatsink Temp and the Overvoltage trips to be active. Alternatively, it is possible for the drive to trip due to an Overcurrent error and then for the Heatsink Trip to become active after the drive has stopped (this may occur due to the thermal time constant of the heatsink).

11.4 Trip and Warning Messages

If the drive trips, then the display immediately shows a message indicating the reason for the trip. The possible trip messages are given in the table below. Additionally, warnings will be displayed if a trip source is close to, but not yet in, a trip condition. This feature can be disabled by setting **0872 Display Warnings** to FALSE .

ID	Trip/Warning Name	Possible Reason for Trip	Criteria for Warning
1	Over Voltage	<p><i>The drive internal dc link voltage is too high:</i></p> <ul style="list-style-type: none"> • The supply voltage is too high • Trying to decelerate a large inertia load too quickly, DECEL TIME too short, • The brake resistor is open circuit <p>To help prevent this trip, enable the DC Link Volts Limit feature</p>	<p><i>Internal dc link voltage has reached midway between the over voltage trip level and the dynamic braking resistor control voltage.</i></p>
2	Stack Over I	<p><i>The motor current exceeded the capabilities of the power stack.</i></p> <ul style="list-style-type: none"> • Instantaneous overcurrent detected by the power stack. Refer to OVERCURRENT in this table. 	<p><i>Not applicable.</i></p>
3	Under Voltage	<p><i>DC link low trip:</i></p> <ul style="list-style-type: none"> • Supply is too low/power down 	<p><i>Internal dc link voltage has reached midway between the lowest expected instantaneous voltage and the undervoltage trip level.</i></p>
4	Over Current	<p><i>The motor current being drawn from the drive is too high:</i></p> <ul style="list-style-type: none"> • Trying to accelerate a large inertia load too quickly; ACCEL TIME time too short • Trying to decelerate a large inertia load too quickly; DECEL TIME time too short • Application of shock load to motor • Short circuit between motor phases • Short circuit between motor phase and earth • Motor output cables too long or too many parallel motors connected to the drive • FIXED BOOST level set too high 	<p><i>The over current trip uses a multiple-attempt strategy. The warning is triggered if two or more consecutive overcurrent events are encountered (whereas five consecutive events are required for a Trip to occur).</i></p>
5	Current Lim	<p>V/Hz mode only: If the current exceeds 200% of stack rated current for a period of 1 second, the drive will trip. This is caused by shock loads</p>	<p><i>Not applicable.</i></p>
6	Motor Stall	<p><i>The motor has stalled (not rotating) Drive in current limit >200 seconds:</i></p> <ul style="list-style-type: none"> • Motor loading too great • FIXED BOOST level set too high 	<p><i>The stall condition has been detected for more than half of the configured Stall Time.</i></p>
7	Inverse Time	<p><i>A prolonged overload condition, exceeding the Inverse Time allowance, has caused the trip:</i></p> <ul style="list-style-type: none"> • Remove the overload condition 	<p><i>An overload condition has exceeded one half of the Inverse Time allowance.</i></p>

ID	Trip/Warning Name	Possible Reason for Trip	Criteria for Warning
8	Motor I2t	Only for PMAC Motor: A prolonged load condition, exceeding the motor rated current, has caused the trip. The estimated motor load has reached a value of 105%	<i>An overload condition has exceeded one half of the motor Inverse Time allowance.</i>
9	Low Speed I	<i>The motor is drawing too much current (>100%) at zero output frequency:</i> <ul style="list-style-type: none"> • FIXED BOOST level set too high 	<i>Not applicable.</i>
10	Heatsink Temp	<i>Drive heatsink temperature too high</i> <ul style="list-style-type: none"> • The ambient air temperature is too high • Poor ventilation or spacing between drives • Check heatsink fan is rotating 	<i>The drive heatsink has exceeded the warning temperature level (which is approx. 10°C below the trip temperature).</i>
11	Internal Temp	<i>Processor temperature or ambient temperature within the power stage too high</i> <ul style="list-style-type: none"> • The ambient temperature in the drive is too high 	<i>The drive processor temperature has exceeded the warning temperature level (which is approx. 10°C below the trip temperature).</i>
12	Motor Temp	<i>The motor temperature is too high</i> <ul style="list-style-type: none"> • Excessive load • Motor voltage rating incorrect • FIXED BOOST level set too high • Prolonged operation of the motor at low speed without forced cooling • Break in motor thermistor connection • No link fitted to thermistor terminals on drive 	<i>The motor has been over temperature for 7.5 seconds.</i>
13	Dynamic Brake	<i>External dynamic brake resistor has been overloaded:</i> <ul style="list-style-type: none"> • Trying to decelerate a large inertia too quickly or too often 	<i>The power calculation for the external resistor has exceeded one half of the Brake Overrating allowance.</i>
14	Digout Load	<i>24V output voltage dropped by Digital output overload > 50mA:</i> <ul style="list-style-type: none"> • connect 24V user supply voltage • Decrease output load 	<i>Not applicable.</i>
15	Anin 1 Over	<i>Analog Input current > 30mA (Overload detected only in Current Mode)</i>	<i>Analog Input 1 overload detected once</i>
16	Anin 2 Over	<i>Analog Input current > 30mA (Overload detected only in Current Mode)</i>	<i>Analog Input 2 overload detected once</i>
17	Contacto	<i>DC Link failed to reach the undervoltage trip level within the contactor feedback time.</i> <ul style="list-style-type: none"> • The Line contactor failed to connect. • Missing 3-phase line supply 	<i>Not applicable.</i>
18	Phase Fail	<ul style="list-style-type: none"> • Indicates a missing input phase 	<i>Not applicable.</i>

ID	Trip/Warning Name	Possible Reason for Trip	Criteria for Warning
19	Output Phase	<p><i>Motor Output Phase is missing.</i></p> <ul style="list-style-type: none"> • Motor Phase not connected. • Current sensor missing or not correctly connected <p><i>Motor Output phase only trips in V/Hz mode, if setpoint is >5Hz</i></p>	<i>Not applicable.</i>
20	Vdc Ripple	<p><i>The DC link ripple voltage is too high:</i></p> <ul style="list-style-type: none"> • Check for a missing input phase • Repetitive start / stop or forward reverse action. 	<i>The dc link ripple has exceeded 75% of the trip level.</i>
21	Pwr Loss Stop	<p><i>A Power Loss Ride Through sequence has occurred and either 0315 Pwrl Time Limit has been exceeded or the motor speed has reached a zero speed during the sequence.</i></p>	<i>Not applicable.</i>
22	Overspeed	<p><i>Overspeed:</i></p> <ul style="list-style-type: none"> • >150% base speed when in Sensorless Vector mode 	<i>Not applicable.</i>
23	PMAC Speed	<p><i>Only for PMAC motor : When using the Start feature in Sensorless Vector Control, the real speed hasn't reached the speed setpoint after 5 seconds to move from open to closed loop control or to move from closed to open loop</i></p>	<i>Not applicable.</i>
24	Speed Sensor	<i>Not applicable.</i>	<i>Not applicable.</i>
25	Speed Error	<p><i>Difference between actual motor speed and the speed setpoint is greater than a threshold for a period of time.</i></p>	<p><i>Difference between actual motor speed and the speed setpoint has been greater than the trip threshold for more than half the trip delay time.</i></p>
26	Feedback Err	<i>Not applicable.</i>	<i>Not applicable.</i>
27	Command Loss	<p><i>Communication lost</i></p> <ul style="list-style-type: none"> • Connection to Remote Keypad lost, check cable 	<i>Not applicable.</i>
28	Comms Break	<p><i>Lost option communications:</i></p> <ul style="list-style-type: none"> • A break in option communications has been detected. Refer to option communications manual. 	<i>Not applicable.</i>
29	Base Modbus	<p><i>Lost Base Modbus communications:</i></p> <ul style="list-style-type: none"> • A break in the Base Modbus communications has been detected 	<i>Not applicable.</i>

ID	Trip/Warning Name	Possible Reason for Trip	Criteria for Warning
30	Fieldbus	<ul style="list-style-type: none"> A loss of connection to a fieldbus master has been detected, check cable to fieldbus master, check state of fieldbus master. Also EMC problems are possible 	<i>Not applicable.</i>
31	STO Active	<p><i>Attempt to run the motor with the Safe Torque Off active</i></p> <ul style="list-style-type: none"> Check the STO wiring. It may be necessary to power the drive off and on to completely clear this event. <p><i>Note that this alarm may also appear if the STO inputs are connected to the 24V output of the inverter, and the maximum 50mA current allowance on the 24V output has been exceeded.</i></p>	<i>Not applicable.</i>
32	External Trip	<p><i>The external (application) trip input is high:</i></p> <ul style="list-style-type: none"> Refer to the application description to identify the source of the signal 	<i>Not applicable.</i>
33	A1	<i>Application trip 1. The application trips are controlled by the Application_Trips block in the configuration.</i>	<i>Application warning 1.</i>
34	A2	<i>Application trip 2</i>	<i>Application warning 2</i>
35	A3	<i>Application trip 3</i>	<i>Application warning 3</i>
36	A4	<i>Application trip 4</i>	<i>Application warning 4</i>
37	CPU Loading	<p><i>Combination of high switching frequency, high network traffic and complicated configuration. Reduce the Ethernet load or reduce the switching frequency.</i></p>	Time based, warning issued at least 0.5s before the trip.

11.5 Alerts

Alert messages will be displayed upon certain actions being performed, or by errors in the inverter configuration or operation. The AC15 keypad will display ALxx where xx is the index of the alarm according to the table below. The 6901 keypad will display ***ALERT*** followed by a text description of the alert. An Alert can be cleared by pressing the E key.

Alert ID	Error / 6901 Display	AC15 Display
1	RUNTIME_ALERT	AL01
2	DEFAULTS_LOADED	AL02
3	FIRE_MODE	AL03
4	COAST_TO_STOP	AL04
5	ENABLE_VOLTAGE	AL05
6	QUICKSTOP_ACTIVE	AL06
7	OPERAT_ENABLED	AL07
8	DC_LINK_VOLTAGE	AL08
9	FEEDBACK_MISSING	AL09
10	MBUS_MAPPING_ERR	AL10
11	LOCAL_REMOTE1	AL11
12	LOCAL_REMOTE2	AL12
13	LOCAL_REMOTE3	AL13
14	FIRMWARE_UPGRADE	AL14
15	FIRE_MODE_ACTIVE	AL15
16	DEFAULTS_LOADED	AL16
17	CONFIG_FAULT	AL17
18	MAX_SPD_GT_ATN	AL18
18	PARAMETERS_SAVED	AL18
20	OPTC_MAPPING_ERR	AL20
21	EIP_MAPPING_ERR	AL21
22	PNIO_MAPPING_ERR	AL22
23	STD APP LOADED	AL23

11.6 Autotune Alerts

Problems which might occur during autotune process are also signalled by Alerts.

Alert ID	Alert Name / 6901 Display	Possible Reason For Alert
25	ALL_TESTS_DISABLED	Parameter 0038 ATN TEST DISABLE set to 31
26	IN_PROGRESS	Autotune running
27	LEAKAGE_L_TIMEOUT	Required current cannot be reached
28	MOTOR_STALLED_ERROR	Motor stall during autotune (not rotating)
29	MOTOR_TURNING_ERROR	Motor is not in standstill, when autotune is started
30	NEGATIVE_SLIP_FREQ	Negative slip frequency calculated
31	TR_TOO_LARGE	The calculated rotor time constant is greater than 10sec.
32	TR_TOO_SMALL	The calculated rotor time constant is less than 10ms.
33	MAX_SPEED_TOO_LOW	Max speed is set lower than nameplate rpm
34	SUPPLY_VOLTS_LOW	Available voltage supply is less than 70% of the rated motor volts.
35	NOT_AT_SPEED	Required motor speed is not reached after 10 seconds.
36	MAG_CURRENT_ERROR	The terminal volts have failed to reach the requested value after 40 seconds.
37	TORQUE_LIMIT_ERROR	Not implemented
38	KE_TOO_LARGE	The ke is greater than the trip level of the power stack.
39	KE_TOO_SMALL	The ke is less than 1v.
40	MRAS_PARA_CALC	MRAS parameters not found during autotune process

If one of these alerts occur, not all motor parameters may have been found during the autotune process, so please re-try the autotune.

12 Fire Mode

12.1 Introduction

Fire Mode is a special operating mode intended for use in critical situations where it is imperative for the motor to be kept running if at all possible. In such a situation, it may be acceptable to override the Inverter's normal protective functions.

An example of a critical situation may be a ventilation fan in a stairwell, where continued operation in the event of a fire may assist the safe evacuation of personnel.



Caution

When Fire Mode is active the Drive and Motor protection trips are disabled. The use of Fire Mode itself increases the risk of causing a fire by overloading the drive or motor, so it must only be used after assessing the risks.

When Fire Mode is enabled the drive firmware attempts to keep the drive running wherever possible. If the drive was running when Fire Mode was activated it will continue to run.

If the drive was stopped when Fire Mode was activated then the Fire Mode firmware will attempt to start it. While Fire Mode is enabled the majority of trips will be ignored, (possibly leading to damage to the drive, motor or attached equipment). If one of the remaining enabled trips does occur then the inverter will wait until the trip source has become inactive and will then restart the drive.

When Fire Mode is de-activated the drive will return to its previous sequencing mode. If the drive was running in Local mode the motor will be stopped. If the drive was running in remote mode the drive will continue running according to the relevant control word.

When Fire Mode is enabled the normal speed reference and start / stop control of the drive are modified.

12.2 Sequencing

Sequencing is the term given to controlling when the drive runs. When Fire Mode is enabled the normal sequencing control signals are over-ridden.

If the parameter **0440 Setpoint** is zero then setting parameter **0439 Activate** to TRUE will have no effect.

If the parameter **0440 Setpoint** is not zero then setting parameter **0439 Activate** to TRUE will activate Fire Mode. When Fire Mode is active the drive will run.

The only reasons that the drive may not run are:

- **0439 Activate** is changed back to FALSE
- **0440 Setpoint** is changed to zero
- The Coast Stop input is activated.
- The STO circuit is activated.
- An enabled trip source becomes active.
- A hardware fault.

The following trips are disabled / enabled in Fire Mode

ID	Trip Name	Trip Disabled	Drive Protection
1	OVER VOLTAGE		✓
2	UNDER VOLTAGE	✓	
3	STACK OVER I		✓
4	OVER CURRENT		✓
5	CURRENT LIMIT	✓	
6	MOTOR STALL	✓	
7	INVERSE TIME	✓	✓
8	MOTOR I2T	✓	
9	LOW SPEED I	✓	
10	HEATSINK OVERTEMP	✓	✓
11	AMBIENT OVERTEMP	✓	✓
12	MOTOR OVERTEMP	✓	
13	DYNAMIC BRAKE	✓	✓
14	DIGOUT LOAD	✓	✓
15	ANIN1 OVER	✓	✓
16	ANIN2 OVER	✓	✓
17	LINE CONTACTOR	✓	
18	PHASE FAIL	✓	
19	OUTPUT PHASE	✓	
20	VDC RIPPLE	✓	✓
21	POWER LOSS STOP	✓	
22	OVERSPEED	✓	
23	PMAC SPEED	✓	
24	SPEED SENSOR	✓	
25	SPEED ERROR	✓	
26	FEEDBACK ERR	✓	
27	COMMAND LOSS	✓	
28	COMMS BREAK	✓	
29	BASE MODBUS	✓	
30	FIELDBUS	✓	
31	STO ACTIVE	✓	
32	EXTERNAL TRIP	✓	
33	A1	✓	
34	A2	✓	
35	A3	✓	
36	A4	✓	
37	CPU LOAD	✓	

12.3 Reference

The Fire Mode Setpoint parameter is selected automatically whenever Fire Mode is Activated. The Setpoint is passed through the System Ramp



Caution

Fire Mode does not override the standard Ramp features. Specifically, **0477 Ramp Hold** can prevent the setpoint changing to the Fire Mode **Setpoint** value.

13 Fieldbuses

13.1 Modbus TCP/IP

The onboard Ethernet includes a Modbus TCP server. The Modbus registers are mapped to the inverter's parameters. Up to 3 simultaneous connections to Modbus clients are possible. TCP port 502 is used.

Making a connection to the Ethernet and setting an IP address on the inverter is described in Chapter 12 (Ethernet). If the Modbus TCP is used for process control it is recommended that a dedicated network be used with fixed IP addresses for the inverter.

To allow Modbus TCP connections to the inverter, the parameter **0656 Maximum Connections** must be set to a value greater than zero.

Modbus Register Mapping Summary

The inverter parameters are mapped to the Holding Registers and Input Registers, either as a fixed mapping or as a user-defined mapping. There is no mapping to Coils or Discrete Inputs.

Holding Register Address	Input Register Address	Description
0001 - 0256	0001 - 0256	User-defined mapping to the inverter parameter values.
0257 - 00528	0257 - 00528	Reserved area. Do not write into this register range.
0529 - onwards	0529 - onwards	Fixed mapping to the inverter parameter values.

Fixed Parameter Mapping

Each parameter number is mapped onto **two** consecutive Modbus registers regardless of the parameter data type. The relationship between the Holding Register or Input Register is given as:

$$\text{Register number} = (\text{parameter number} - 1) * 2 + 529$$

- If the parameter has a data type that uses one byte then it will occupy the low byte of the first register and the high byte will be zero, i.e. the register will not be sign extended.
- If the parameter has a data type that uses two bytes then it will occupy the first register.
- Unused register locations will read zero; writing to that location will have no effect.
- The word order of 32-bit parameters is determined by the inverter parameter **0657 High Word First**.
- Writable 32-bit parameters will only accept a change in value if both registers mapped to the parameter are written to in the same request.

Fixed Parameter Mapping - Arrays

Some parameters have multiple elements and are classified as parameter arrays. A parameter array has a parameter number that represents the whole of the array, but also has parameter numbers that represent each element of the array. An example is given below.

Array Example

A parameter array called Recent Trips has 10 elements.

Parameter Number	Parameter – Recent Trips
0900	Whole array
0901	index 0
...	...
0910	Index 9

If the parameter number of the whole array is 900, then the parameter number of the element index 0 of the array will be 901, the parameter number of the element index 1 will be 902, etc.

Note: String array parameters access their elements via parameter numbers that are calculated in a different way (see 9.2.2.5.2 Fixed Parameter Mapping - Strings).

Accessing the parameter arrays via the parameter number that represents the whole array is not recommended. This will access only the first four bytes (2 registers) of the array. The array should rather be accessed via its elements.

Fixed Parameter Mapping - Strings

Strings parameters have a parameter number that represents the whole string. This parameter number is mapped to two registers so limits access to the first four characters. Additional contiguous parameter numbers are set aside so that the whole string can be accessed: one additional parameter number for each four characters. The strings are packed into the registers low byte first.

String Example

A string parameter called Drive Name has a string length of 12 characters (plus the null terminator). This will have one parameter number allocated for the whole string (in this example 161) and 2 further parameter numbers for the string fragments (162,163).

If the value of the string is "0123456789AB":

Parameter Number	Parameter – Recent Trips	Register Number	Register Value	
			hi-byte	lo-byte
0161	Represent the Whole string "0123456789AB"	0849	'1'	'0'
		0850	'3'	'2'
0162	Fragment "0123"	0851	'5'	'4'
		0852	'7'	'6'
0163	Fragment "4567"	0853	'9'	'8'
		0854	'B'	'A'

Note: This is an example is not a real parameter.

As each inverter parameter maps to two registers, if the registers that represent the whole string are accessed then only the first four characters will appear. To access the whole string over Modbus use the registers that map to the parameter number of the whole array plus one, in this example 0162 (register 00851). A multiple read or write of registers will then provide access to the whole string

User-Defined Parameter Mapping

The inverter parameters may be mapped to the user-defined register area (00001 – 00256). This allows parameters to be grouped together so that they may be accessed through a single Modbus request.

To map parameters add the required parameter numbers to the user mapping table using parameter 1567 Modbus Mapping. The following applies:

- The mapping starts at register 00001.
- Any valid fixed or application parameter may be added excluding password parameters and parameter arrays - individual elements of the array may be added.
- Parameter strings may be added.
- The mapping ends on the first mapping entry of zero or when the mapping table is full.

Note: The mapping may be modified at any time. However, no Modbus requests should be made when the mapping is being modified to avoid indeterminate response data.

Unlike the fixed mapping, the user-defined parameter mapping will only use as many registers as necessary to accommodate the parameter. An example is given below:

Mapping Table	Parameter Name	Data Type	No. of Registers	Start Register	End Register
0	0435 Comms Command	WORD	1	0001	0001
1	0485 Comms Setpoint	REAL	2	0002	0003
2	656 Max Connections	USINT	1	0004	0004
3	0507 Status Word.	WORD	1	0005	0005
4	0103 Speed rpm	REAL	2	0006	0007
5	1000 Drive name	15-character STRING	8	0008	0015
6	0000				

The mapping table is continually checked for valid entries. The diagnostic parameter **0679 Mapping Valid** will be TRUE if all entries in the table are valid parameters. If the diagnostic parameter is FALSE, meaning there are invalid entries, then Modbus requests are still accepted but the invalid entries will be skipped over and will occupy no registers in the mapping.

The following applies to user-mapped parameters:

- If the parameter has a data type that uses one byte then it will occupy the low byte of the Modbus register and the high byte will be zero, i.e. the register will not be sign extended.
- The word order of 32-bit parameters is determined by the inverter parameter 0657 High Word First.
- Writable 32-bit parameters will only accept a change in value if both registers mapped to the parameter are written to in the same request.
- String parameters are packed into the registers low byte first.
- Writable string parameters will only accept a change if the first register is included in the request. If the string is not null terminated, then a null termination will be added automatically.

Password Protection

Write access to parameters via the fixed mapping registers may be restricted by setting the parameter 0661 **Modbus TCP Password**. Note that there is no restriction to parameters via the user-defined mapping registers.

When this password is set to a value other than zero, writing to parameters will only be possible when the password is unlocked. If the password is not unlocked then writes will be ignored.

To unlock the password write to the Modbus register **0518** the value set in the parameter 0661 Modbus TCP Password. Write access will be available until a subsequent write to the Modbus register 0518 of value 0000.

Note the following:

- A read of Modbus register 0518 will always respond with a value of 0000 regardless of the password being locked or unlocked.
- Locking and unlocking the password will apply to all Modbus connections.
- When all Modbus connections are closed, write access will returned to the locked state if a password is set.

Supported Modbus Functions

Four Modbus functions are supported:

Read Holding Registers (#3)

This function allows multiple Input registers to be read. Up to 125 registers may be read. As the Holding registers and Input registers map to the same inverter parameters this will return the same values as the Read Input Registers function.

Read Input Registers (#4)

This function allows multiple Holding registers to be read. Up to 125 registers may be read. As the Holding registers and Input registers map to the same inverter parameters this will return the same values as the Read Holding Registers function.

Write Single Register (#6)

This function allows a single Holding register to be written to. Note that this function may only be used on registers that map to 1-byte or 2-byte inverter parameters. An attempt to write to a register that maps to a 4-byte parameter will have no effect on the parameter.

Write Multiple Registers (#16)

This function allows a contiguous block of Holding registers to be written to. Up to 120 registers may be written. Note that when writing to registers that map to 4-byte inverter parameters both registers must be written to. Writing to one-half of a 4-byte parameter will have no effect on the parameter.

Modbus Exception Codes

Three Modbus exception codes are supported:

Illegal Function (01)

The Modbus function is not supported by the slave.

Illegal Data Address (02)

If the register data address contained in the Modbus request maps to an inverter parameter that is outside the range of parameter numbers then this exception will occur.

Illegal Data Value (03)

If the number of bytes or words contained in the Modbus request field is out of range then this exception will occur.

Process Active & Lost Communications Trip

Process Active Flag

The Process Active flag is represented by the inverter parameter 0681 Process Active. This parameter changes to TRUE on the first valid Modbus request.

If the parameter 0660 Modbus Timeout is set to a non-zero value then the Process Active parameter will subsequently change to FALSE if a Modbus request is not received within the timeout period.

Trip

If enabled, a break in the Modbus communications can be used to generate a trip. The 0681 Process Active parameter is used to generate the trip. If this parameter transitions from TRUE to FALSE then a trip will event will be generated.

To enable the base communications Modbus trip, the BASE MODBUS bit set in the parameter 0876 Active Trips Lo. The parameter 0658 Process Timeout must be set to a value other than zero.

For information on enabling trips see 11 Trips & Fault Finding.

Connection Timeout

The parameter 0680 Open Connections indicates the number of open connections to the inverter Modbus TCP server.

A connection receive timeout may be set using the parameter 0660 Modbus Conn Timeout. If this is set to a value other than zero, then the connection will be closed by the server if no data has been received within the timeout period. This is useful, for example, if the link between the server and client is lost, otherwise the connection may remain open indefinitely.

13.2 EtherNet/IP

The onboard Ethernet includes an EtherNet/IP adapter (slave/server) for AC15 Frame 2 and above. EtherNet/IP is not available on Frame 1 products.

Features

The following EtherNet/IP features are implemented:

- 2 Class 1 I/O connection supported
- 2 Class 3 connections supported
- 2 TCP connections supported
- Assembly instance element size of 1 word
- One input assembly instance of up to 128 bytes
- One output assembly instance of up to 128 bytes
- Input mapping up to 32 parameters
- Output mapping up to 32 parameters
- Requested Packet Interval (RPI) down to 2ms
- Explicit access of parameters (read and write) via the Vendor object
- PCCC and DF1 is not included

Identity

The EtherNet/IP adapter has the following identity:

- Vendor ID: 4 (Parker-Hannifin)
- Device Type: 0x002B (Generic)
- Product Code: 0xAC20 (Parker AC20 Drive)
- Product Name: "Parker AC15/AC20 Drive"

Inverter Configuration

To enable the EtherNet/IP device set the parameter **0791 Fieldbus** to ETHERNET IP. A change of Fieldbus can only be done in Pre-Operational state.

Note the EtherNet/IP device will only operate when the inverter is the Operational state.

The current state of the EtherNet/IP device is given by the parameter **0868 Fieldbus State**.

IP Settings

The IP settings are set up using the Ethernet parameters described Chapter 9.3 "Manual Ethernet Configuration". The IP settings of the inverter cannot be set via the PLC. The current IP settings are monitored using the parameters:

Parameter tag	Parameter name
0651	IP Address
0652	Subnet Mask
0653	Gateway Address

Parameter Mapping

The input and output assembly mappings of the inverter parameters are set in the parameters 0792 Input Mapping (PLC->inverter) and 0825 Output Mapping (inverter->PLC). Parameters created in the application may be added into the mapping. The mapping of each table ends on the first zero entry.

The total number of input and output bytes mapped depends on the number of parameters added to the mapping tables. All values are sent/read as 32 bit values (4 bytes). Thus, the number of input and output bytes is 4 times the number of parameters. Signed values are sign extended to 32 bits if the size is less than 4 bytes for outputs. The number of bytes used by each data type is summarized in the table.

AC15 Data Type	CIP type	Bytes
BOOL	BOOL	1
INT8	SINT	1
INT16	INT	2
INT32	DINT	4
UINT8	USINT	1
UINT16	UINT	2
UINT32	UDINT	4
REAL	REAL	4
ADDR	UDINT	4
DATE	UDINT	4
TOD	UDINT	4
DT	UDINT	4
DURATION	UDINT	4
BYTE	BYTE	1
WORD	WORD	2
DWORD	DWORD	4
PREF	UINT	2
STRING	SHORT_STRING	
ENUM	USINT	1
BIT16	WORD	2
BIT32	DWORD	4

For the input mapping each parameter must be read-writable. Read-only parameters, parameter arrays, configuration type parameters, string parameters, password parameters and reserved parameters are not permitted.

For the output mapping each parameter may be read-only or read-writable. Parameter arrays, string parameters and password parameters are not permitted.

If the input and output mappings have invalid entries then the parameter 0868 Fieldbus State will report ERROR and the inverter will not go into the Operational state. The parameter 0869 Fieldbus Diag can be used to determine which mapping table has an invalid entry.

Assembly Instances

The assembly instance numbers are:

Assembly Instance	Number
Input (T2O)	100
Output (O2T)	150
Input only	238
Listen Only	237

Electronic Data Sheet (EDS) File

The latest EtherNet/IP EDS file for the inverter may be downloaded from www.parker.com

Explicit Access of Parameters

Explicit access of the AC15 parameters is possible via the vendor specific object. Details of this are given in the section CIP Objects – Vendor Specific Object.

A parameter value may be read or written via Class 0x64, Attribute 0x5. The instance number is the same as the parameter number (PNO). The supported services are Get Attribute Single and Set Attribute Single. Strings parameters and parameter arrays are not supported!

Using a CoDeSys Based PLC

CoDeSys based PLCs can access parameters explicitly using the function blocks `Get_Attribute_Single` and `Set_Attribute_Single` from the library EtherNetIP Services.

Lost Communications Trip

A trip may be issued by the inverter on the loss of all Class1 connections of the EtherNet/IP adapter. To enable this, set Bit 30 - FIELDBUS in the parameter 0870 Enable Trips Lo.

Troubleshooting & Tips

The inverter fails to come out of configuration mode:

The input or output mapping tables have invalid parameter mappings. The parameter 0868 Fieldbus State will report ERROR. Check the parameter 0869 Fieldbus Diag to determine which mapping table has the incorrect mapping. Note the input mapping table may only contain read-writable parameters.

Failure to make a connection:

A connection between scanner and the adapter will not be made if:

- the input and output assembly data sizes of the scanner do not match the input and output mapping data sizes of the inverter
- the Requested Packet Interval (RPI) of the scanner is set to less than 1ms

Requested Packet Interval (RPI)

When mapping a large amount of data use an RPI of at least 10ms.

CIP Objects

The following CIP objects are supported:

- 0x01 Identity
- 0x02 Message Router
- 0x04 Assembly
- 0x06 Connection Manager
- 0x64 Vendor Specific
- 0xF5 TCP/IP Interface
- 0xF6 Ethernet Link

Class Attributes

Each object has the following class attributes.

Attribute	Description	Type	Access
1	Revision	UINT	Get
2	Maximum Instance	UINT	Get
3	Number of Instances	UINT	Get
4	Optional Attribute List	UINT	Get
5	Optional Service List	UINT	Get
6	Maximum Class Attribute	UINT	Get
7	Maximum Instance Attribute	UINT	Get
Supported Service Code		Service Name	
0Eh		Get_Attribute_Single	

Identity Object – 01h

Instance	Attribute	Description	Type	Value	Access
1	1	Vendor	UINT	0x0004 (Parker Hannifin)	Get
	2	Device Type	UINT	0x002B (Generic)	Get
	3	Product Code	UINT	0xAC20	Get
	4	Product Revision	UINT	0x0101 (minor/major)	Get
	5	Status	WORD	0	Get
	6	Serial Number	UDINT	Last 4 bytes of inverter MAC address	Get
	7	Product Name	SHORT STRING	“Parker AC15/AC20 Drive”	Get
Supported Service Code			Service Name		
01h			Get_Attribute_All		
05h			Reset - Type 0 and Type 1 Reset are supported ¹		
0Eh			Get_Attribute_Single		

Both Type 0 and Type 1 Reset will restart DHCP if enabled.

Message Router Object – 02h

Instance	Attribute	Description	Type	Value	Access
1	1	Object List	-	-	Get
	2	Total connections	UINT	-	Get
	3	Active connections	UINT	-	Get
Supported Service Code			Service Name		
01h			Get_Attribute_All		
0Eh			Get_Attribute_Single		

Assembly Object – 04h

Instance	Attribute	Description	Type	Value	Access
100	3	Input	USINT[128]	Parameter mapped values	Get
150	3	Output	USINT[128]	Parameter mapped values	Get/Set
Supported Service Code			Service Name		
0Eh			Get_Attribute_Single		
10h			Set_Attribute_Single		

Connection manager – 06h

There are no attributes for the Connection Manager.

TCP/IP Interface Object – F5h

Instance	Attribute	Description	Type	Value	Access	
1	1	Status	UINT	0	Interface Configuration not configured	Get
				1	Interface Configuration comes from DHCP	
				2	Interface Configuration comes from non-CIP settings	
	2	Configuration capability	DWORD	Bit 2 – DHCP capable (1) Bit 5 – non-CIP setting capable (1)	Get	
	3	Configuration control	DWORD	- If DHCP is disabled then writing a value of 0 is allowed - If DHCP is enabled then writing a value is 2 is allowed	Get/Set	
	4	Physical Link Object Structure of: Path Size Path	UINT Array of WORD	2 20F6h 2401h	Get	
	5	Interface Configuration Structure of: IP Address Network Address Gateway Address Name Server Name Server 2 Domain Server Size Domain Name	UDINT UDINT UDINT UDINT UINT STRING	Inverter IP address Inverter network mask Inverter gateway address 0 0 Returns the Domain Name if DHCP is enabled and the DHCP server has provided it.	Get	
6	Host Name Structure of: Size Host Name	UINT STRING	If DHCP is enabled and bound, returns the Host Name if the DHCP server has provided it, otherwise returns the default Host Name derived from the AC15 MAC address.	Get		
13	Encap TMO	UINT	Inactivity TMO seconds. On Type 1 Reset this value will revert to a value of 120.	Get/Set		
Supported Service Code			Service Name			
01h			Get_Attribute_All			
0Eh			Get_Attribute_Single			
10h			Set_Attribute_Single			

Ethernet Link Object – F6h

Instance	Attribute	Description	Type	Value	Access
1 2	1	Interface Speed	UDINT	10 or 100	Get
	2	Interface Flags	DWORD	Link status	Get
	3	Physical address	USINT[6]	MAC address	Get
	10	Interface label	SHORT STRING	“Port 1” or “Port 2”	Get
	11	Interface capability Structure of: Capability bits Speed/duplex array count	DWORD USINT	Auto-negotiation and MDIX supported (6) 0	Get
Supported Service Code			Service Name		
01h			Get_Attribute_All		
0Eh			Get_Attribute_Single		

Vendor Specific Object – 64h

The vendor specific object allows explicit access to AC15 parameters, including string parameters but excluding string arrays.

Instance	Attribute	Description	Type	Access
PNO	1	Parameter Name	SHORT STRING	Get
	2	CIP data type ¹	USINT	Get
	3	Number of parameter elements ²	USINT	Get
	4	Parameter qualifier Bit 0: Gettable Bit 1: Settable	BYTE	Get
	5	Parameter value	<i>Depends on parameter</i>	Get/Set
	6	Parameter min value	<i>Depends on parameter</i>	Get
	7	Parameter max value	<i>Depends on parameter</i>	Get
Supported Service Code			Service Name	
01h			Get_Attribute_All	
0Eh			Get_Attribute_Single	

Equivalent CIP data types – Volume 1 CIP Specification, Chapter 5A 14.2.1.2

For a standard parameter the number of elements will be 1, for a parameter array it will be the number elements in the array, and for a string parameter it will be the maximum number of characters.

APPENDIX A: Data types

The relationship between AC15 parameters and Fieldbus data types is given in the table below.

AC15 Parameter		CIP	
Data Type	Description	Data Type	Bytes
BOOL	Boolean	BOOL	1
SINT	Short integer	SINT	1
INT	Integer	INT	2
DINT	Double integer	DINT	4
USINT	Unsigned short integer	USINT	1
UINT	Unsigned integer	UINT	2
UDINT	Unsigned double integer	UDINT	4
REAL	Floating point	FLOAT	4
TIME	Duration	UDINT	4
DATE	Date	UDINT	4
TIME_OF_DAY	Time of day	UDINT	4
DATE_AND_TIME	Date and time of day	UDINT	4
STRING	String	SHORT_STRING**	<i>n</i>
BYTE	Bit string length 8	USINT	1
WORD	Bit string length 16	UINT	2
DWORD	Bit string length 32	UDINT	4

** SHORT_STRING consists of a single-byte length field followed by the actual character data.

Arrays

Some parameters have multiple elements and are classified as parameter arrays. A parameter array has a parameter number that accesses the *whole* of the array. It also has parameter numbers that represent each *element* of the array.

Array Example: A parameter array called **VHZ_USER_FREQ** has 11 elements.

Parameter Number	Parameter - VHZ_USER_FREQ
0145	whole array
0146	index 0
0147	index 1
...	...
0157	index 10

If the parameter number of the whole array is 0145, then the parameter number of the element index 0 of the array will be 0146, the parameter number of the element index 01 will be 0147, etc.

String

String parameters may be accessed via their parameter number. This is in the format of a SHORT_STRING. String arrays may not be accessed as a whole array but may be accessed via each element. Each element has its own parameter number.

APPENDIX B: Encoder Functions

Digital inputs 4 and 5 may be re-purposed as single-ended pulse encoder inputs. Take special care wiring the encoder to the drive due to the low level of the signals. All wiring to the drive should be made in screened cable. Use cable with an overall screen and a screen over each individual pair. The overall cable screen should be connected to the drive chassis.

The drive will operate with 5-24V encoders. Provide the correct supply for the encoder. Do not use the 10V or 24V supply from the drive.

The maximum input frequency of terminals DI4 and DI5 (ENCA and ENCB) is 100kHz

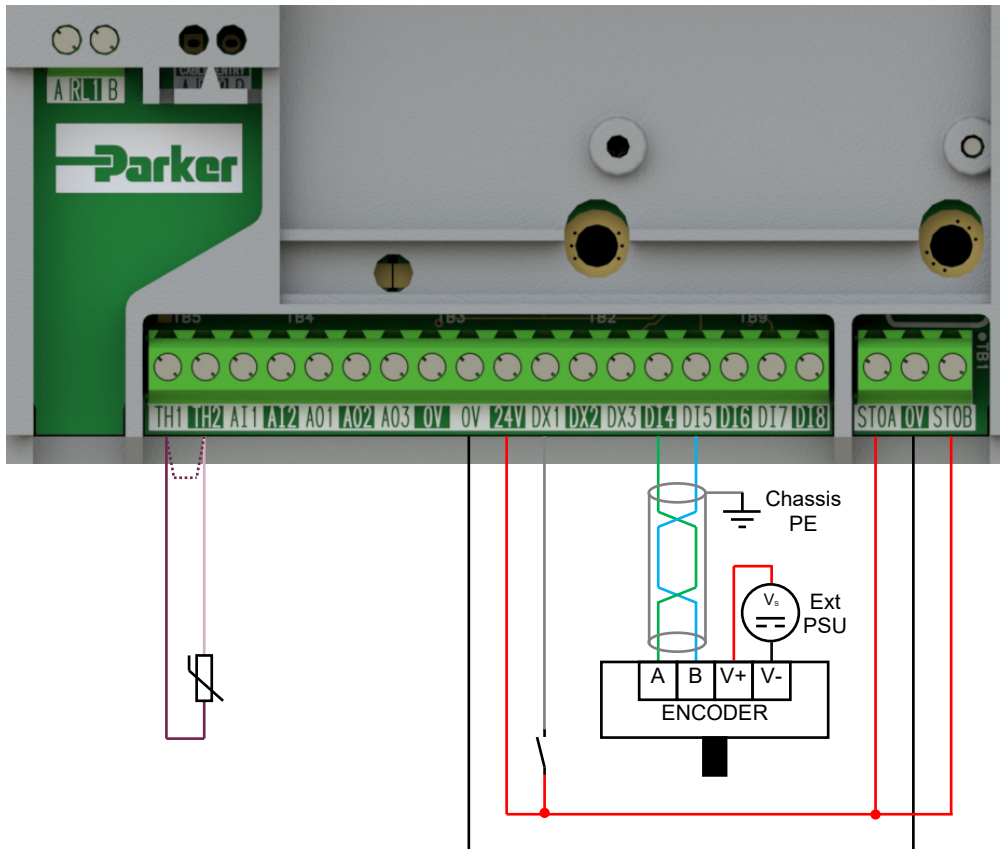

Speed follower example using a reference encoder

The minimum control connections required to run the drive with **'Remote'** operation, in a speed follower application are shown above.

The speed demand is generated from the encoder input in this application (i.e., for speed following).

The motor thermistor must be connected (or linked out), and the STO function needs to be disabled i.e., drive operational.

Note: It is recommended that the DSELite configuration tool is used to configure this application, as digital inputs 4 & 5 (DI4 & DI5) need to be disconnected from any other function in this mode of operation.

Configuration Setup:	
TH1	Motor Thermistor '+' connection (link to TH2 if no motor thermistor fitted)
TH2	Motor Thermistor '-' connection.
DX1	Run Forward: 24V digital input
DI4	Encoder Channel A Input (High Speed), 5-24V
DI5	Encoder Channel B Input (High Speed), 5-24V
STO	STO DISABLED (drive operational)

To enter the 'Encoder' information using a keypad, navigate to the 'Encoder' sub-menu:

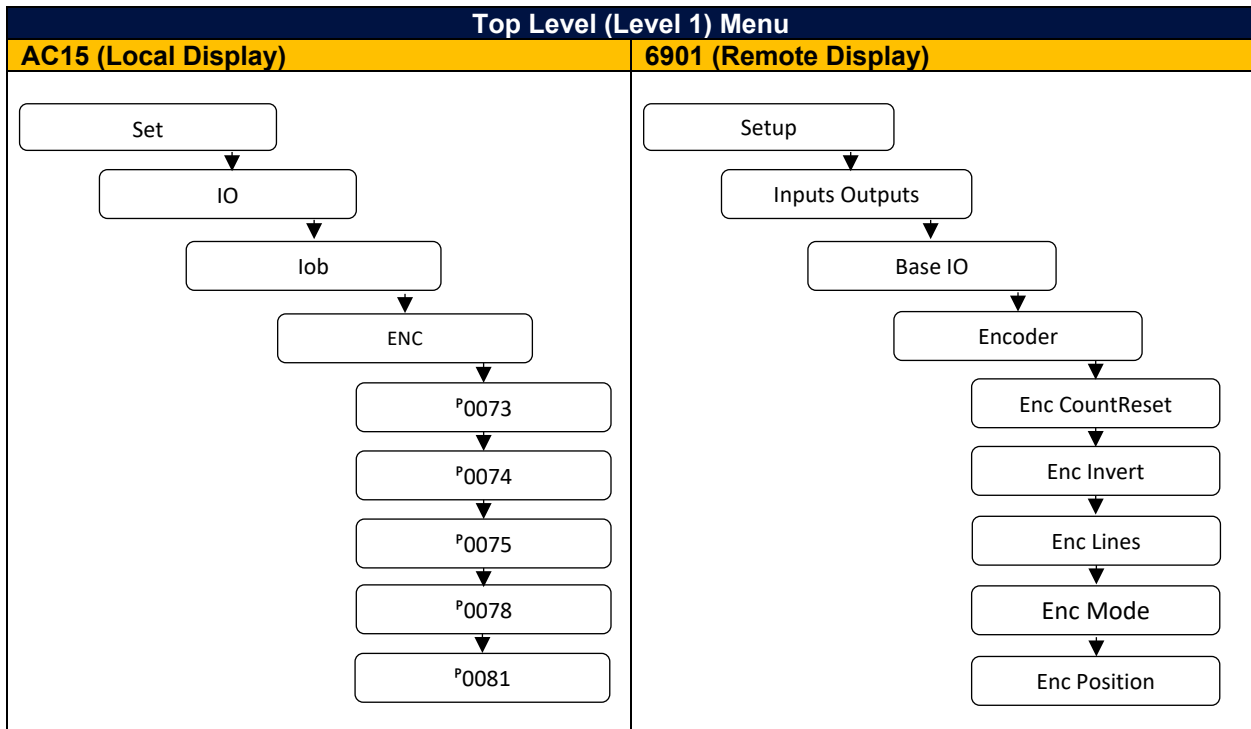

Parameter Name	No.	Default Value	Range	Units	Type	Writable
Enc CountReset	0073	0: FALSE	0: FALSE 1: TRUE		BOOL	ALWAYS
Enc Invert	0074	0: FALSE	0: FALSE 1: TRUE		BOOL	STOPPED
Enc Lines	0075	100	1 to 65535		UINT	STOPPED
Enc Mode	0078	0: Quadrature	0: Quadrature 1: Clock & Dir 2: Clock		ENUM	STOPPED
Enc Position	0081	0	-2147483648 to 2147483648		DINT	NOT

In the DSE Lite example below, parameter **0080 Enc Speed PCNT** gives an output of 100% when the measured encoder speed in rpm is equal to the parameter **0457 Max Speed**. It is therefore connected to a value function block to enable scaling between the source motor maximum speed, and the maximum speed of the motor being controlled. The result is then passed through the **Minimum Speed** function block to the **Remote Setpoint** parameter.

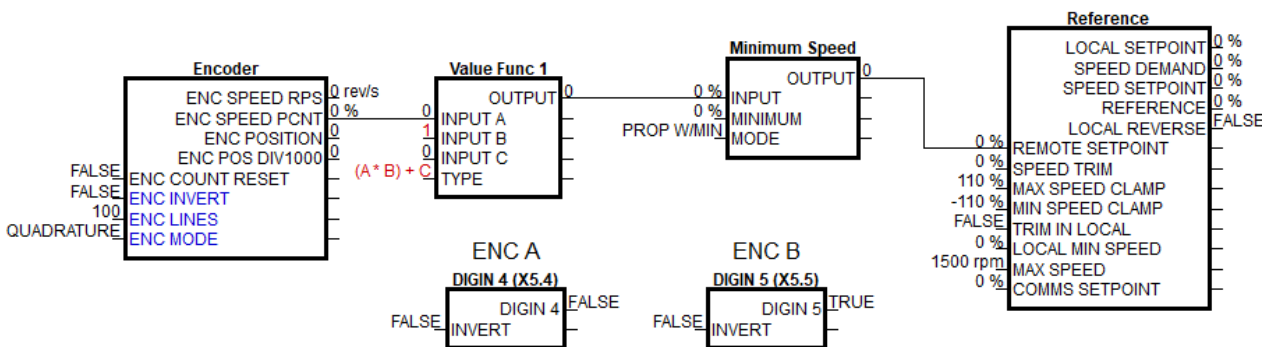

APPENDIX C: Parameters – Tag Number Order

Tag	Parameter	Function Block	Type	Range	View
1	Language	Customise Menus	ENUM		TECHNICIAN
2	GKP View Level	Keypad	ENUM		OPERATOR
3	KPad/DSE Password	Keypad	WORD		ENGINEER
10	Web Access	Web Server	ENUM		TECHNICIAN
30	Motor Type	Control Mode	ENUM		TECHNICIAN
31	Control Strategy	Control Mode	ENUM		TECHNICIAN
32	Control Type	Control Mode	ENUM		TECHNICIAN
34	Duty Selection	Control Mode	ENUM		TECHNICIAN
35	Atn Enable	Autotune	BOOL		TECHNICIAN
36	Atn Mode	Autotune	ENUM		TECHNICIAN
37	Atn Mag I Motor	Autotune	REAL	0.01 to 1000 A	TECHNICIAN
38	Atn Test Disable	Autotune	WORD		TECHNICIAN
39	Atn Ramp Time	Autotune	TIME	1 to 1000 s	TECHNICIAN
42	Atn PMAC Disable	Autotune	WORD		TECHNICIAN
43	Atn PMAC Ls Freq	Autotune	REAL	0 to 500 Hz	ENGINEER
44	Autotuned Speed	Autotune	REAL	-1 to 100000 rpm	TECHNICIAN
45	Braking Enable	Braking	BOOL		TECHNICIAN
46	Brake Power	Braking	REAL	0.1 to 510 kW	TECHNICIAN
47	Brake Overrating	Braking	REAL	1 to 40	TECHNICIAN
48	Brake Resistance	Braking	REAL	0.01 to 1000 Ohm	TECHNICIAN
50	Braking Active	Braking	BOOL		TECHNICIAN
54	Current Limit	Current Limit	REAL	0 to 600 %	TECHNICIAN
55	Regen. Limit VHz	Current Limit	BOOL		ENGINEER
56	Current Lim Out	Current Limit	REAL	0 to 600 %	TECHNICIAN
61	Predictive Term	Current Loop	BOOL		ENGINEER
69	VDC Lim Enable	DC Link Volt Lim	BOOL		TECHNICIAN
70	VDC Lim Level	DC Link Volt Lim	REAL	80 to 100 %	TECHNICIAN
71	VDC Lim Active	DC Link Volt Lim	BOOL		TECHNICIAN
72	VDC Lim Output	DC Link Volt Lim	REAL		ENGINEER
73	Enc CountReset	Encoder	BOOL		OPERATOR
74	Enc Invert	Encoder	BOOL		OPERATOR
75	Enc Lines	Encoder	UINT	1 to 65535	OPERATOR
78	Enc Mode	Encoder	ENUM		TECHNICIAN
79	Enc Speed rps	Encoder	REAL		OPERATOR
80	Enc Speed pcnt	Encoder	REAL		OPERATOR
81	Enc Position	Encoder	DINT		OPERATOR
91	Reset Meter	Energy Meter	BOOL		TECHNICIAN
92	Power kW	Energy Meter	REAL	0 to 1000000 kW	TECHNICIAN
93	Power HP	Energy Meter	REAL	0 to 1000000 hp	TECHNICIAN
94	Reactive Power	Energy Meter	REAL	0 to 1000000 kVAr	TECHNICIAN
95	Energy kWh	Energy Meter	REAL	0 to 10000000 kWh	TECHNICIAN
97	Power Factor Est	Energy Meter	REAL	0.0 to 1.0	TECHNICIAN
98	PF Angle Est	Energy Meter	REAL	0 to 90 deg	TECHNICIAN
99	Force Fan On	Fan Control	BOOL		ENGINEER
100	Advanced Mode	Fan Control	BOOL		ENGINEER

Tag	Parameter	Function Block	Type	Range	View
101	DC Link Trim	Feedbacks	REAL	-20 to 20 V	TECHNICIAN
102	DC Link Voltage	Feedbacks	REAL	0 to 1000 V	OPERATOR
103	Speed rpm	Feedbacks	REAL	-100000 to 100000 rpm	OPERATOR
104	Speed rps	Feedbacks	REAL	-1500 to 1500 rev/s	TECHNICIAN
105	Speed Percent	Feedbacks	REAL	-200 to 200 %	OPERATOR
106	DC Link Filtered	Feedbacks	REAL	0 to 1000 V	TECHNICIAN
107	id	Feedbacks	REAL	-600 to 600 %	TECHNICIAN
108	iq	Feedbacks	REAL	-600 to 600 %	TECHNICIAN
109	Torque	Feedbacks	REAL	-600 to 600 %	OPERATOR
110	Field Current	Feedbacks	REAL	-200 to 200 %	TECHNICIAN
111	Motor Cur Pcnt	Feedbacks	REAL	0 to 600 %	TECHNICIAN
112	Motor Current	Feedbacks	REAL	0 to 2000 A	OPERATOR
113	Stack Rated Cur	Feedbacks	REAL	0 to 2000 A	TECHNICIAN
114	Stack Current	Feedbacks	REAL	0 to 500 %	TECHNICIAN
115	Motor Terminal V	Feedbacks	REAL	0 to 1000 V	TECHNICIAN
116	CPU Temperature	Feedbacks	REAL	-25 to 200 °C	TECHNICIAN
117	Heatsink Temp	Feedbacks	REAL	-25 to 200 °C	TECHNICIAN
118	Elec Rotor Speed	Feedbacks	REAL	-1500 to 1500 Hz	OPERATOR
121	Filter Type	Torque Dmd Filtr	ENUM		TECHNICIAN
122	Cut Off Freq	Torque Dmd Filtr	REAL	20 to 6000 Hz	TECHNICIAN
123	Frequency 1	Torque Dmd Filtr	REAL	20 to 6000 Hz	TECHNICIAN
124	Frequency 2	Torque Dmd Filtr	REAL	20 to 6000 Hz	TECHNICIAN
125	Factor	Torque Dmd Filtr	REAL	0.10 to 1.00	TECHNICIAN
126	VHz Shape	Fluxing VHz	ENUM		TECHNICIAN
127	Fixed Boost	Fluxing VHz	REAL	0 to 25 %	TECHNICIAN
128	Auto Boost	Fluxing VHz	REAL	0 to 25 %	TECHNICIAN
130	Accel Boost	Fluxing VHz	REAL	0 to 25 %	TECHNICIAN
131	Energy Saving	Fluxing VHz	BOOL		TECHNICIAN
133	VHz User Freq	Fluxing VHz	REAL	0 to 100 %	ENGINEER
145	VHz User Volt	Fluxing VHz	REAL	0 to 100 %	ENGINEER
157	Vsd Demand	Fluxing VHz	REAL		TECHNICIAN
158	Vsq Demand	Fluxing VHz	REAL		TECHNICIAN
159	VHz Fly Enable	Flycatching	BOOL		TECHNICIAN
160	VC Fly Enable	Flycatching	BOOL		TECHNICIAN
161	Fly Start Mode	Flycatching	ENUM		TECHNICIAN
162	Fly Search Mode	Flycatching	ENUM		TECHNICIAN
163	Fly Search Volts	Flycatching	REAL	0 to 100 %	TECHNICIAN
164	Fly Search Boost	Flycatching	REAL	0 to 50 %	TECHNICIAN
165	Fly Search Time	Flycatching	TIME	0.1 to 60 s	TECHNICIAN
166	Fly Min Speed	Flycatching	REAL	0 to 500 Hz	TECHNICIAN
167	Fly Reflux Time	Flycatching	TIME	0.1 to 10 s	TECHNICIAN
175	Mag Current	Induction Motor	REAL	0.05 to 10000 A	ENGINEER
176	Rotor Time Const	Induction Motor	TIME	.005 to 100 s	ENGINEER
177	Leakage Induct	Induction Motor	REAL	0.001 to 1000 mH	ENGINEER
178	Stator Res	Induction Motor	REAL	0.0001 to 100 Ohm	ENGINEER
179	Rotor Res	Induction Motor	REAL	0.0001 to 100.00 Ohm	ENGINEER

Tag	Parameter	Function Block	Type	Range	View
180	Mutual Induct	Induction Motor	REAL	0.01 to 10000 mH	ENGINEER
182	IM Wiring	Induction Motor	BOOL		OPERATOR
203	Inj Deflux Time	Inj Braking	TIME	0.1 to 20.0 s	TECHNICIAN
204	Inj Max. Freq.	Inj Braking	REAL		ENGINEER
205	Inj Current Lim	Inj Braking	REAL	50 to 150 %	TECHNICIAN
206	DC Pulse	Inj Braking	TIME	.1 to 100 s	TECHNICIAN
207	Final DC Pulse	Inj Braking	TIME	.1 to 10 s	TECHNICIAN
208	DC Current Level	Inj Braking	REAL	0 to 25 %	TECHNICIAN
209	Inj Timeout	Inj Braking	TIME	0 to 600 s	TECHNICIAN
210	Inj Base Volts	Inj Braking	REAL	0.1 to 115.47 %	TECHNICIAN
211	Inv Time Delay	Motor Load	TIME	6 to 60 s	TECHNICIAN
212	100% Mot Current	Motor Load	REAL	0 to 10000 A	TECHNICIAN
213	Inv Time Overld	Motor Load	REAL	0 to 500 %	TECHNICIAN
214	Inv Time Warning	Motor Load	BOOL		TECHNICIAN
215	Inv Time Active	Motor Load	BOOL		TECHNICIAN
216	Inv Time Output	Motor Load	REAL	0 to 600 %	TECHNICIAN
217	Mot I2T TC	Motor Load	TIME	0 to 1000000	TECHNICIAN
218	Mot I2T Output	Motor Load	REAL	0 to 600 %	TECHNICIAN
219	Mot I2T Active	Motor Load	BOOL		OPERATOR
220	Mot I2T Warning	Motor Load	BOOL		TECHNICIAN
221	Mot I2T Enable	Motor Load	BOOL		TECHNICIAN
222	Rated Current	Motor Nameplate (IM)	REAL	.05 to 10000.0 A	TECHNICIAN
223	Base Voltage	Motor Nameplate (IM)	REAL	1 to 1000 V	TECHNICIAN
224	Base Frequency	Motor Nameplate (IM)	REAL	1 to 1000 Hz	TECHNICIAN
225	Motor Poles	Motor Nameplate (IM)	UINT	2 to 1000	TECHNICIAN
226	Nameplate Speed	Motor Nameplate (IM)	REAL	0 to 100000 rpm	TECHNICIAN
227	Motor Power	Motor Nameplate (IM)	REAL	0 to 3000 kW	TECHNICIAN
228	Power Factor	Motor Nameplate (IM)	REAL	0 to 1	TECHNICIAN
229	Auto Pole Pairs	Motor Nameplate (IM)	BOOL		TECHNICIAN
231	MSeq Main State	Motor Sequencer	ENUM		ENGINEER
232	MSeq Post Run	Motor Sequencer	ENUM		ENGINEER
233	MSeq Pre Run	Motor Sequencer	ENUM		ENGINEER
234	MSeq Deflx State	Motor Sequencer	ENUM		ENGINEER
254	MRAS Start Cur	MRAS (IM SVC)	REAL	0 to 100 %	TECHNICIAN
256	Switchover Enbl.	MRAS (IM SVC)	BOOL		TECHNICIAN
258	MRAS Speed Pcnt	MRAS (IM SVC)	REAL		TECHNICIAN
259	MRAS Speed RPM	MRAS (IM SVC)	REAL		TECHNICIAN
261	MRAS Field Freq	MRAS (IM SVC)	REAL		TECHNICIAN
262	MRAS Torque Pcnt	MRAS (IM SVC)	REAL		TECHNICIAN
263	MRAS Torque	MRAS (IM SVC)	REAL		TECHNICIAN
267	Stack Frequency	PatternGen (PWM)	REAL	1.0 to 16 kHz	ENGINEER
268	Random Pattern	PatternGen (PWM)	BOOL		ENGINEER
269	Deflux Delay	PatternGen (PWM)	TIME	0 to 60	ENGINEER
272	PWM CPU Overhead	PatternGen (PWM)	REAL	0 to 100 %	ENGINEER
279	PMAC Max Speed	PMAC Motor Data	REAL	1 to 100000.0 rpm	TECHNICIAN
280	PMAC Max Current	PMAC Motor Data	REAL	0.05 to 5000 A	TECHNICIAN

Tag	Parameter	Function Block	Type	Range	View
281	PMAC Rated Cur	PMAC Motor Data	REAL	0.05 to 5000 A	TECHNICIAN
282	PMAC Rated Torq	PMAC Motor Data	REAL	0.01 to 30000.0 Nm	TECHNICIAN
283	PMAC Motor Poles	PMAC Motor Data	UINT	2 to 400	TECHNICIAN
284	PMAC Back EMF Ke	PMAC Motor Data	REAL	0.1 to 30000 V	TECHNICIAN
285	PMAC Winding Res	PMAC Motor Data	REAL	0.001 to 500.0 Ohm	TECHNICIAN
286	PMAC Winding Ind	PMAC Motor Data	REAL	0.01 to 1000.0 mH	TECHNICIAN
287	PMAC Torque KT	PMAC Motor Data	REAL	0.01 to 10000.0 Nm/A	TECHNICIAN
288	PMAC Mot Inertia	PMAC Motor Data	REAL	0.0001 to 100.0 kgm ²	TECHNICIAN
289	PMAC Therm TC	PMAC Motor Data	TIME	1 to 10000	TECHNICIAN
290	PMAC Base Volt	PMAC Motor Data	REAL	1 to 1000 V	TECHNICIAN
291	PMAC Wiring	PMAC Motor Data	ENUM		TECHNICIAN
293	Phase Advance	PMAC Motor Adv	REAL	0 to 90 deg	ENGINEER
294	Max Phase	PMAC Motor Adv	REAL	0 to 90 deg	ENGINEER
295	PMAC Auto Values	PMAC SVC	BOOL		TECHNICIAN
296	PMAC LPF Speed	PMAC SVC	REAL	0 to 10000 Hz	TECHNICIAN
297	PMAC P Gain	PMAC SVC	REAL	0 to 10000	TECHNICIAN
298	PMAC I Gain	PMAC SVC	REAL	0 to 10000 Hz	TECHNICIAN
306	PMAC Start Mode	PMAC SVC	BOOL		TECHNICIAN
307	PMAC Start Time	PMAC SVC	TIME	0 to 1000	TECHNICIAN
308	PMAC Start Cur	PMAC SVC	REAL	0 to 600 %	TECHNICIAN
309	PMAC Start Speed	PMAC SVC	REAL	0 to 200 %	TECHNICIAN
310	Pwrl Enable	Power Loss	BOOL		TECHNICIAN
311	Pwrl Threshold	Power Loss	REAL	50 to 68 %	TECHNICIAN
312	Pwrl Ctrl Band	Power Loss	REAL	0 to 20 %	TECHNICIAN
313	Pwrl Accel Rate	Power Loss	REAL	1 to 500 Hz/s	TECHNICIAN
314	Pwrl Decel Rate	Power Loss	REAL	1 to 500 Hz/s	TECHNICIAN
315	Pwrl Time Limit	Power Loss	TIME	0 to 300	TECHNICIAN
316	Pwrl Active	Power Loss	BOOL		TECHNICIAN
317	Slew Rate Enable	Slew Rate	BOOL		TECHNICIAN
318	Slew Accel Limit	Slew Rate	REAL	1 to 1200 Hz/s	TECHNICIAN
319	Slew Decel Limit	Slew Rate	REAL	1 to 1200 Hz/s	TECHNICIAN
320	Slew Rate Output	Slew Rate	REAL		TECHNICIAN
321	SLP Enable	Slip Compensation	BOOL		TECHNICIAN
322	SLP Motoring Lim	Slip Compensation	REAL	0 to 600 rpm	TECHNICIAN
323	SLP Regen Lim	Slip Compensation	REAL	0 to 600 rpm	TECHNICIAN
326	SLP Output	Slip Compensation	REAL		TECHNICIAN
327	Direct IP Select	Spd Direct Input	ENUM		TECHNICIAN
328	Direct IP Ratio	Spd Direct Input	REAL	-10 to 10	TECHNICIAN
329	Direct IP Hi Lim	Spd Direct Input	REAL	-600 to 600 %	TECHNICIAN
330	Direct IP Lo Lim	Spd Direct Input	REAL	-600 to 600 %	TECHNICIAN
332	Speed Loop Auto	Speed Loop	BOOL		TECHNICIAN
333	Ratio JLoad:JMot	Speed Loop	REAL	0.1 to 100	TECHNICIAN
334	Loop Bandwidth	Speed Loop	ENUM		TECHNICIAN
335	Speed Prop gain	Speed Loop	REAL	0 to 3000	TECHNICIAN
336	Speed Int Time	Speed Loop	TIME	0.001 to 15	TECHNICIAN
337	Speed Int Defeat	Speed Loop	BOOL		TECHNICIAN

Tag	Parameter	Function Block	Type	Range	View
338	Speed Int Preset	Speed Loop	REAL	-600 to 600	TECHNICIAN
339	Spd Dmd Filter	Speed Loop	REAL	0 to 50 ms	TECHNICIAN
340	Spd Fbk Filter	Speed Loop	REAL	0 to 25 ms	TECHNICIAN
341	Aux Torq Dmd	Speed Loop	REAL	-600 to 600 %	TECHNICIAN
343	Adaptive Thres	Speed Loop	REAL	0 to 10 %	TECHNICIAN
344	Adaptive P gain	Speed Loop	REAL	0 to 300	TECHNICIAN
345	Speed Pos Lim	Speed Loop	REAL	-110 to 110 %	TECHNICIAN
346	Speed Neg Lim	Speed Loop	REAL	-110 to 110 %	TECHNICIAN
347	Torq Dmd Isolate	Speed Loop	BOOL		TECHNICIAN
348	Speed Limiter	Speed Loop	BOOL		TECHNICIAN
349	Total Demand RPM	Speed Loop	REAL	-100000 to 100000 rpm	TECHNICIAN
350	Total Demand %	Speed Loop	REAL	-200 to 200 %	TECHNICIAN
351	Speed Loop Error	Speed Loop	REAL	-600 to 600 %	TECHNICIAN
352	Speed PI Output	Speed Loop	REAL	-600 to 600 %	TECHNICIAN
353	Speed Limiter On	Speed Loop	BOOL		TECHNICIAN
354	STB Enable	Stabilisation	BOOL		TECHNICIAN
361	Aiming Point	Stack Inv Time	REAL	0 to 125.0 %	TECHNICIAN
362	Inv Time Up Rate	Stack Inv Time	TIME	0 to 120	ENGINEER
363	Inv Time Dn Rate	Stack Inv Time	TIME	0 to 120	ENGINEER
364	100% Stk Current	Stack Inv Time	REAL	0 to 10000 A	TECHNICIAN
365	Long Load Level	Stack Inv Time	REAL	0 to 200 %	TECHNICIAN
366	Long Load Time	Stack Inv Time	TIME	0 to 100000	TECHNICIAN
367	Short Load Level	Stack Inv Time	REAL	0 to 200 %	TECHNICIAN
368	Short Load Time	Stack Inv Time	TIME	0 to 10000	TECHNICIAN
369	Inv Time Output	Stack Inv Time	REAL	0 to 600 %	TECHNICIAN
370	Inv Time Warning	Stack Inv Time	BOOL		TECHNICIAN
371	Inv Time Active	Stack Inv Time	BOOL		TECHNICIAN
384	Pos Torque Lim	Torque Limit	REAL	-600 to 600 %	TECHNICIAN
385	Neg Torque Lim	Torque Limit	REAL	-600 to 600 %	TECHNICIAN
386	Main Torque Lim	Torque Limit	REAL	0 to 600 %	TECHNICIAN
387	Fast Stop T_Lim	Torque Limit	REAL	0 to 600 %	TECHNICIAN
388	Symmetric T_Lim	Torque Limit	BOOL		TECHNICIAN
389	Actual T_Lim Pos	Torque Limit	REAL	-600 to 600 %	TECHNICIAN
390	Actual T_Lim Neg	Torque Limit	REAL	-600 to 600 %	TECHNICIAN
399	Actual Tr Const	Tr Adaptation	REAL	1 to 100000 ms	ENGINEER
400	Tr Adaptation OP	Tr Adaptation	REAL	1 to 500 %	ENGINEER
401	Tr Terminal Volt	Tr Adaptation	REAL	0 to 1000 V	ENGINEER
402	Max Available V	Tr Adaptation	REAL	0 to 10000 V	ENGINEER
403	Voltage Mode	Voltage Control	ENUM		TECHNICIAN
406	Motor Base Volts	Voltage Control	REAL	0 to 115.47 %	TECHNICIAN
420	AR Enable	Auto Restart	BOOL		OPERATOR
421	AR Mode	Auto Restart	ENUM		OPERATOR
422	AR Max Restarts	Auto Restart	USINT	1 to 20	OPERATOR
423	AR Trip Mask Lo	Auto Restart	DWORD		TECHNICIAN
424	AR Trip Mask Hi	Auto Restart	DWORD		TECHNICIAN
425	AR First Delay	Auto Restart	TIME	0.0 to 3600.0 s	OPERATOR

Tag	Parameter	Function Block	Type	Range	View
426	AR Delay	Auto Restart	TIME	0.0 to 3600.0 s	OPERATOR
427	AR Trip Msk B Lo	Auto Restart	DWORD		TECHNICIAN
428	AR Trip Msk B Hi	Auto Restart	DWORD		TECHNICIAN
429	AR First Delay B	Auto Restart	TIME	0.0 to 3600.0 s	OPERATOR
430	AR Delay B	Auto Restart	TIME	0.0 to 3600.0 s	OPERATOR
431	AR Active	Auto Restart	BOOL		OPERATOR
432	AR Pending	Auto Restart	BOOL		OPERATOR
433	AR Remaining	Auto Restart	USINT	0 to 20	OPERATOR
434	AR Time Left	Auto Restart	TIME	0.0 to 3600.0 s	OPERATOR
435	Comms Timeout	Comms Control	REAL	0 to 600 s	ENGINEER
436	Comms Command	Comms Control	WORD		TECHNICIAN
437	Comms Seq	Comms Control	BOOL		TECHNICIAN
438	Comms Ref	Comms Control	BOOL		TECHNICIAN
439	Activate	Fire Mode	BOOL		TECHNICIAN
440	Setpoint	Fire Mode	REAL	-100 to 100	TECHNICIAN
442	Restart Delay	Fire Mode	TIME	0.1 to 60.0 s	TECHNICIAN
443	Activated	Fire Mode	BOOL		TECHNICIAN
444	Ready	Fire Mode	BOOL		TECHNICIAN
447	Power Up Mode	Local Control	ENUM		TECHNICIAN
451	Remote Setpoint	Reference	REAL	-110 to 110 %	OPERATOR
452	Speed Trim	Reference	REAL	-300 to 300 %	OPERATOR
453	Max Speed Clamp	Reference	REAL	0 to 110 %	OPERATOR
454	Min Speed Clamp	Reference	REAL	-110 to 0 %	OPERATOR
455	Trim in Local	Reference	BOOL		OPERATOR
456	Local Min Speed	Reference	REAL	0 to 100 %	TECHNICIAN
457	Max Speed	Reference	REAL	0.1 to 100000 rpm	TECHNICIAN
458	Comms Setpoint	Reference	REAL	-110 to 110 %	TECHNICIAN
459	Local Setpoint	Reference	REAL	0 to 100 %	OPERATOR
460	Speed Demand	Reference	REAL	-200 to 200 %	OPERATOR
461	Speed Setpoint	Reference	REAL	-200 to 200 %	TECHNICIAN
462	Reference	Reference	REAL	-110 to 110 %	OPERATOR
464	Local Reverse	Reference	BOOL		OPERATOR
465	Ramp Type	Reference Ramp	ENUM		TECHNICIAN
466	Accel Time	Reference Ramp	TIME	0 to 3000 s	TECHNICIAN
467	Decel Time	Reference Ramp	TIME	0 to 3000 s	TECHNICIAN
468	Symmetric Mode	Reference Ramp	BOOL		TECHNICIAN
469	Symmetric Time	Reference Ramp	TIME	0 to 3000 s	TECHNICIAN
470	Sramp Accel	Reference Ramp	REAL	0 to 100 %/s ²	OPERATOR
471	Sramp Decel	Reference Ramp	REAL	0 to 100 %/s ²	TECHNICIAN
472	Sramp Jerk 1	Reference Ramp	REAL	0 to 100 %/s ³	TECHNICIAN
473	Sramp Jerk 2	Reference Ramp	REAL	0 to 100 %/s ³	TECHNICIAN
474	Sramp Jerk 3	Reference Ramp	REAL	0 to 100 %/s ³	TECHNICIAN
475	Sramp Jerk 4	Reference Ramp	REAL	0 to 100 %/s ³	TECHNICIAN
476	Sramp Continuous	Reference Ramp	BOOL		TECHNICIAN
477	Ramp Hold	Reference Ramp	BOOL		TECHNICIAN
478	Ramping Active	Reference Ramp	BOOL		TECHNICIAN

Tag	Parameter	Function Block	Type	Range	View
480	Jog Setpoint	Reference Jog	REAL	0 to 100 %	TECHNICIAN
481	Jog Accel Time	Reference Jog	TIME	0 to 3000 s	TECHNICIAN
482	Jog Decel Time	Reference Jog	TIME	0 to 3000 s	TECHNICIAN
483	Run Stop Mode	Reference Stop	ENUM		TECHNICIAN
484	Ramp Stop Time	Reference Stop	TIME	0 to 600 s	TECHNICIAN
485	Stop Zero Speed	Reference Stop	REAL	0 to 100 %	TECHNICIAN
486	Stop Delay	Reference Stop	TIME	0 to 30 s	TECHNICIAN
487	Fast Stop Limit	Reference Stop	TIME	0 to 3000 s	TECHNICIAN
488	Fast Stop Time	Reference Stop	TIME	0 to 600 s	TECHNICIAN
489	Final Stop Rate	Reference Stop	REAL	1 to 4800 Hz/s	TECHNICIAN
490	Run Forward	Sequencing	BOOL		TECHNICIAN
491	Run Reverse	Sequencing	BOOL		TECHNICIAN
492	Not Stop	Sequencing	BOOL		TECHNICIAN
493	Jog	Sequencing	BOOL		TECHNICIAN
494	Drive Enable	Sequencing	BOOL		TECHNICIAN
495	Not Fast Stop	Sequencing	BOOL		TECHNICIAN
496	Not Coast Stop	Sequencing	BOOL		TECHNICIAN
497	Remote Reverse	Sequencing	BOOL		TECHNICIAN
498	Rem Trip Reset	Sequencing	BOOL		TECHNICIAN
499	Trip Rst by Run	Sequencing	BOOL		TECHNICIAN
500	Power Up Start	Sequencing	BOOL		TECHNICIAN
501	External Trip	Sequencing	BOOL		TECHNICIAN
502	Local	Sequencing	BOOL		OPERATOR
503	Start Delay	Sequencing	TIME	0 to 30 s	TECHNICIAN
504	SwitchOn Timeout	Sequencing	TIME	0.0 to 100.0 s	TECHNICIAN
505	Remote Command	Sequencing	WORD		TECHNICIAN
506	Control Word	Sequencing	WORD		TECHNICIAN
507	Status Word	Sequencing	WORD		TECHNICIAN
508	Tripped	Sequencing	BOOL		OPERATOR
509	Running	Sequencing	BOOL		OPERATOR
510	Jogging	Sequencing	BOOL		OPERATOR
511	Stopping	Sequencing	BOOL		OPERATOR
512	Output Contactor	Sequencing	BOOL		OPERATOR
513	Switch On Enable	Sequencing	BOOL		OPERATOR
514	Switched On	Sequencing	BOOL		OPERATOR
515	Ready	Sequencing	BOOL		OPERATOR
516	System Reset	Sequencing	BOOL		OPERATOR
517	Sequencing State	Sequencing	ENUM		TECHNICIAN
518	Remote Rev Out	Sequencing	BOOL		TECHNICIAN
519	Healthy	Sequencing	BOOL		OPERATOR
520	Fan Running	Sequencing	BOOL		OPERATOR
530	Anin 1 Scale	Anin 1	REAL	-300.00 to 300.00 %	OPERATOR
531	Anin 1 Offset	Anin 1	REAL	-300 to 300 %	OPERATOR
532	Anin 1 Type	Anin 1	ENUM		OPERATOR
533	Break Value	Anin 1	REAL	-100 to 100 %	OPERATOR
534	Anin 1 Value	Anin 1	REAL		OPERATOR

Tag	Parameter	Function Block	Type	Range	View
535	Anin 1 Break	Anin 1	BOOL		OPERATOR
536	Anin 2 Scale	Anin 2	REAL	-300 to 300 %	OPERATOR
537	Anin 2 Offset	Anin 2	REAL	-300 to 300 %	OPERATOR
538	Anin 2 Type	Anin 2	ENUM		OPERATOR
539	Break Value	Anin 2	REAL	-100 to 100 %	OPERATOR
540	Anin 2 Value	Anin 2	REAL		OPERATOR
541	Anin 2 Break	Anin 2	BOOL		OPERATOR
558	Anout 1 Value	Anout 1	REAL	-300.00 to 300.00 %	OPERATOR
559	Anout 1 Scale	Anout 1	REAL	-300.00 to 300.00 %	OPERATOR
560	Anout 1 Offset	Anout 1	REAL	-300.00 to 300.00 %	OPERATOR
561	Anout 1 Abs	Anout 1	BOOL		OPERATOR
562	Anout 1 Type	Anout 1	ENUM		TECHNICIAN
563	Anout 2 Value	Anout 2	REAL	-300.00 to 300.00 %	OPERATOR
564	Anout 2 Scale	Anout 2	REAL	-300.00 to 300.00 %	OPERATOR
565	Anout 2 Offset	Anout 2	REAL	-300.00 to 300.00 %	OPERATOR
566	Anout 2 Abs	Anout 2	BOOL		OPERATOR
567	Anout 2 Type	Anout 2	ENUM		TECHNICIAN
568	Anout 3 Value	Anout 3	REAL	-300.00 to 300.00 %	OPERATOR
569	Anout 3 Scale	Anout 3	REAL	-300.00 to 300.00 %	OPERATOR
570	Anout 3 Offset	Anout 3	REAL	-300.00 to 300.00 %	OPERATOR
571	Anout 3 Abs	Anout 3	BOOL		OPERATOR
572	Anout 3 Type	Anout 3	ENUM		TECHNICIAN
583	Digin Pull Up	Digital Inputs	BOOL		TECHNICIAN
584	Digin Invert	Digital Inputs	WORD		OPERATOR
585	Digin 01 Invert	Digital Inputs	BIT		OPERATOR
586	Digin 02 Invert	Digital Inputs	BIT		OPERATOR
587	Digin 03 Invert	Digital Inputs	BIT		OPERATOR
588	Digin 04 Invert	Digital Inputs	BIT		OPERATOR
589	Digin 05 Invert	Digital Inputs	BIT		OPERATOR
590	Digin 06 Invert	Digital Inputs	BIT		OPERATOR
591	Digin 07 Invert	Digital Inputs	BIT		OPERATOR
592	Digin 08 Invert	Digital Inputs	BIT		OPERATOR
597	Digin 01	Digital Inputs	BIT		OPERATOR
598	Digin 02	Digital Inputs	BIT		OPERATOR
599	Digin 03	Digital Inputs	BIT		OPERATOR
600	Digin 04	Digital Inputs	BIT		OPERATOR
601	Digin 05	Digital Inputs	BIT		OPERATOR
602	Digin 06	Digital Inputs	BIT		OPERATOR
603	Digin 07	Digital Inputs	BIT		OPERATOR
604	Digin 08	Digital Inputs	BIT		OPERATOR
609	STO Inactive	Digital Inputs	BIT		OPERATOR
610	Digin Word	Digital Inputs	WORD		OPERATOR
611	Digout 01	Digital Outputs	BIT		OPERATOR
612	Digout 02	Digital Outputs	BIT		OPERATOR
616	Relay 01	Digital Outputs	BIT		OPERATOR
618	Digout 01 Invert	Digital Outputs	BIT		OPERATOR

Tag	Parameter	Function Block	Type	Range	View
619	Digout 02 Invert	Digital Outputs	BIT		OPERATOR
623	Relay 01 Invert	Digital Outputs	BIT		OPERATOR
625	Digout Word	Digital Outputs	WORD		OPERATOR
626	Digout Invert	Digital Outputs	WORD		OPERATOR
640	Address Method	Ethernet	ENUM		TECHNICIAN
641	Set IP Address	Ethernet	ADDR		TECHNICIAN
642	Set Subnet Mask	Ethernet	ADDR		TECHNICIAN
643	Set Gateway Addr	Ethernet	ADDR		TECHNICIAN
644	Last Auto IP	Ethernet	ADDR		ENGINEER
645	Address Is Temp	Ethernet	BOOL		ENGINEER
646	MAC Address	Ethernet	STRING		TECHNICIAN
651	IP Address	Ethernet	ADDR		OPERATOR
652	Subnet Mask	Ethernet	ADDR		OPERATOR
653	Gateway Address	Ethernet	ADDR		OPERATOR
654	Ethernet Link	Ethernet	ENUM		TECHNICIAN
655	Ethernet State	Ethernet	ENUM		OPERATOR
656	Max Connections	Modbus	USINT	0 to 3	TECHNICIAN
657	High Word First	Modbus	BOOL		TECHNICIAN
658	Process Timeout	Modbus	TIME	0 to 65	TECHNICIAN
659	Process Actv Reg	Modbus	UINT		TECHNICIAN
660	Modbus Timeout	Modbus	TIME	0 to 100000	TECHNICIAN
662	Mbus Mapping	Modbus	PREF		TECHNICIAN
661	Modbus Password	Modbus	WORD		TECHNICIAN
679	Mapping Valid	Modbus	BOOL		OPERATOR
680	Open Connections	Modbus	USINT		OPERATOR
681	Process Active	Modbus	BOOL		OPERATOR
682	Web Password	Web Server	STRING		ENGINEER
686	Web View Level	Web Server	ENUM		OPERATOR
688	Web Connections	Web Server	USINT		ENGINEER
689	DSE Connections	Web Server	USINT		TECHNICIAN
690	Scope Connection	Web Server	USINT		TECHNICIAN
791	Fieldbus	Fieldbus	ENUM		TECHNICIAN
792	Input Mapping	Fieldbus	PREF		TECHNICIAN
825	Out Mapping	Fieldbus	PREF		TECHNICIAN
868	Fieldbus State	Fieldbus	ENUM		OPERATOR
869	Fieldbus Diag	Fieldbus	ENUM		OPERATOR
870	Enable Trips Lo	Trips Status	DWORD		TECHNICIAN
871	Enable Trips Hi	Trips Status	DWORD		TECHNICIAN
872	Display Warnings	Trips Status	BOOL		OPERATOR
873	Show Warnings Lo	Trips Status	DWORD		TECHNICIAN
874	Show Warnings Hi	Trips Status	DWORD		TECHNICIAN
876	Active Trips Lo	Trips Status	DWORD		OPERATOR
877	Active Trips Hi	Trips Status	DWORD		OPERATOR
878	Warnings Lo	Trips Status	DWORD		OPERATOR
879	Warnings Hi	Trips Status	DWORD		OPERATOR
880	First Trip	Trips Status	ENUM		OPERATOR

Tag	Parameter	Function Block	Type	Range	View
881	Trip A1	App Trips	BOOL		TECHNICIAN
882	Trip A2	App Trips	BOOL		TECHNICIAN
883	Trip A3	App Trips	BOOL		TECHNICIAN
884	Trip A4	App Trips	BOOL		TECHNICIAN
885	Spd Error Enable	Speed Error Trip	BOOL		TECHNICIAN
886	Spd Error Level	Speed Error Trip	REAL	0.0 to 100.0 %	TECHNICIAN
887	Spd Error Delay	Speed Error Trip	TIME	0 to 2000	TECHNICIAN
888	Stall Limit Type	Stall Trip	ENUM		TECHNICIAN
889	Stall Time	Stall Trip	TIME	0.1 to 2000	TECHNICIAN
890	Stall Torq Trip	Stall Trip	BOOL		TECHNICIAN
891	Stall Cur Trip	Stall Trip	BOOL		TECHNICIAN
892	Thermistor Type	Thermistor Trip	ENUM		TECHNICIAN
893	VDC Ripple Filt TC	VDC Ripple	TIME	0.1 to 100	ENGINEER
894	VDC Ripple Hyst	VDC Ripple	REAL	0 to 50 V	ENGINEER
895	VDC Sample Time	VDC Ripple	TIME	0.003 to 0.1	ENGINEER
898	VDC Ripple Level	VDC Ripple	REAL	0 to 500 V	ENGINEER
899	VDC Ripple Filtered	VDC Ripple	REAL	0 to 500 V	TECHNICIAN
900	Recent Trips	Trips History	ENUM		OPERATOR
920	OPER. Passwrd On	Keypad	BOOL		TECHNICIAN
921	Local Passwrd On	Keypad	BOOL		TECHNICIAN
922	TECHN. Passwrd	Keypad	WORD		OPERATOR
923	ENGINEER Passwrd	Keypad	WORD		TECHNICIAN
924	Display Timeout	Keypad	TIME	0 to 86400 s	TECHNICIAN
925	Enabled Keys	Keypad	WORD		TECHNICIAN
926	Run Key Action	Keypad	ENUM		OPERATOR
927	Key Data	Keypad	WORD		TECHNICIAN
928	Enable Auto Save	Customise Menus	BOOL		ENGINEER
929	Auto Hide	Customise Menus	BOOL		ENGINEER
930	Operator Menu	Customise Menus	PREF		OPERATOR
963	Save is Required	Customise Menus	BOOL		TECHNICIAN
968	Filter Display	Customise Menus	BOOL		OPERATOR
970	Target State	Device State	ENUM		OPERATOR
971	Actual State	Device State	ENUM		OPERATOR
972	Config Fault	Device State	ENUM		OPERATOR
973	RTA Code	Device State	UINT		OPERATOR
974	RTA Data	Device State	DWORD		OPERATOR
975	RTA Thread	Device State	SINT		OPERATOR
976	Reset to Default	Device Commands	BOOL		ENGINEER
977	Save All	Device Commands	BOOL		TECHNICIAN
978	Upgrade Firmware	Device Commands	BOOL		TECHNICIAN
979	Reset Processor	Device Commands	BOOL		ENGINEER
1000	Drive Name	Drive Info	STRING		TECHNICIAN
1005	Frame Size	Drive Info	USINT	0 to 10	OPERATOR
1006	Nominal Supply	Drive Info	ENUM		TECHNICIAN
1007	Firmware Version	Drive Info	STRING		OPERATOR
1013	Boot Version	Drive Info	STRING		ENGINEER

Tag	Parameter	Function Block	Type	Range	View
1015	Boot Version Num	Drive Info	WORD		ENGINEER
1016	Power Stack	Drive Info	ENUM		ENGINEER
1017	Ctrl Board Age	Runtime Statistics	UDINT		OPERATOR
1018	Time Since Reset	Runtime Statistics	TIME		TECHNICIAN
1019	HV SMPS Up Time	Runtime Statistics	UDINT		TECHNICIAN
1020	HV Power On Cnt	Runtime Statistics	UINT		TECHNICIAN
1021	Motor Run Time	Runtime Statistics	UDINT		TECHNICIAN
1022	Motor Start Cnt	Runtime Statistics	UDINT		TECHNICIAN
1071	Save Pcode Data	Product Data	BOOL		ENGINEER
1072	Stack ID	Product Data	UINT		ENGINEER
1073	Serial Number	Product Data	STRING		OPERATOR
1077	OEM ID	Product Data	UINT		ENGINEER
1078	Build Flags	Product Data	WORD		ENGINEER
1079	Prod Data Key	Product Data	DWORD		ENGINEER
1083	Clone Filename	Clone	STRING		TECHNICIAN
1087	Clone Direction	Clone	ENUM		TECHNICIAN
1088	Restore Mode	Clone	ENUM		TECHNICIAN
1089	Stack Parameters	Clone	ENUM		TECHNICIAN
1090	Motor Parameters	Clone	ENUM		TECHNICIAN
1091	Configuration	Clone	ENUM		TECHNICIAN
1093	Clone Start	Clone	BOOL		TECHNICIAN
1094	Clone Status	Clone	ENUM		TECHNICIAN
1105	Keypad Test Code	Production Test	USINT		OPERATOR
1150	Application	App Config	ENUM		TECHNICIAN
1151	Load Application	App Config	BOOL		TECHNICIAN
1152	Application Lock	App Config	BOOL		TECHNICIAN
1164	Config Id	App Config	UDINT		OPERATOR
1165	Config Revision	App Config	INT		OPERATOR
1166	Config Filename	App Config	STRING		OPERATOR
1174	Level	At Load	REAL	-300.0 to 300.0 %	OPERATOR
1175	Absolute	At Load	BOOL		OPERATOR
1176	At Or Above Load	At Load	BOOL		OPERATOR
1177	Hysteresis	At Speed	REAL	0.0 to 300.0 %	OPERATOR
1178	At Speed	At Speed	BOOL		OPERATOR
1179	Start	Auto Circulate	BOOL		OPERATOR
1180	Continue	Auto Circulate	BOOL		OPERATOR
1181	Stages	Auto Circulate	USINT	2 to 8	OPERATOR
1182	Cycles	Auto Circulate	UINT		OPERATOR
1183	Keep Running	Auto Circulate	BOOL		OPERATOR
1184	Running Time	Auto Circulate	REAL	0.1 to 3000.0 s	OPERATOR
1193	Stop Time	Auto Circulate	REAL	0.0 to 3000.0 s	OPERATOR
1202	Run	Auto Circulate	BOOL		OPERATOR
1203	Stage	Auto Circulate	USINT		OPERATOR
1204	Cycle	Auto Circulate	UDINT		OPERATOR
1205	On Load	Brake Control	REAL	0.0 to 150.0 %	OPERATOR
1206	On Frequency	Brake Control	REAL	0.0 to 500.0 Hz	OPERATOR

Tag	Parameter	Function Block	Type	Range	View
1207	Off Frequency	Brake Control	REAL	0.0 to 500.0 Hz	OPERATOR
1208	On Hold Time	Brake Control	REAL	0.0 to 300.0 s	OPERATOR
1209	Off Hold Time	Brake Control	REAL	0.0 to 300.0 s	OPERATOR
1210	Release	Brake Control	BOOL		OPERATOR
1211	Hold	Brake Control	BOOL		OPERATOR
1212	Input	Demultiplexer 1	WORD		OPERATOR
1213	Output 0	Demultiplexer 1	BIT		OPERATOR
1214	Output 1	Demultiplexer 1	BIT		OPERATOR
1215	Output 2	Demultiplexer 1	BIT		OPERATOR
1216	Output 3	Demultiplexer 1	BIT		OPERATOR
1217	Output 4	Demultiplexer 1	BIT		OPERATOR
1218	Output 5	Demultiplexer 1	BIT		OPERATOR
1219	Output 6	Demultiplexer 1	BIT		OPERATOR
1220	Output 7	Demultiplexer 1	BIT		OPERATOR
1221	Output 8	Demultiplexer 1	BIT		OPERATOR
1222	Output 9	Demultiplexer 1	BIT		OPERATOR
1223	Output 10	Demultiplexer 1	BIT		OPERATOR
1224	Output 11	Demultiplexer 1	BIT		OPERATOR
1225	Output 12	Demultiplexer 1	BIT		OPERATOR
1226	Output 13	Demultiplexer 1	BIT		OPERATOR
1227	Output 14	Demultiplexer 1	BIT		OPERATOR
1228	Output 15	Demultiplexer 1	BIT		OPERATOR
1229	Input	Demultiplexer 2	WORD		OPERATOR
1230	Output 0	Demultiplexer 2	BIT		OPERATOR
1231	Output 1	Demultiplexer 2	BIT		OPERATOR
1232	Output 2	Demultiplexer 2	BIT		OPERATOR
1233	Output 3	Demultiplexer 2	BIT		OPERATOR
1234	Output 4	Demultiplexer 2	BIT		OPERATOR
1235	Output 5	Demultiplexer 2	BIT		OPERATOR
1236	Output 6	Demultiplexer 2	BIT		OPERATOR
1237	Output 7	Demultiplexer 2	BIT		OPERATOR
1238	Output 8	Demultiplexer 2	BIT		OPERATOR
1239	Output 9	Demultiplexer 2	BIT		OPERATOR
1240	Output 10	Demultiplexer 2	BIT		OPERATOR
1241	Output 11	Demultiplexer 2	BIT		OPERATOR
1242	Output 12	Demultiplexer 2	BIT		OPERATOR
1243	Output 13	Demultiplexer 2	BIT		OPERATOR
1244	Output 14	Demultiplexer 2	BIT		OPERATOR
1245	Output 15	Demultiplexer 2	BIT		OPERATOR
1246	Source	Link 1	PREF		ENGINEER
1247	Destination	Link 1	PREF		ENGINEER
1248	Source	Link 2	PREF		ENGINEER
1249	Destination	Link 2	PREF		ENGINEER
1250	Source	Link 3	PREF		ENGINEER
1251	Destination	Link 3	PREF		ENGINEER
1252	Source	Link 4	PREF		ENGINEER

Tag	Parameter	Function Block	Type	Range	View
1253	Destination	Link 4	PREF		ENGINEER
1254	Source	Link 5	PREF		ENGINEER
1255	Destination	Link 5	PREF		ENGINEER
1256	Source	Link 6	PREF		ENGINEER
1257	Destination	Link 6	PREF		ENGINEER
1258	Source	Link 7	PREF		ENGINEER
1259	Destination	Link 7	PREF		ENGINEER
1260	Source	Link 8	PREF		ENGINEER
1261	Destination	Link 8	PREF		ENGINEER
1262	Source	Link 9	PREF		ENGINEER
1263	Destination	Link 9	PREF		ENGINEER
1264	Source	Link 10	PREF		ENGINEER
1265	Destination	Link 10	PREF		ENGINEER
1266	Source	Link 11	PREF		ENGINEER
1267	Destination	Link 11	PREF		ENGINEER
1268	Source	Link 12	PREF		ENGINEER
1269	Destination	Link 12	PREF		ENGINEER
1270	Source	Link 13	PREF		ENGINEER
1271	Destination	Link 13	PREF		ENGINEER
1272	Source	Link 14	PREF		ENGINEER
1273	Destination	Link 14	PREF		ENGINEER
1274	Source	Link 15	PREF		ENGINEER
1275	Destination	Link 15	PREF		ENGINEER
1276	Source	Link 16	PREF		ENGINEER
1277	Destination	Link 16	PREF		ENGINEER
1278	Source	Link 17	PREF		ENGINEER
1279	Destination	Link 17	PREF		ENGINEER
1280	Source	Link 18	PREF		ENGINEER
1281	Destination	Link 18	PREF		ENGINEER
1282	Source	Link 19	PREF		ENGINEER
1283	Destination	Link 19	PREF		ENGINEER
1284	Source	Link 20	PREF		ENGINEER
1285	Destination	Link 20	PREF		ENGINEER
1286	Source	Link 21	PREF		ENGINEER
1287	Destination	Link 21	PREF		ENGINEER
1288	Source	Link 22	PREF		ENGINEER
1289	Destination	Link 22	PREF		ENGINEER
1290	Source	Link 23	PREF		ENGINEER
1291	Destination	Link 23	PREF		ENGINEER
1292	Source	Link 24	PREF		ENGINEER
1293	Destination	Link 24	PREF		ENGINEER
1294	Source	Link 25	PREF		ENGINEER
1295	Destination	Link 25	PREF		ENGINEER
1296	Source	Link 26	PREF		ENGINEER
1297	Destination	Link 26	PREF		ENGINEER
1298	Source	Link 27	PREF		ENGINEER

Tag	Parameter	Function Block	Type	Range	View
1299	Destination	Link 27	PREF		ENGINEER
1300	Source	Link 28	PREF		ENGINEER
1301	Destination	Link 28	PREF		ENGINEER
1302	Source	Link 29	PREF		ENGINEER
1303	Destination	Link 29	PREF		ENGINEER
1304	Source	Link 30	PREF		ENGINEER
1305	Destination	Link 30	PREF		ENGINEER
1306	Source	Link 31	PREF		ENGINEER
1307	Destination	Link 31	PREF		ENGINEER
1308	Source	Link 32	PREF		ENGINEER
1309	Destination	Link 32	PREF		ENGINEER
1310	Source	Link 33	PREF		ENGINEER
1311	Destination	Link 33	PREF		ENGINEER
1312	Source	Link 34	PREF		ENGINEER
1313	Destination	Link 34	PREF		ENGINEER
1314	Source	Link 35	PREF		ENGINEER
1315	Destination	Link 35	PREF		ENGINEER
1316	Source	Link 36	PREF		ENGINEER
1317	Destination	Link 36	PREF		ENGINEER
1318	Source	Link 37	PREF		ENGINEER
1319	Destination	Link 37	PREF		ENGINEER
1320	Source	Link 38	PREF		ENGINEER
1321	Destination	Link 38	PREF		ENGINEER
1322	Source	Link 39	PREF		ENGINEER
1323	Destination	Link 39	PREF		ENGINEER
1324	Source	Link 40	PREF		ENGINEER
1325	Destination	Link 40	PREF		ENGINEER
1326	Source	Link 41	PREF		ENGINEER
1327	Destination	Link 41	PREF		ENGINEER
1328	Source	Link 42	PREF		ENGINEER
1329	Destination	Link 42	PREF		ENGINEER
1330	Source	Link 43	PREF		ENGINEER
1331	Destination	Link 43	PREF		ENGINEER
1332	Source	Link 44	PREF		ENGINEER
1333	Destination	Link 44	PREF		ENGINEER
1334	Source	Link 45	PREF		ENGINEER
1335	Destination	Link 45	PREF		ENGINEER
1336	Source	Link 46	PREF		ENGINEER
1337	Destination	Link 46	PREF		ENGINEER
1338	Source	Link 47	PREF		ENGINEER
1339	Destination	Link 47	PREF		ENGINEER
1340	Source	Link 48	PREF		ENGINEER
1341	Destination	Link 48	PREF		ENGINEER
1342	Source	Link 49	PREF		ENGINEER
1343	Destination	Link 49	PREF		ENGINEER
1344	Source	Link 50	PREF		ENGINEER

Tag	Parameter	Function Block	Type	Range	View
1345	Destination	Link 50	PREF		ENGINEER
1346	Source	Link 51	PREF		ENGINEER
1347	Destination	Link 51	PREF		ENGINEER
1348	Source	Link 52	PREF		ENGINEER
1349	Destination	Link 52	PREF		ENGINEER
1350	Source	Link 53	PREF		ENGINEER
1351	Destination	Link 53	PREF		ENGINEER
1352	Source	Link 54	PREF		ENGINEER
1353	Destination	Link 54	PREF		ENGINEER
1354	Source	Link 55	PREF		ENGINEER
1355	Destination	Link 55	PREF		ENGINEER
1356	Source	Link 56	PREF		ENGINEER
1357	Destination	Link 56	PREF		ENGINEER
1358	Source	Link 57	PREF		ENGINEER
1359	Destination	Link 57	PREF		ENGINEER
1360	Source	Link 58	PREF		ENGINEER
1361	Destination	Link 58	PREF		ENGINEER
1362	Source	Link 59	PREF		ENGINEER
1363	Destination	Link 59	PREF		ENGINEER
1364	Source	Link 60	PREF		ENGINEER
1365	Destination	Link 60	PREF		ENGINEER
1366	Source	Link 61	PREF		ENGINEER
1367	Destination	Link 61	PREF		ENGINEER
1368	Source	Link 62	PREF		ENGINEER
1369	Destination	Link 62	PREF		ENGINEER
1370	Source	Link 63	PREF		ENGINEER
1371	Destination	Link 63	PREF		ENGINEER
1372	Source	Link 64	PREF		ENGINEER
1373	Destination	Link 64	PREF		ENGINEER
1374	Source	Link 65	PREF		ENGINEER
1375	Destination	Link 65	PREF		ENGINEER
1376	Source	Link 66	PREF		ENGINEER
1377	Destination	Link 66	PREF		ENGINEER
1378	Source	Link 67	PREF		ENGINEER
1379	Destination	Link 67	PREF		ENGINEER
1380	Source	Link 68	PREF		ENGINEER
1381	Destination	Link 68	PREF		ENGINEER
1382	Source	Link 69	PREF		ENGINEER
1383	Destination	Link 69	PREF		ENGINEER
1384	Source	Link 70	PREF		ENGINEER
1385	Destination	Link 70	PREF		ENGINEER
1386	Source	Link 71	PREF		ENGINEER
1387	Destination	Link 71	PREF		ENGINEER
1388	Source	Link 72	PREF		ENGINEER
1389	Destination	Link 72	PREF		ENGINEER
1390	Source	Link 73	PREF		ENGINEER

Tag	Parameter	Function Block	Type	Range	View
1391	Destination	Link 73	PREF		ENGINEER
1392	Source	Link 74	PREF		ENGINEER
1393	Destination	Link 74	PREF		ENGINEER
1394	Source	Link 75	PREF		ENGINEER
1395	Destination	Link 75	PREF		ENGINEER
1396	Source	Link 76	PREF		ENGINEER
1397	Destination	Link 76	PREF		ENGINEER
1398	Source	Link 77	PREF		ENGINEER
1399	Destination	Link 77	PREF		ENGINEER
1400	Source	Link 78	PREF		ENGINEER
1401	Destination	Link 78	PREF		ENGINEER
1402	Source	Link 79	PREF		ENGINEER
1403	Destination	Link 79	PREF		ENGINEER
1404	Source	Link 80	PREF		ENGINEER
1405	Destination	Link 80	PREF		ENGINEER
1406	Source	Link 81	PREF		ENGINEER
1407	Destination	Link 81	PREF		ENGINEER
1408	Source	Link 82	PREF		ENGINEER
1409	Destination	Link 82	PREF		ENGINEER
1410	Source	Link 83	PREF		ENGINEER
1411	Destination	Link 83	PREF		ENGINEER
1412	Source	Link 84	PREF		ENGINEER
1413	Destination	Link 84	PREF		ENGINEER
1414	Source	Link 85	PREF		ENGINEER
1415	Destination	Link 85	PREF		ENGINEER
1416	Source	Link 86	PREF		ENGINEER
1417	Destination	Link 86	PREF		ENGINEER
1418	Source	Link 87	PREF		ENGINEER
1419	Destination	Link 87	PREF		ENGINEER
1420	Source	Link 88	PREF		ENGINEER
1421	Destination	Link 88	PREF		ENGINEER
1422	Source	Link 89	PREF		ENGINEER
1423	Destination	Link 89	PREF		ENGINEER
1424	Source	Link 90	PREF		ENGINEER
1425	Destination	Link 90	PREF		ENGINEER
1426	Source	Link 91	PREF		ENGINEER
1427	Destination	Link 91	PREF		ENGINEER
1428	Source	Link 92	PREF		ENGINEER
1429	Destination	Link 92	PREF		ENGINEER
1430	Source	Link 93	PREF		ENGINEER
1431	Destination	Link 93	PREF		ENGINEER
1432	Source	Link 94	PREF		ENGINEER
1433	Destination	Link 94	PREF		ENGINEER
1434	Source	Link 95	PREF		ENGINEER
1435	Destination	Link 95	PREF		ENGINEER
1436	Source	Link 96	PREF		ENGINEER

Tag	Parameter	Function Block	Type	Range	View
1437	Destination	Link 96	PREF		ENGINEER
1438	Source	Link 97	PREF		ENGINEER
1439	Destination	Link 97	PREF		ENGINEER
1440	Source	Link 98	PREF		ENGINEER
1441	Destination	Link 98	PREF		ENGINEER
1442	Source	Link 99	PREF		ENGINEER
1443	Destination	Link 99	PREF		ENGINEER
1444	Source	Link 100	PREF		ENGINEER
1445	Destination	Link 100	PREF		ENGINEER
1446	Source	Link 101	PREF		ENGINEER
1447	Destination	Link 101	PREF		ENGINEER
1448	Source	Link 102	PREF		ENGINEER
1449	Destination	Link 102	PREF		ENGINEER
1450	Source	Link 103	PREF		ENGINEER
1451	Destination	Link 103	PREF		ENGINEER
1452	Source	Link 104	PREF		ENGINEER
1453	Destination	Link 104	PREF		ENGINEER
1454	Source	Link 105	PREF		ENGINEER
1455	Destination	Link 105	PREF		ENGINEER
1456	Source	Link 106	PREF		ENGINEER
1457	Destination	Link 106	PREF		ENGINEER
1458	Source	Link 107	PREF		ENGINEER
1459	Destination	Link 107	PREF		ENGINEER
1460	Source	Link 108	PREF		ENGINEER
1461	Destination	Link 108	PREF		ENGINEER
1462	Source	Link 109	PREF		ENGINEER
1463	Destination	Link 109	PREF		ENGINEER
1464	Source	Link 110	PREF		ENGINEER
1465	Destination	Link 110	PREF		ENGINEER
1466	Source	Link 111	PREF		ENGINEER
1467	Destination	Link 111	PREF		ENGINEER
1468	Source	Link 112	PREF		ENGINEER
1469	Destination	Link 112	PREF		ENGINEER
1470	Source	Link 113	PREF		ENGINEER
1471	Destination	Link 113	PREF		ENGINEER
1472	Source	Link 114	PREF		ENGINEER
1473	Destination	Link 114	PREF		ENGINEER
1474	Source	Link 115	PREF		ENGINEER
1475	Destination	Link 115	PREF		ENGINEER
1476	Source	Link 116	PREF		ENGINEER
1477	Destination	Link 116	PREF		ENGINEER
1478	Source	Link 117	PREF		ENGINEER
1479	Destination	Link 117	PREF		ENGINEER
1480	Source	Link 118	PREF		ENGINEER
1481	Destination	Link 118	PREF		ENGINEER
1482	Source	Link 119	PREF		ENGINEER

Tag	Parameter	Function Block	Type	Range	View
1483	Destination	Link 119	PREF		ENGINEER
1484	Source	Link 120	PREF		ENGINEER
1485	Destination	Link 120	PREF		ENGINEER
1486	Source	Link 121	PREF		ENGINEER
1487	Destination	Link 121	PREF		ENGINEER
1488	Source	Link 122	PREF		ENGINEER
1489	Destination	Link 122	PREF		ENGINEER
1490	Source	Link 123	PREF		ENGINEER
1491	Destination	Link 123	PREF		ENGINEER
1492	Source	Link 124	PREF		ENGINEER
1493	Destination	Link 124	PREF		ENGINEER
1494	Source	Link 125	PREF		ENGINEER
1495	Destination	Link 125	PREF		ENGINEER
1496	Source	Link 126	PREF		ENGINEER
1497	Destination	Link 126	PREF		ENGINEER
1498	Source	Link 127	PREF		ENGINEER
1499	Destination	Link 127	PREF		ENGINEER
1500	Source	Link 128	PREF		ENGINEER
1501	Destination	Link 128	PREF		ENGINEER
1502	Source	Link 129	PREF		ENGINEER
1503	Destination	Link 129	PREF		ENGINEER
1504	Source	Link 130	PREF		ENGINEER
1505	Destination	Link 130	PREF		ENGINEER
1506	Source	Link 131	PREF		ENGINEER
1507	Destination	Link 131	PREF		ENGINEER
1508	Source	Link 132	PREF		ENGINEER
1509	Destination	Link 132	PREF		ENGINEER
1510	Source	Link 133	PREF		ENGINEER
1511	Destination	Link 133	PREF		ENGINEER
1512	Source	Link 134	PREF		ENGINEER
1513	Destination	Link 134	PREF		ENGINEER
1514	Source	Link 135	PREF		ENGINEER
1515	Destination	Link 135	PREF		ENGINEER
1516	Source	Link 136	PREF		ENGINEER
1517	Destination	Link 136	PREF		ENGINEER
1518	Source	Link 137	PREF		ENGINEER
1519	Destination	Link 137	PREF		ENGINEER
1520	Source	Link 138	PREF		ENGINEER
1521	Destination	Link 138	PREF		ENGINEER
1522	Source	Link 139	PREF		ENGINEER
1523	Destination	Link 139	PREF		ENGINEER
1524	Source	Link 140	PREF		ENGINEER
1525	Destination	Link 140	PREF		ENGINEER
1526	Source	Link 141	PREF		ENGINEER
1527	Destination	Link 141	PREF		ENGINEER
1528	Source	Link 142	PREF		ENGINEER

Tag	Parameter	Function Block	Type	Range	View
1529	Destination	Link 142	PREF		ENGINEER
1530	Source	Link 143	PREF		ENGINEER
1531	Destination	Link 143	PREF		ENGINEER
1532	Source	Link 144	PREF		ENGINEER
1533	Destination	Link 144	PREF		ENGINEER
1534	Source	Link 145	PREF		ENGINEER
1535	Destination	Link 145	PREF		ENGINEER
1536	Source	Link 146	PREF		ENGINEER
1537	Destination	Link 146	PREF		ENGINEER
1538	Source	Link 147	PREF		ENGINEER
1539	Destination	Link 147	PREF		ENGINEER
1540	Source	Link 148	PREF		ENGINEER
1541	Destination	Link 148	PREF		ENGINEER
1542	Source	Link 149	PREF		ENGINEER
1543	Destination	Link 149	PREF		ENGINEER
1544	Source	Link 150	PREF		ENGINEER
1545	Destination	Link 150	PREF		ENGINEER
1546	Source	Link 151	PREF		ENGINEER
1547	Destination	Link 151	PREF		ENGINEER
1548	Source	Link 152	PREF		ENGINEER
1549	Destination	Link 152	PREF		ENGINEER
1550	Source	Link 153	PREF		ENGINEER
1551	Destination	Link 153	PREF		ENGINEER
1552	Source	Link 154	PREF		ENGINEER
1553	Destination	Link 154	PREF		ENGINEER
1554	Source	Link 155	PREF		ENGINEER
1555	Destination	Link 155	PREF		ENGINEER
1556	Source	Link 156	PREF		ENGINEER
1557	Destination	Link 156	PREF		ENGINEER
1558	Source	Link 157	PREF		ENGINEER
1559	Destination	Link 157	PREF		ENGINEER
1560	Source	Link 158	PREF		ENGINEER
1561	Destination	Link 158	PREF		ENGINEER
1562	Source	Link 159	PREF		ENGINEER
1563	Destination	Link 159	PREF		ENGINEER
1564	Source	Link 160	PREF		ENGINEER
1565	Destination	Link 160	PREF		ENGINEER
1566	Source	Link 161	PREF		ENGINEER
1567	Destination	Link 161	PREF		ENGINEER
1568	Source	Link 162	PREF		ENGINEER
1569	Destination	Link 162	PREF		ENGINEER
1570	Source	Link 163	PREF		ENGINEER
1571	Destination	Link 163	PREF		ENGINEER
1572	Source	Link 164	PREF		ENGINEER
1573	Destination	Link 164	PREF		ENGINEER
1574	Source	Link 165	PREF		ENGINEER

Tag	Parameter	Function Block	Type	Range	View
1575	Destination	Link 165	PREF		ENGINEER
1576	Source	Link 166	PREF		ENGINEER
1577	Destination	Link 166	PREF		ENGINEER
1578	Source	Link 167	PREF		ENGINEER
1579	Destination	Link 167	PREF		ENGINEER
1580	Source	Link 168	PREF		ENGINEER
1581	Destination	Link 168	PREF		ENGINEER
1582	Source	Link 169	PREF		ENGINEER
1583	Destination	Link 169	PREF		ENGINEER
1584	Source	Link 170	PREF		ENGINEER
1585	Destination	Link 170	PREF		ENGINEER
1586	Source	Link 171	PREF		ENGINEER
1587	Destination	Link 171	PREF		ENGINEER
1588	Source	Link 172	PREF		ENGINEER
1589	Destination	Link 172	PREF		ENGINEER
1590	Source	Link 173	PREF		ENGINEER
1591	Destination	Link 173	PREF		ENGINEER
1592	Source	Link 174	PREF		ENGINEER
1593	Destination	Link 174	PREF		ENGINEER
1594	Source	Link 175	PREF		ENGINEER
1595	Destination	Link 175	PREF		ENGINEER
1596	Source	Link 176	PREF		ENGINEER
1597	Destination	Link 176	PREF		ENGINEER
1598	Source	Link 177	PREF		ENGINEER
1599	Destination	Link 177	PREF		ENGINEER
1600	Source	Link 178	PREF		ENGINEER
1601	Destination	Link 178	PREF		ENGINEER
1602	Source	Link 179	PREF		ENGINEER
1603	Destination	Link 179	PREF		ENGINEER
1604	Source	Link 180	PREF		ENGINEER
1605	Destination	Link 180	PREF		ENGINEER
1606	Source	Link 181	PREF		ENGINEER
1607	Destination	Link 181	PREF		ENGINEER
1608	Source	Link 182	PREF		ENGINEER
1609	Destination	Link 182	PREF		ENGINEER
1610	Source	Link 183	PREF		ENGINEER
1611	Destination	Link 183	PREF		ENGINEER
1612	Source	Link 184	PREF		ENGINEER
1613	Destination	Link 184	PREF		ENGINEER
1614	Source	Link 185	PREF		ENGINEER
1615	Destination	Link 185	PREF		ENGINEER
1616	Source	Link 186	PREF		ENGINEER
1617	Destination	Link 186	PREF		ENGINEER
1618	Source	Link 187	PREF		ENGINEER
1619	Destination	Link 187	PREF		ENGINEER
1620	Source	Link 188	PREF		ENGINEER

Tag	Parameter	Function Block	Type	Range	View
1621	Destination	Link 188	PREF		ENGINEER
1622	Source	Link 189	PREF		ENGINEER
1623	Destination	Link 189	PREF		ENGINEER
1624	Source	Link 190	PREF		ENGINEER
1625	Destination	Link 190	PREF		ENGINEER
1626	Source	Link 191	PREF		ENGINEER
1627	Destination	Link 191	PREF		ENGINEER
1628	Source	Link 192	PREF		ENGINEER
1629	Destination	Link 192	PREF		ENGINEER
1630	Source	Link 193	PREF		ENGINEER
1631	Destination	Link 193	PREF		ENGINEER
1632	Source	Link 194	PREF		ENGINEER
1633	Destination	Link 194	PREF		ENGINEER
1634	Source	Link 195	PREF		ENGINEER
1635	Destination	Link 195	PREF		ENGINEER
1636	Source	Link 196	PREF		ENGINEER
1637	Destination	Link 196	PREF		ENGINEER
1638	Source	Link 197	PREF		ENGINEER
1639	Destination	Link 197	PREF		ENGINEER
1640	Source	Link 198	PREF		ENGINEER
1641	Destination	Link 198	PREF		ENGINEER
1642	Source	Link 199	PREF		ENGINEER
1643	Destination	Link 199	PREF		ENGINEER
1644	Source	Link 200	PREF		ENGINEER
1645	Destination	Link 200	PREF		ENGINEER
1646	Input A	LogicFunc 1	BOOL		OPERATOR
1647	Input B	LogicFunc 1	BOOL		OPERATOR
1648	Input C	LogicFunc 1	BOOL		OPERATOR
1649	Type	LogicFunc 1	ENUM		OPERATOR
1650	Output	LogicFunc 1	BOOL		OPERATOR
1651	Input A	LogicFunc 2	BOOL		OPERATOR
1652	Input B	LogicFunc 2	BOOL		OPERATOR
1653	Input C	LogicFunc 2	BOOL		OPERATOR
1654	Type	LogicFunc 2	ENUM		OPERATOR
1655	Output	LogicFunc 2	BOOL		OPERATOR
1656	Input A	LogicFunc 3	BOOL		OPERATOR
1657	Input B	LogicFunc 3	BOOL		OPERATOR
1658	Input C	LogicFunc 3	BOOL		OPERATOR
1659	Type	LogicFunc 3	ENUM		OPERATOR
1660	Output	LogicFunc 3	BOOL		OPERATOR
1661	Input A	LogicFunc 4	BOOL		OPERATOR
1662	Input B	LogicFunc 4	BOOL		OPERATOR
1663	Input C	LogicFunc 4	BOOL		OPERATOR
1664	Type	LogicFunc 4	ENUM		OPERATOR
1665	Output	LogicFunc 4	BOOL		OPERATOR
1666	Input A	LogicFunc 5	BOOL		OPERATOR

Tag	Parameter	Function Block	Type	Range	View
1667	Input B	LogicFunc 5	BOOL		OPERATOR
1668	Input C	LogicFunc 5	BOOL		OPERATOR
1669	Type	LogicFunc 5	ENUM		OPERATOR
1670	Output	LogicFunc 5	BOOL		OPERATOR
1671	Input A	LogicFunc 6	BOOL		OPERATOR
1672	Input B	LogicFunc 6	BOOL		OPERATOR
1673	Input C	LogicFunc 6	BOOL		OPERATOR
1674	Type	LogicFunc 6	ENUM		OPERATOR
1675	Output	LogicFunc 6	BOOL		OPERATOR
1676	Input A	LogicFunc 7	BOOL		OPERATOR
1677	Input B	LogicFunc 7	BOOL		OPERATOR
1678	Input C	LogicFunc 7	BOOL		OPERATOR
1679	Type	LogicFunc 7	ENUM		OPERATOR
1680	Output	LogicFunc 7	BOOL		OPERATOR
1681	Input A	LogicFunc 8	BOOL		OPERATOR
1682	Input B	LogicFunc 8	BOOL		OPERATOR
1683	Input C	LogicFunc 8	BOOL		OPERATOR
1684	Type	LogicFunc 8	ENUM		OPERATOR
1685	Output	LogicFunc 8	BOOL		OPERATOR
1686	Input A	LogicFunc 9	BOOL		OPERATOR
1687	Input B	LogicFunc 9	BOOL		OPERATOR
1688	Input C	LogicFunc 9	BOOL		OPERATOR
1689	Type	LogicFunc 9	ENUM		OPERATOR
1690	Output	LogicFunc 9	BOOL		OPERATOR
1691	Input A	LogicFunc 10	BOOL		OPERATOR
1692	Input B	LogicFunc 10	BOOL		OPERATOR
1693	Input C	LogicFunc 10	BOOL		OPERATOR
1694	Type	LogicFunc 10	ENUM		OPERATOR
1695	Output	LogicFunc 10	BOOL		OPERATOR
1696	Input A	LogicFunc 11	BOOL		OPERATOR
1697	Input B	LogicFunc 11	BOOL		OPERATOR
1698	Input C	LogicFunc 11	BOOL		OPERATOR
1699	Type	LogicFunc 11	ENUM		OPERATOR
1700	Output	LogicFunc 11	BOOL		OPERATOR
1701	Input A	LogicFunc 12	BOOL		OPERATOR
1702	Input B	LogicFunc 12	BOOL		OPERATOR
1703	Input C	LogicFunc 12	BOOL		OPERATOR
1704	Type	LogicFunc 12	ENUM		OPERATOR
1705	Output	LogicFunc 12	BOOL		OPERATOR
1706	Input A	LogicFunc 13	BOOL		OPERATOR
1707	Input B	LogicFunc 13	BOOL		OPERATOR
1708	Input C	LogicFunc 13	BOOL		OPERATOR
1709	Type	LogicFunc 13	ENUM		OPERATOR
1710	Output	LogicFunc 13	BOOL		OPERATOR
1711	Input A	LogicFunc 14	BOOL		OPERATOR
1712	Input B	LogicFunc 14	BOOL		OPERATOR

Tag	Parameter	Function Block	Type	Range	View
1713	Input C	LogicFunc 14	BOOL		OPERATOR
1714	Type	LogicFunc 14	ENUM		OPERATOR
1715	Output	LogicFunc 14	BOOL		OPERATOR
1716	Input A	LogicFunc 15	BOOL		OPERATOR
1717	Input B	LogicFunc 15	BOOL		OPERATOR
1718	Input C	LogicFunc 15	BOOL		OPERATOR
1719	Type	LogicFunc 15	ENUM		OPERATOR
1720	Output	LogicFunc 15	BOOL		OPERATOR
1721	Input A	LogicFunc 16	BOOL		OPERATOR
1722	Input B	LogicFunc 16	BOOL		OPERATOR
1723	Input C	LogicFunc 16	BOOL		OPERATOR
1724	Type	LogicFunc 16	ENUM		OPERATOR
1725	Output	LogicFunc 16	BOOL		OPERATOR
1726	Input A	LogicFunc 17	BOOL		OPERATOR
1727	Input B	LogicFunc 17	BOOL		OPERATOR
1728	Input C	LogicFunc 17	BOOL		OPERATOR
1729	Type	LogicFunc 17	ENUM		OPERATOR
1730	Output	LogicFunc 17	BOOL		OPERATOR
1731	Input A	LogicFunc 18	BOOL		OPERATOR
1732	Input B	LogicFunc 18	BOOL		OPERATOR
1733	Input C	LogicFunc 18	BOOL		OPERATOR
1734	Type	LogicFunc 18	ENUM		OPERATOR
1735	Output	LogicFunc 18	BOOL		OPERATOR
1736	Input A	LogicFunc 19	BOOL		OPERATOR
1737	Input B	LogicFunc 19	BOOL		OPERATOR
1738	Input C	LogicFunc 19	BOOL		OPERATOR
1739	Type	LogicFunc 19	ENUM		OPERATOR
1740	Output	LogicFunc 19	BOOL		OPERATOR
1741	Input A	LogicFunc 20	BOOL		OPERATOR
1742	Input B	LogicFunc 20	BOOL		OPERATOR
1743	Input C	LogicFunc 20	BOOL		OPERATOR
1744	Type	LogicFunc 20	ENUM		OPERATOR
1745	Output	LogicFunc 20	BOOL		OPERATOR
1746	Input A	LogicFunc 21	BOOL		OPERATOR
1747	Input B	LogicFunc 21	BOOL		OPERATOR
1748	Input C	LogicFunc 21	BOOL		OPERATOR
1749	Type	LogicFunc 21	ENUM		OPERATOR
1750	Output	LogicFunc 21	BOOL		OPERATOR
1751	Input A	LogicFunc 22	BOOL		OPERATOR
1752	Input B	LogicFunc 22	BOOL		OPERATOR
1753	Input C	LogicFunc 22	BOOL		OPERATOR
1754	Type	LogicFunc 22	ENUM		OPERATOR
1755	Output	LogicFunc 22	BOOL		OPERATOR
1756	Input A	LogicFunc 23	BOOL		OPERATOR
1757	Input B	LogicFunc 23	BOOL		OPERATOR
1758	Input C	LogicFunc 23	BOOL		OPERATOR

Tag	Parameter	Function Block	Type	Range	View
1759	Type	LogicFunc 23	ENUM		OPERATOR
1760	Output	LogicFunc 23	BOOL		OPERATOR
1761	Input A	LogicFunc 24	BOOL		OPERATOR
1762	Input B	LogicFunc 24	BOOL		OPERATOR
1763	Input C	LogicFunc 24	BOOL		OPERATOR
1764	Type	LogicFunc 24	ENUM		OPERATOR
1765	Output	LogicFunc 24	BOOL		OPERATOR
1766	Input A	LogicFunc 25	BOOL		OPERATOR
1767	Input B	LogicFunc 25	BOOL		OPERATOR
1768	Input C	LogicFunc 25	BOOL		OPERATOR
1769	Type	LogicFunc 25	ENUM		OPERATOR
1770	Output	LogicFunc 25	BOOL		OPERATOR
1771	Input A	LogicFunc 26	BOOL		OPERATOR
1772	Input B	LogicFunc 26	BOOL		OPERATOR
1773	Input C	LogicFunc 26	BOOL		OPERATOR
1774	Type	LogicFunc 26	ENUM		OPERATOR
1775	Output	LogicFunc 26	BOOL		OPERATOR
1776	Input A	LogicFunc 27	BOOL		OPERATOR
1777	Input B	LogicFunc 27	BOOL		OPERATOR
1778	Input C	LogicFunc 27	BOOL		OPERATOR
1779	Type	LogicFunc 27	ENUM		OPERATOR
1780	Output	LogicFunc 27	BOOL		OPERATOR
1781	Input A	LogicFunc 28	BOOL		OPERATOR
1782	Input B	LogicFunc 28	BOOL		OPERATOR
1783	Input C	LogicFunc 28	BOOL		OPERATOR
1784	Type	LogicFunc 28	ENUM		OPERATOR
1785	Output	LogicFunc 28	BOOL		OPERATOR
1786	Input A	LogicFunc 29	BOOL		OPERATOR
1787	Input B	LogicFunc 29	BOOL		OPERATOR
1788	Input C	LogicFunc 29	BOOL		OPERATOR
1789	Type	LogicFunc 29	ENUM		OPERATOR
1790	Output	LogicFunc 29	BOOL		OPERATOR
1791	Input A	LogicFunc 30	BOOL		OPERATOR
1792	Input B	LogicFunc 30	BOOL		OPERATOR
1793	Input C	LogicFunc 30	BOOL		OPERATOR
1794	Type	LogicFunc 30	ENUM		OPERATOR
1795	Output	LogicFunc 30	BOOL		OPERATOR
1796	Input	Minimum Speed	REAL	-300.0 to 300.0 %	OPERATOR
1797	Minimum	Minimum Speed	REAL	-100.0 to 100.0 %	OPERATOR
1798	Mode	Minimum Speed	ENUM		OPERATOR
1799	Output	Minimum Speed	REAL		OPERATOR
1800	Input 0	Multiplexer 1	BIT		OPERATOR
1801	Input 1	Multiplexer 1	BIT		OPERATOR
1802	Input 2	Multiplexer 1	BIT		OPERATOR
1803	Input 3	Multiplexer 1	BIT		OPERATOR
1804	Input 4	Multiplexer 1	BIT		OPERATOR

Tag	Parameter	Function Block	Type	Range	View
1805	Input 5	Multiplexer 1	BIT		OPERATOR
1806	Input 6	Multiplexer 1	BIT		OPERATOR
1807	Input 7	Multiplexer 1	BIT		OPERATOR
1808	Input 8	Multiplexer 1	BIT		OPERATOR
1809	Input 9	Multiplexer 1	BIT		OPERATOR
1810	Input 10	Multiplexer 1	BIT		OPERATOR
1811	Input 11	Multiplexer 1	BIT		OPERATOR
1812	Input 12	Multiplexer 1	BIT		OPERATOR
1813	Input 13	Multiplexer 1	BIT		OPERATOR
1814	Input 14	Multiplexer 1	BIT		OPERATOR
1815	Input 15	Multiplexer 1	BIT		OPERATOR
1816	Output	Multiplexer 1	WORD		OPERATOR
1817	Input 0	Multiplexer 2	BIT		OPERATOR
1818	Input 1	Multiplexer 2	BIT		OPERATOR
1819	Input 2	Multiplexer 2	BIT		OPERATOR
1820	Input 3	Multiplexer 2	BIT		OPERATOR
1821	Input 4	Multiplexer 2	BIT		OPERATOR
1822	Input 5	Multiplexer 2	BIT		OPERATOR
1823	Input 6	Multiplexer 2	BIT		OPERATOR
1824	Input 7	Multiplexer 2	BIT		OPERATOR
1825	Input 8	Multiplexer 2	BIT		OPERATOR
1826	Input 9	Multiplexer 2	BIT		OPERATOR
1827	Input 10	Multiplexer 2	BIT		OPERATOR
1828	Input 11	Multiplexer 2	BIT		OPERATOR
1829	Input 12	Multiplexer 2	BIT		OPERATOR
1830	Input 13	Multiplexer 2	BIT		OPERATOR
1831	Input 14	Multiplexer 2	BIT		OPERATOR
1832	Input 15	Multiplexer 2	BIT		OPERATOR
1833	Output	Multiplexer 2	WORD		OPERATOR
1834	Stage Select	Multi-Stage Speed	USINT	0 to 15	OPERATOR
1835	Stage Mode	Multi-Stage Speed	BOOL		OPERATOR
1836	Speed	Multi-Stage Speed	REAL	0.0 to 300.0 %	OPERATOR
1852	Reverse	Multi-Stage Speed	BOOL		OPERATOR
1868	Accel Time	Multi-Stage Speed	REAL	0.0 to 3000.0 s	OPERATOR
1884	Decel Time	Multi-Stage Speed	REAL	0.0 to 3000.0 s	OPERATOR
1900	Speed Output	Multi-Stage Speed	REAL		OPERATOR
1901	Reverse Output	Multi-Stage Speed	BOOL		OPERATOR
1902	Accel Time OP	Multi-Stage Speed	REAL		OPERATOR
1903	Decel Time OP	Multi-Stage Speed	REAL		OPERATOR
1904	Setpoint	PID 1	REAL	-300.0 to 300.0 %	OPERATOR
1905	Feedback	PID 1	REAL	-300.0 to 300.0 %	OPERATOR
1906	Feed Fwd	PID 1	REAL	-300.0 to 300.0 %	OPERATOR
1907	Feedback Gain	PID 1	REAL	-10.0 to 10.0	OPERATOR
1908	Feed Fwd Gain	PID 1	REAL	-10.0 to 10.0	OPERATOR
1909	P Gain	PID 1	REAL	0.0 to 100.0	OPERATOR
1910	I Gain	PID 1	REAL	0.0 to 100.0	OPERATOR

Tag	Parameter	Function Block	Type	Range	View
1911	D Gain	PID 1	REAL	0.0 to 100.0	OPERATOR
1912	Limit	PID 1	REAL	0.0 to 300.0 %	OPERATOR
1913	Enable PID	PID 1	BOOL		OPERATOR
1914	Integral Defeat	PID 1	BOOL		OPERATOR
1915	D Filter TC	PID 1	REAL	0.05 to 5.0 s	OPERATOR
1916	Output Scaling	PID 1	REAL	-3.0 to 3.0	OPERATOR
1917	Low Limit	PID 1	REAL	-300.0 to 0.0 %	OPERATOR
1918	Symmetric Limit	PID 1	BOOL		OPERATOR
1919	Output	PID 1	REAL		OPERATOR
1920	Error	PID 1	REAL		OPERATOR
1921	Limiting	PID 1	BOOL		OPERATOR
1922	Setpoint	PID 2	REAL	-300.0 to 300.0 %	OPERATOR
1923	Feedback	PID 2	REAL	-300.0 to 300.0 %	OPERATOR
1924	Feed Fwd	PID 2	REAL	-300.0 to 300.0 %	OPERATOR
1925	Feedback Gain	PID 2	REAL	-10.0 to 10.0	OPERATOR
1926	Feed Fwd Gain	PID 2	REAL	-10.0 to 10.0	OPERATOR
1927	P Gain	PID 2	REAL	0.0 to 100.0	OPERATOR
1928	I Gain	PID 2	REAL	0.0 to 100.0	OPERATOR
1929	D Gain	PID 2	REAL	0.0 to 100.0	OPERATOR
1930	Limit	PID 2	REAL	0.0 to 300.0 %	OPERATOR
1931	Enable PID	PID 2	BOOL		OPERATOR
1932	Integral Defeat	PID 2	BOOL		OPERATOR
1933	D Filter TC	PID 2	REAL	0.05 to 5.0 s	OPERATOR
1934	Output Scaling	PID 2	REAL	-3.0 to 3.0	OPERATOR
1935	Low Limit	PID 2	REAL	-300.0 to 0.0 %	OPERATOR
1936	Symmetric Limit	PID 2	BOOL		OPERATOR
1937	Output	PID 2	REAL		OPERATOR
1938	Error	PID 2	REAL		OPERATOR
1939	Limiting	PID 2	BOOL		OPERATOR
1940	Select Input	Preset 1	ENUM		OPERATOR
1941	Input 0	Preset 1	REAL	-32768.0 to 32767.0	OPERATOR
1942	Input 1	Preset 1	REAL	-32768.0 to 32767.0	OPERATOR
1943	Input 2	Preset 1	REAL	-32768.0 to 32767.0	OPERATOR
1944	Input 3	Preset 1	REAL	-32768.0 to 32767.0	OPERATOR
1945	Input 4	Preset 1	REAL	-32768.0 to 32767.0	OPERATOR
1946	Input 5	Preset 1	REAL	-32768.0 to 32767.0	OPERATOR
1947	Input 6	Preset 1	REAL	-32768.0 to 32767.0	OPERATOR
1948	Input 7	Preset 1	REAL	-32768.0 to 32767.0	OPERATOR
1949	Output 1	Preset 1	REAL		OPERATOR
1950	Output 2	Preset 1	REAL		OPERATOR
1951	Select Input	Preset 1	ENUM		OPERATOR
1952	Input 0	Preset 2	REAL	-32768.0 to 32767.0	OPERATOR
1953	Input 1	Preset 2	REAL	-32768.0 to 32767.0	OPERATOR
1954	Input 2	Preset 2	REAL	-32768.0 to 32767.0	OPERATOR
1955	Input 3	Preset 2	REAL	-32768.0 to 32767.0	OPERATOR
1956	Input 4	Preset 2	REAL	-32768.0 to 32767.0	OPERATOR

Tag	Parameter	Function Block	Type	Range	View
1957	Input 5	Preset 2	REAL	-32768.0 to 32767.0	OPERATOR
1958	Input 6	Preset 2	REAL	-32768.0 to 32767.0	OPERATOR
1959	Input 7	Preset 2	REAL	-32768.0 to 32767.0	OPERATOR
1960	Output 1	Preset 2	REAL		OPERATOR
1961	Output 2	Preset 2	REAL		OPERATOR
1962	Select Input	Preset 2	ENUM		OPERATOR
1963	Input 0	Preset 3	REAL	-32768.0 to 32767.0	OPERATOR
1964	Input 1	Preset 3	REAL	-32768.0 to 32767.0	OPERATOR
1965	Input 2	Preset 3	REAL	-32768.0 to 32767.0	OPERATOR
1966	Input 3	Preset 3	REAL	-32768.0 to 32767.0	OPERATOR
1967	Input 4	Preset 3	REAL	-32768.0 to 32767.0	OPERATOR
1968	Input 5	Preset 3	REAL	-32768.0 to 32767.0	OPERATOR
1969	Input 6	Preset 3	REAL	-32768.0 to 32767.0	OPERATOR
1970	Input 7	Preset 3	REAL	-32768.0 to 32767.0	OPERATOR
1971	Output 1	Preset 3	REAL		OPERATOR
1972	Output 2	Preset 3	REAL		OPERATOR
1973	Select Input	Preset 4	ENUM		OPERATOR
1974	Input 0	Preset 4	REAL	-32768.0 to 32767.0	OPERATOR
1975	Input 1	Preset 4	REAL	-32768.0 to 32767.0	OPERATOR
1976	Input 2	Preset 4	REAL	-32768.0 to 32767.0	OPERATOR
1977	Input 3	Preset 4	REAL	-32768.0 to 32767.0	OPERATOR
1978	Input 4	Preset 4	REAL	-32768.0 to 32767.0	OPERATOR
1979	Input 5	Preset 4	REAL	-32768.0 to 32767.0	OPERATOR
1980	Input 6	Preset 4	REAL	-32768.0 to 32767.0	OPERATOR
1981	Input 7	Preset 4	REAL	-32768.0 to 32767.0	OPERATOR
1982	Output 1	Preset 4	REAL		OPERATOR
1983	Output 2	Preset 4	REAL		OPERATOR
1984	Select Input	Preset 5	ENUM		OPERATOR
1985	Input 0	Preset 5	REAL	-32768.0 to 32767.0	OPERATOR
1986	Input 1	Preset 5	REAL	-32768.0 to 32767.0	OPERATOR
1987	Input 2	Preset 5	REAL	-32768.0 to 32767.0	OPERATOR
1988	Input 3	Preset 5	REAL	-32768.0 to 32767.0	OPERATOR
1989	Input 4	Preset 5	REAL	-32768.0 to 32767.0	OPERATOR
1990	Input 5	Preset 5	REAL	-32768.0 to 32767.0	OPERATOR
1991	Input 6	Preset 5	REAL	-32768.0 to 32767.0	OPERATOR
1992	Input 7	Preset 5	REAL	-32768.0 to 32767.0	OPERATOR
1993	Output 1	Preset 5	REAL		OPERATOR
1994	Output 2	Preset 5	REAL		OPERATOR
1995	Select Input	Preset 6	ENUM		OPERATOR
1996	Input 0	Preset 6	REAL	-32768.0 to 32767.0	OPERATOR
1997	Input 1	Preset 6	REAL	-32768.0 to 32767.0	OPERATOR
1998	Input 2	Preset 6	REAL	-32768.0 to 32767.0	OPERATOR
1999	Input 3	Preset 6	REAL	-32768.0 to 32767.0	OPERATOR
2000	Input 4	Preset 6	REAL	-32768.0 to 32767.0	OPERATOR
2001	Input 5	Preset 6	REAL	-32768.0 to 32767.0	OPERATOR
2002	Input 6	Preset 6	REAL	-32768.0 to 32767.0	OPERATOR

Tag	Parameter	Function Block	Type	Range	View
2003	Input 7	Preset 6	REAL	-32768.0 to 32767.0	OPERATOR
2004	Output 1	Preset 6	REAL		OPERATOR
2005	Output 2	Preset 6	REAL		OPERATOR
2006	Select Input	Preset 7	ENUM		OPERATOR
2007	Input 0	Preset 7	REAL	-32768.0 to 32767.0	OPERATOR
2008	Input 1	Preset 7	REAL	-32768.0 to 32767.0	OPERATOR
2009	Input 2	Preset 7	REAL	-32768.0 to 32767.0	OPERATOR
2010	Input 3	Preset 7	REAL	-32768.0 to 32767.0	OPERATOR
2011	Input 4	Preset 7	REAL	-32768.0 to 32767.0	OPERATOR
2012	Input 5	Preset 7	REAL	-32768.0 to 32767.0	OPERATOR
2013	Input 6	Preset 7	REAL	-32768.0 to 32767.0	OPERATOR
2014	Input 7	Preset 7	REAL	-32768.0 to 32767.0	OPERATOR
2015	Output 1	Preset 7	REAL		OPERATOR
2016	Output 2	Preset 7	REAL		OPERATOR
2017	Select Input	Preset 8	ENUM		OPERATOR
2018	Input 0	Preset 8	REAL	-32768.0 to 32767.0	OPERATOR
2019	Input 1	Preset 8	REAL	-32768.0 to 32767.0	OPERATOR
2020	Input 2	Preset 8	REAL	-32768.0 to 32767.0	OPERATOR
2021	Input 3	Preset 8	REAL	-32768.0 to 32767.0	OPERATOR
2022	Input 4	Preset 8	REAL	-32768.0 to 32767.0	OPERATOR
2023	Input 5	Preset 8	REAL	-32768.0 to 32767.0	OPERATOR
2024	Input 6	Preset 8	REAL	-32768.0 to 32767.0	OPERATOR
2025	Input 7	Preset 8	REAL	-32768.0 to 32767.0	OPERATOR
2026	Output 1	Preset 8	REAL		OPERATOR
2027	Output 2	Preset 8	REAL		OPERATOR
2028	Raise Input	Preset 4	BOOL		OPERATOR
2029	Lower Input	Preset 4	BOOL		OPERATOR
2030	Ramp Rate	Raise/Lower	REAL	0.0 to 600.0 s	OPERATOR
2031	Max Value	Raise/Lower	REAL	-100.0 to 100.0 %	OPERATOR
2032	Min Value	Raise/Lower	REAL	-100.0 to 100.0 %	OPERATOR
2033	Reset Value	Raise/Lower	REAL	-100.0 to 100.0 %	OPERATOR
2034	Reset	Raise/Lower	BOOL		OPERATOR
2035	Output	Raise/Lower	REAL	-32768.0 to 32767.0 %	OPERATOR
2036	Input	Skip Frequencies	REAL	-300.0 to 300.0 %	OPERATOR
2037	Band 1	Skip Frequencies	REAL	0.0 to 60.0 Hz	OPERATOR
2038	Frequency 1	Skip Frequencies	REAL	0.0 to 300.0 Hz	OPERATOR
2039	Band 2	Skip Frequencies	REAL	0.0 to 60.0 Hz	OPERATOR
2040	Frequency 2	Skip Frequencies	REAL	0.0 to 300.0 Hz	OPERATOR
2041	Output	Skip Frequencies	REAL		OPERATOR
2042	Enable	Timer 1	BOOL		OPERATOR
2043	Reset	Timer 1	BOOL		OPERATOR
2044	Reset Value	Timer 1	DINT	0 to s	OPERATOR
2045	Scale	Timer 1	DINT	1 to	OPERATOR
2046	Threshold	Timer 1	DINT		OPERATOR
2047	Above Threshold	Timer 1	BOOL		OPERATOR
2048	Scaled Time	Timer 1	REAL		OPERATOR

Tag	Parameter	Function Block	Type	Range	View
2049	Total Hours	Timer 1	DINT	0 to	OPERATOR
2050	Total Seconds	Timer 1	DINT		OPERATOR
2051	Enable	Timer 2	BOOL		OPERATOR
2052	Reset	Timer 2	BOOL		OPERATOR
2053	Reset Value	Timer 2	DINT	0 to s	OPERATOR
2054	Scale	Timer 2	DINT	1 to	OPERATOR
2055	Threshold	Timer 2	DINT		OPERATOR
2056	Above Threshold	Timer 2	BOOL		OPERATOR
2057	Scaled Time	Timer 2	REAL		OPERATOR
2058	Total Hours	Timer 2	DINT	0 to	OPERATOR
2059	Total Seconds	Timer 2	DINT		OPERATOR
2060	Input A	Value Func 1	REAL	-2147483.5 to 2147483.5	OPERATOR
2061	Input B	Value Func 1	REAL	-2147483.5 to 2147483.5	OPERATOR
2062	Input C	Value Func 1	REAL	-2147483.5 to 2147483.5	OPERATOR
2063	Type	Value Func 1	ENUM		OPERATOR
2064	Output	Value Func 1	REAL	-2147483.5 to 2147483.5	OPERATOR
2065	Input A	Value Func 2	REAL	-2147483.5 to 2147483.5	OPERATOR
2066	Input B	Value Func 2	REAL	-2147483.5 to 2147483.5	OPERATOR
2067	Input C	Value Func 2	REAL	-2147483.5 to 2147483.5	OPERATOR
2068	Type	Value Func 2	ENUM		OPERATOR
2069	Output	Value Func 2	REAL	-2147483.5 to 2147483.5	OPERATOR
2070	Input A	Value Func 3	REAL	-2147483.5 to 2147483.5	OPERATOR
2071	Input B	Value Func 3	REAL	-2147483.5 to 2147483.5	OPERATOR
2072	Input C	Value Func 3	REAL	-2147483.5 to 2147483.5	OPERATOR
2073	Type	Value Func 3	ENUM		OPERATOR
2074	Output	Value Func 3	REAL	-2147483.5 to 2147483.5	OPERATOR
2075	Input A	Value Func 4	REAL	-2147483.5 to 2147483.5	OPERATOR
2076	Input B	Value Func 4	REAL	-2147483.5 to 2147483.5	OPERATOR
2077	Input C	Value Func 4	REAL	-2147483.5 to 2147483.5	OPERATOR
2078	Type	Value Func 4	ENUM		OPERATOR
2079	Output	Value Func 4	REAL	-2147483.5 to 2147483.5	OPERATOR
2080	Input A	Value Func 5	REAL	-2147483.5 to 2147483.5	OPERATOR
2081	Input B	Value Func 5	REAL	-2147483.5 to 2147483.5	OPERATOR
2082	Input C	Value Func 5	REAL	-2147483.5 to 2147483.5	OPERATOR
2083	Type	Value Func 5	ENUM		OPERATOR
2084	Output	Value Func 5	REAL	-2147483.5 to 2147483.5	OPERATOR
2085	Input A	Value Func 6	REAL	-2147483.5 to 2147483.5	OPERATOR
2086	Input B	Value Func 6	REAL	-2147483.5 to 2147483.5	OPERATOR
2087	Input C	Value Func 6	REAL	-2147483.5 to 2147483.5	OPERATOR

Tag	Parameter	Function Block	Type	Range	View
2088	Type	Value Func 6	ENUM		OPERATOR
2089	Output	Value Func 6	REAL	-2147483.5 to 2147483.5	OPERATOR
2090	Input A	Value Func 7	REAL	-2147483.5 to 2147483.5	OPERATOR
2091	Input B	Value Func 7	REAL	-2147483.5 to 2147483.5	OPERATOR
2092	Input C	Value Func 7	REAL	-2147483.5 to 2147483.5	OPERATOR
2093	Type	Value Func 7	ENUM		OPERATOR
2094	Output	Value Func 7	REAL	-2147483.5 to 2147483.5	OPERATOR
2095	Input A	Value Func 8	REAL	-2147483.5 to 2147483.5	OPERATOR
2096	Input B	Value Func 8	REAL	-2147483.5 to 2147483.5	OPERATOR
2097	Input C	Value Func 8	REAL	-2147483.5 to 2147483.5	OPERATOR
2098	Type	Value Func 8	ENUM		OPERATOR
2099	Output	Value Func 8	REAL	-2147483.5 to 2147483.5	OPERATOR
2100	Input A	Value Func 9	REAL	-2147483.5 to 2147483.5	OPERATOR
2101	Input B	Value Func 9	REAL	-2147483.5 to 2147483.5	OPERATOR
2102	Input C	Value Func 9	REAL	-2147483.5 to 2147483.5	OPERATOR
2103	Type	Value Func 9	ENUM		OPERATOR
2104	Output	Value Func 9	REAL	-2147483.5 to 2147483.5	OPERATOR
2105	Input A	Value Func 10	REAL	-2147483.5 to 2147483.5	OPERATOR
2106	Input B	Value Func 10	REAL	-2147483.5 to 2147483.5	OPERATOR
2107	Input C	Value Func 10	REAL	-2147483.5 to 2147483.5	OPERATOR
2108	Type	Value Func 10	ENUM		OPERATOR
2109	Output	Value Func 10	REAL	-2147483.5 to 2147483.5	OPERATOR
2110	Input A	Value Func 11	REAL	-2147483.5 to 2147483.5	OPERATOR
2111	Input B	Value Func 11	REAL	-2147483.5 to 2147483.5	OPERATOR
2112	Input C	Value Func 11	REAL	-2147483.5 to 2147483.5	OPERATOR
2113	Type	Value Func 11	ENUM		OPERATOR
2114	Output	Value Func 11	REAL	-2147483.5 to 2147483.5	OPERATOR
2115	Input A	Value Func 12	REAL	-2147483.5 to 2147483.5	OPERATOR
2116	Input B	Value Func 12	REAL	-2147483.5 to 2147483.5	OPERATOR
2117	Input C	Value Func 12	REAL	-2147483.5 to 2147483.5	OPERATOR
2118	Type	Value Func 12	ENUM		OPERATOR
2119	Output	Value Func 12	REAL	-2147483.5 to 2147483.5	OPERATOR
2120	Input A	Value Func 13	REAL	-2147483.5 to 2147483.5	OPERATOR
2121	Input B	Value Func 13	REAL	-2147483.5 to 2147483.5	OPERATOR
2122	Input C	Value Func 13	REAL	-2147483.5 to 2147483.5	OPERATOR
2123	Type	Value Func 13	ENUM		OPERATOR

Tag	Parameter	Function Block	Type	Range	View
2124	Output	Value Func 13	REAL	-2147483.5 to 2147483.5	OPERATOR
2125	Input A	Value Func 14	REAL	-2147483.5 to 2147483.5	OPERATOR
2126	Input B	Value Func 14	REAL	-2147483.5 to 2147483.5	OPERATOR
2127	Input C	Value Func 14	REAL	-2147483.5 to 2147483.5	OPERATOR
2128	Type	Value Func 14	ENUM		OPERATOR
2129	Output	Value Func 14	REAL	-2147483.5 to 2147483.5	OPERATOR
2130	Input A	Value Func 15	REAL	-2147483.5 to 2147483.5	OPERATOR
2131	Input B	Value Func 15	REAL	-2147483.5 to 2147483.5	OPERATOR
2132	Input C	Value Func 15	REAL	-2147483.5 to 2147483.5	OPERATOR
2133	Type	Value Func 15	ENUM		OPERATOR
2134	Output	Value Func 15	REAL	-2147483.5 to 2147483.5	OPERATOR
2135	Input A	Value Func 16	REAL	-2147483.5 to 2147483.5	OPERATOR
2136	Input B	Value Func 16	REAL	-2147483.5 to 2147483.5	OPERATOR
2137	Input C	Value Func 16	REAL	-2147483.5 to 2147483.5	OPERATOR
2138	Type	Value Func 16	ENUM		OPERATOR
2139	Output	Value Func 16	REAL	-2147483.5 to 2147483.5	OPERATOR
2140	Input A	Value Func 17	REAL	-2147483.5 to 2147483.5	OPERATOR
2141	Input B	Value Func 17	REAL	-2147483.5 to 2147483.5	OPERATOR
2142	Input C	Value Func 17	REAL	-2147483.5 to 2147483.5	OPERATOR
2143	Type	Value Func 17	ENUM		OPERATOR
2144	Output	Value Func 17	REAL	-2147483.5 to 2147483.5	OPERATOR
2145	Input A	Value Func 18	REAL	-2147483.5 to 2147483.5	OPERATOR
2146	Input B	Value Func 18	REAL	-2147483.5 to 2147483.5	OPERATOR
2147	Input C	Value Func 18	REAL	-2147483.5 to 2147483.5	OPERATOR
2148	Type	Value Func 18	ENUM		OPERATOR
2149	Output	Value Func 18	REAL	-2147483.5 to 2147483.5	OPERATOR
2150	Input A	Value Func 19	REAL	-2147483.5 to 2147483.5	OPERATOR
2151	Input B	Value Func 19	REAL	-2147483.5 to 2147483.5	OPERATOR
2152	Input C	Value Func 19	REAL	-2147483.5 to 2147483.5	OPERATOR
2153	Type	Value Func 19	ENUM		OPERATOR
2154	Output	Value Func 19	REAL	-2147483.5 to 2147483.5	OPERATOR
2155	Input A	Value Func 20	REAL	-2147483.5 to 2147483.5	OPERATOR
2156	Input B	Value Func 20	REAL	-2147483.5 to 2147483.5	OPERATOR
2157	Input C	Value Func 20	REAL	-2147483.5 to 2147483.5	OPERATOR
2158	Type	Value Func 20	ENUM		OPERATOR
2159	Output	Value Func 20	REAL	-2147483.5 to 2147483.5	OPERATOR

Tag	Parameter	Function Block	Type	Range	View
2160	Input A	Value Func 21	REAL	-2147483.5 to 2147483.5	OPERATOR
2161	Input B	Value Func 21	REAL	-2147483.5 to 2147483.5	OPERATOR
2162	Input C	Value Func 21	REAL	-2147483.5 to 2147483.5	OPERATOR
2163	Type	Value Func 21	ENUM		OPERATOR
2164	Output	Value Func 21	REAL	-2147483.5 to 2147483.5	OPERATOR
2165	Input A	Value Func 22	REAL	-2147483.5 to 2147483.5	OPERATOR
2166	Input B	Value Func 22	REAL	-2147483.5 to 2147483.5	OPERATOR
2167	Input C	Value Func 22	REAL	-2147483.5 to 2147483.5	OPERATOR
2168	Type	Value Func 22	ENUM		OPERATOR
2169	Output	Value Func 22	REAL	-2147483.5 to 2147483.5	OPERATOR
2170	Input A	Value Func 23	REAL	-2147483.5 to 2147483.5	OPERATOR
2171	Input B	Value Func 23	REAL	-2147483.5 to 2147483.5	OPERATOR
2172	Input C	Value Func 23	REAL	-2147483.5 to 2147483.5	OPERATOR
2173	Type	Value Func 23	ENUM		OPERATOR
2174	Output	Value Func 23	REAL	-2147483.5 to 2147483.5	OPERATOR
2175	Input A	Value Func 24	REAL	-2147483.5 to 2147483.5	OPERATOR
2176	Input B	Value Func 24	REAL	-2147483.5 to 2147483.5	OPERATOR
2177	Input C	Value Func 24	REAL	-2147483.5 to 2147483.5	OPERATOR
2178	Type	Value Func 24	ENUM		OPERATOR
2179	Output	Value Func 24	REAL	-2147483.5 to 2147483.5	OPERATOR
2180	Input A	Value Func 25	REAL	-2147483.5 to 2147483.5	OPERATOR
2181	Input B	Value Func 25	REAL	-2147483.5 to 2147483.5	OPERATOR
2182	Input C	Value Func 25	REAL	-2147483.5 to 2147483.5	OPERATOR
2183	Type	Value Func 25	ENUM		OPERATOR
2184	Output	Value Func 25	REAL	-2147483.5 to 2147483.5	OPERATOR
2185	Input A	Value Func 26	REAL	-2147483.5 to 2147483.5	OPERATOR
2186	Input B	Value Func 26	REAL	-2147483.5 to 2147483.5	OPERATOR
2187	Input C	Value Func 26	REAL	-2147483.5 to 2147483.5	OPERATOR
2188	Type	Value Func 26	ENUM		OPERATOR
2189	Output	Value Func 26	REAL	-2147483.5 to 2147483.5	OPERATOR
2190	Input A	Value Func 27	REAL	-2147483.5 to 2147483.5	OPERATOR
2191	Input B	Value Func 27	REAL	-2147483.5 to 2147483.5	OPERATOR
2192	Input C	Value Func 27	REAL	-2147483.5 to 2147483.5	OPERATOR
2193	Type	Value Func 27	ENUM		OPERATOR
2194	Output	Value Func 27	REAL	-2147483.5 to 2147483.5	OPERATOR
2195	Input A	Value Func 28	REAL	-2147483.5 to 2147483.5	OPERATOR

Tag	Parameter	Function Block	Type	Range	View
2196	Input B	Value Func 28	REAL	-2147483.5 to 2147483.5	OPERATOR
2197	Input C	Value Func 28	REAL	-2147483.5 to 2147483.5	OPERATOR
2198	Type	Value Func 28	ENUM		OPERATOR
2199	Output	Value Func 28	REAL	-2147483.5 to 2147483.5	OPERATOR
2200	Input A	Value Func 29	REAL	-2147483.5 to 2147483.5	OPERATOR
2201	Input B	Value Func 29	REAL	-2147483.5 to 2147483.5	OPERATOR
2202	Input C	Value Func 29	REAL	-2147483.5 to 2147483.5	OPERATOR
2203	Type	Value Func 29	ENUM		OPERATOR
2204	Output	Value Func 29	REAL	-2147483.5 to 2147483.5	OPERATOR
2205	Input A	Value Func 30	REAL	-2147483.5 to 2147483.5	OPERATOR
2206	Input B	Value Func 30	REAL	-2147483.5 to 2147483.5	OPERATOR
2207	Input C	Value Func 30	REAL	-2147483.5 to 2147483.5	OPERATOR
2208	Type	Value Func 30	ENUM		OPERATOR
2209	Output	Value Func 30	REAL	-2147483.5 to 2147483.5	OPERATOR
2210	Input A	Value Func 31	REAL	-2147483.5 to 2147483.5	OPERATOR
2211	Input B	Value Func 31	REAL	-2147483.5 to 2147483.5	OPERATOR
2212	Input C	Value Func 31	REAL	-2147483.5 to 2147483.5	OPERATOR
2213	Type	Value Func 31	ENUM		OPERATOR
2214	Output	Value Func 31	REAL	-2147483.5 to 2147483.5	OPERATOR
2215	Input A	Value Func 32	REAL	-2147483.5 to 2147483.5	OPERATOR
2216	Input B	Value Func 32	REAL	-2147483.5 to 2147483.5	OPERATOR
2217	Input C	Value Func 32	REAL	-2147483.5 to 2147483.5	OPERATOR
2218	Type	Value Func 32	ENUM		OPERATOR
2219	Output	Value Func 32	REAL	-2147483.5 to 2147483.5	OPERATOR
2220	Input A	Value Func 33	REAL	-2147483.5 to 2147483.5	OPERATOR
2221	Input B	Value Func 33	REAL	-2147483.5 to 2147483.5	OPERATOR
2222	Input C	Value Func 33	REAL	-2147483.5 to 2147483.5	OPERATOR
2223	Type	Value Func 33	ENUM		OPERATOR
2224	Output	Value Func 33	REAL	-2147483.5 to 2147483.5	OPERATOR
2225	Input A	Value Func 34	REAL	-2147483.5 to 2147483.5	OPERATOR
2226	Input B	Value Func 34	REAL	-2147483.5 to 2147483.5	OPERATOR
2227	Input C	Value Func 34	REAL	-2147483.5 to 2147483.5	OPERATOR
2228	Type	Value Func 34	ENUM		OPERATOR
2229	Output	Value Func 34	REAL	-2147483.5 to 2147483.5	OPERATOR
2230	Input A	Value Func 35	REAL	-2147483.5 to 2147483.5	OPERATOR
2231	Input B	Value Func 35	REAL	-2147483.5 to 2147483.5	OPERATOR

Tag	Parameter	Function Block	Type	Range	View
2232	Input C	Value Func 35	REAL	-2147483.5 to 2147483.5	OPERATOR
2233	Type	Value Func 35	ENUM		OPERATOR
2234	Output	Value Func 35	REAL	-2147483.5 to 2147483.5	OPERATOR
2235	Input A	Value Func 36	REAL	-2147483.5 to 2147483.5	OPERATOR
2236	Input B	Value Func 36	REAL	-2147483.5 to 2147483.5	OPERATOR
2237	Input C	Value Func 36	REAL	-2147483.5 to 2147483.5	OPERATOR
2238	Type	Value Func 36	ENUM		OPERATOR
2239	Output	Value Func 36	REAL	-2147483.5 to 2147483.5	OPERATOR
2240	Input A	Value Func 37	REAL	-2147483.5 to 2147483.5	OPERATOR
2241	Input B	Value Func 37	REAL	-2147483.5 to 2147483.5	OPERATOR
2242	Input C	Value Func 37	REAL	-2147483.5 to 2147483.5	OPERATOR
2243	Type	Value Func 37	ENUM		OPERATOR
2244	Output	Value Func 37	REAL	-2147483.5 to 2147483.5	OPERATOR
2245	Input A	Value Func 38	REAL	-2147483.5 to 2147483.5	OPERATOR
2246	Input B	Value Func 38	REAL	-2147483.5 to 2147483.5	OPERATOR
2247	Input C	Value Func 38	REAL	-2147483.5 to 2147483.5	OPERATOR
2248	Type	Value Func 38	ENUM		OPERATOR
2249	Output	Value Func 38	REAL	-2147483.5 to 2147483.5	OPERATOR
2250	Input A	Value Func 39	REAL	-2147483.5 to 2147483.5	OPERATOR
2251	Input B	Value Func 39	REAL	-2147483.5 to 2147483.5	OPERATOR
2252	Input C	Value Func 39	REAL	-2147483.5 to 2147483.5	OPERATOR
2253	Type	Value Func 39	ENUM		OPERATOR
2254	Output	Value Func 39	REAL	-2147483.5 to 2147483.5	OPERATOR
2255	Input A	Value Func 40	REAL	-2147483.5 to 2147483.5	OPERATOR
2256	Input B	Value Func 40	REAL	-2147483.5 to 2147483.5	OPERATOR
2257	Input C	Value Func 40	REAL	-2147483.5 to 2147483.5	OPERATOR
2258	Type	Value Func 40	ENUM		OPERATOR
2259	Output	Value Func 40	REAL	-2147483.5 to 2147483.5	OPERATOR
2260	Hysteresis	Zero Speed	REAL	0.0 to 300.0 %	OPERATOR
2261	Threshold	Zero Speed	REAL	0.0 to 300.0 %	OPERATOR
2262	At Zero Speed	Zero Speed	BOOL		OPERATOR
2442	Precharge State	Feedbacks	ENUM		ENGINEER
2443	PwrI Threshold V	Power Loss	REAL		TECHNICIAN
2444	PwrI Ctrl Band V	Power Loss	REAL		TECHNICIAN
2524	Inj Active	Inj Braking	BOOL		TECHNICIAN
2525	Fly Active	Flycatching	BOOL		TECHNICIAN
2526	Atn Active	Autotune	BOOL		TECHNICIAN
2537	Active Alert	Trips Status	ENUM		OPERATOR
2538	Nom. fPWM Thres.	PatternGen (PWM)	REAL	0 to 550 Hz	TECHNICIAN

Tag	Parameter	Function Block	Type	Range	View
2539	Nominal fPWM On	PatternGen (PWM)	BOOL		TECHNICIAN
2546	Speed Demand RPM	Reference	REAL	100000 to 1500 rpm	OPERATOR
2547	Speed Demand Hz	Reference	REAL	60000 to 50 Hz	OPERATOR
2552	IM Motor Name	Motor Nameplate (IM)	STRING		TECHNICIAN
2563	Atn Last Alert	Autotune	ENUM		OPERATOR
2567	Enc Pos div1000	Encoder	REAL	-2147483.5 to +2147483.5	TECHNICIAN
2568	Enc2 Pos div1000	Encoder 2	REAL	-2147483.5 to +2147483.5	TECHNICIAN
2573	PMAC Motor Name	PMAC Motor Data	STRING		TECHNICIAN
2584	Atn Mag I UsrEna	Autotune	BOOL		TECHNICIAN

APPENDIX D: Application Macros

13.3 Overview

The AC15 has 6 preconfigured application (macro) templates. The macros may be selected using the drive keypad, but also may be configured using DSE Lite.

Macro 1 (V1_STD.A15)	Basic Speed Control template for AC15
Macro 2 (V1_AM.A15)	Auto / Manual Control template for AC15
Macro 3 (V1_PRST.A15)	Preset Speeds Control template for AC15
Macro 4 (V1_RL.A15)	Raise / Lower Control template for AC15
Macro 5 (V1_PID.A15)	PID Control template for AC15
Macro 6 (V1_AUXCOMMS.A15)	Aux Comms Control template for AC15

The required terminal wiring for each macro/template may be found in the manual DOC-0017-03 'AC15 Series Hardware Installation Manual: Frames 1-5'

To load a macro from the AC15 Keypad or optional 6901 MMI, the macro must first be selected, and then loaded. Navigate to the Setup Menu, followed by the Application Menu, and select the first parameter **1150 Application**. Press M to allow modification. A setting of 1 selects Macro 1 (Standard) etc. Press E to exit one menu level, then scroll down to parameter **1151 Load Application**. Press M to allow modification. A setting of 1 (True) will load the selected application when pressing E to exit. When the macro has been successfully loaded, the keypad will display "AL23" (AC15 Keypad) or "App Loaded" (6901). When a parameter save has been completed, either manually or automatically dependent on the setting of Parameter **0928 Enable Auto Save**, parameter 1150 Application will display 9 (Saved).

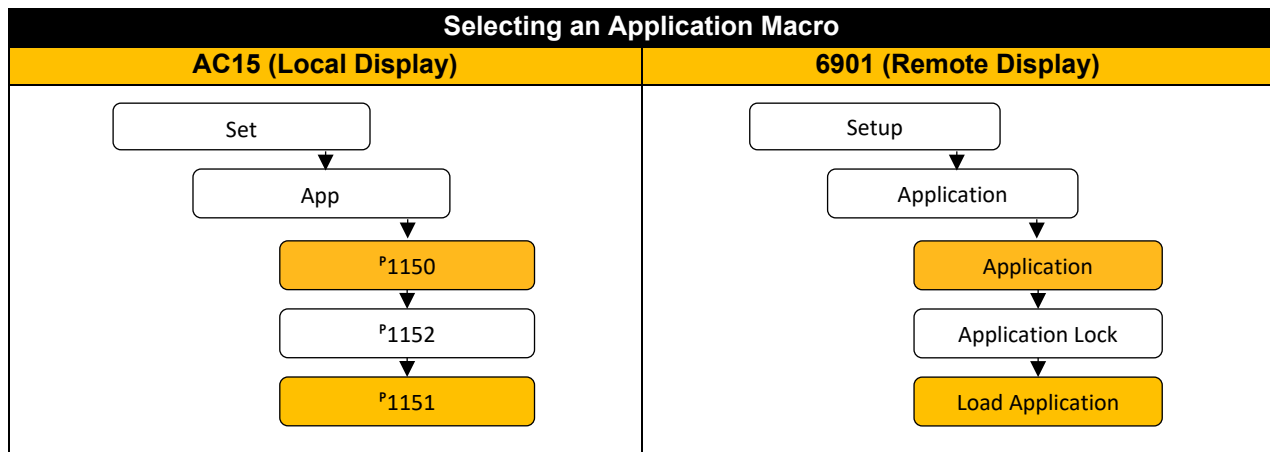

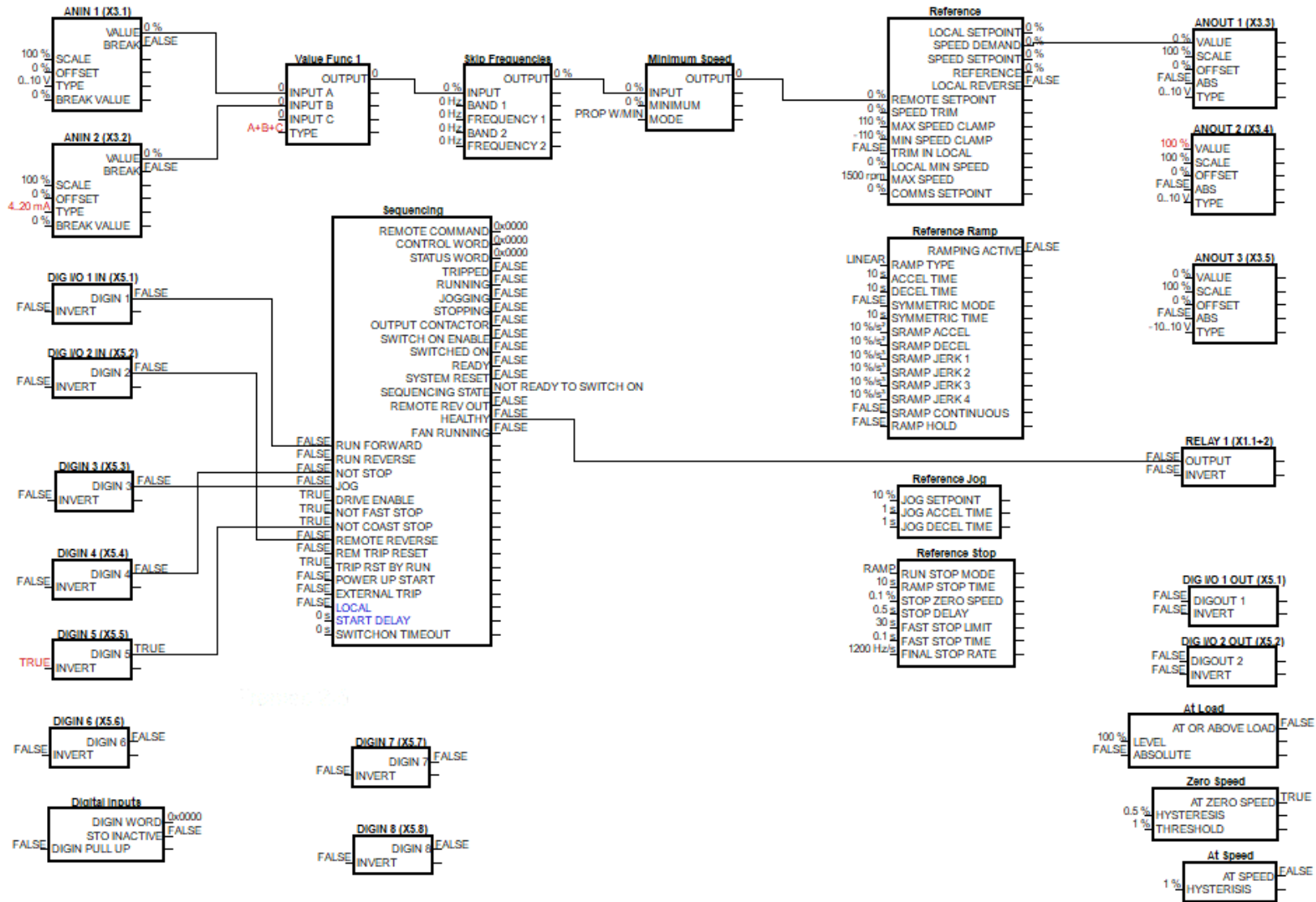

Application (Macro) 1 : Standard (Basic Speed Control)

13.4 Standard (Basic Speed Control)

This Application is ideal for general purpose applications. It provides push-button or switched start/stop control.

The Speed Setpoint is the sum of the two analogue inputs AIN1 and AIN2, providing Speed Setpoint + Speed Trim capability.

Required Terminal Connections:	
Terminal	Function
RL1A	110-230Vac (or 24Vdc) voltage supply
RL1B	Healthy: Relay output (to lamp)
TH1	Motor Thermistor '+' connection
TH2	Motor Thermistor '-' connection
AI1	Remote Setpoint (%) – input 1: 0-10V variable input (from potentiometer)
AI2	Remote Setpoint 'Trim' (%) – input 2: 4-20mA variable input (from current source)
AO1	Speed Demand (%): 0-10V variable output (to voltmeter)
AO2	Value = 100%: 0-10V variable output (+10V fixed reference voltage)
DX1	Run Forward: 24V digital input
DX2	Remote Reverse: 24V digital input
DX3	Jog: 24V digital input
DI4	Not Stop: 24V digital input
DI5	Not Coast Stop: 24V digital input
STO	STO DISABLED (drive operational)

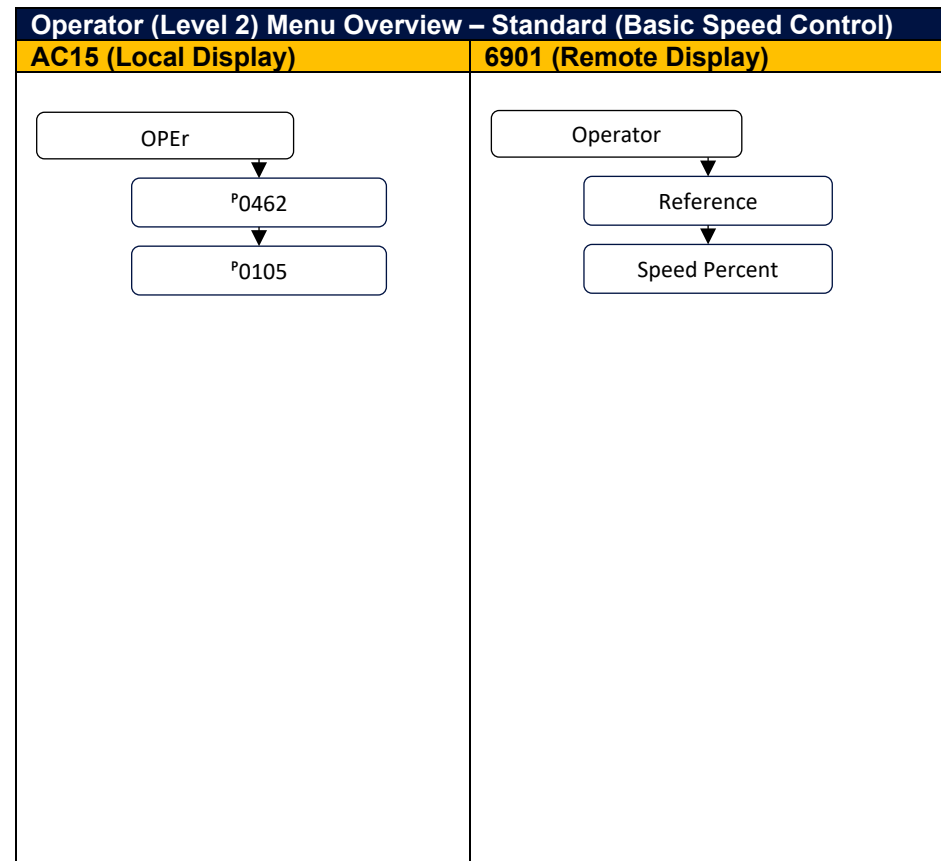

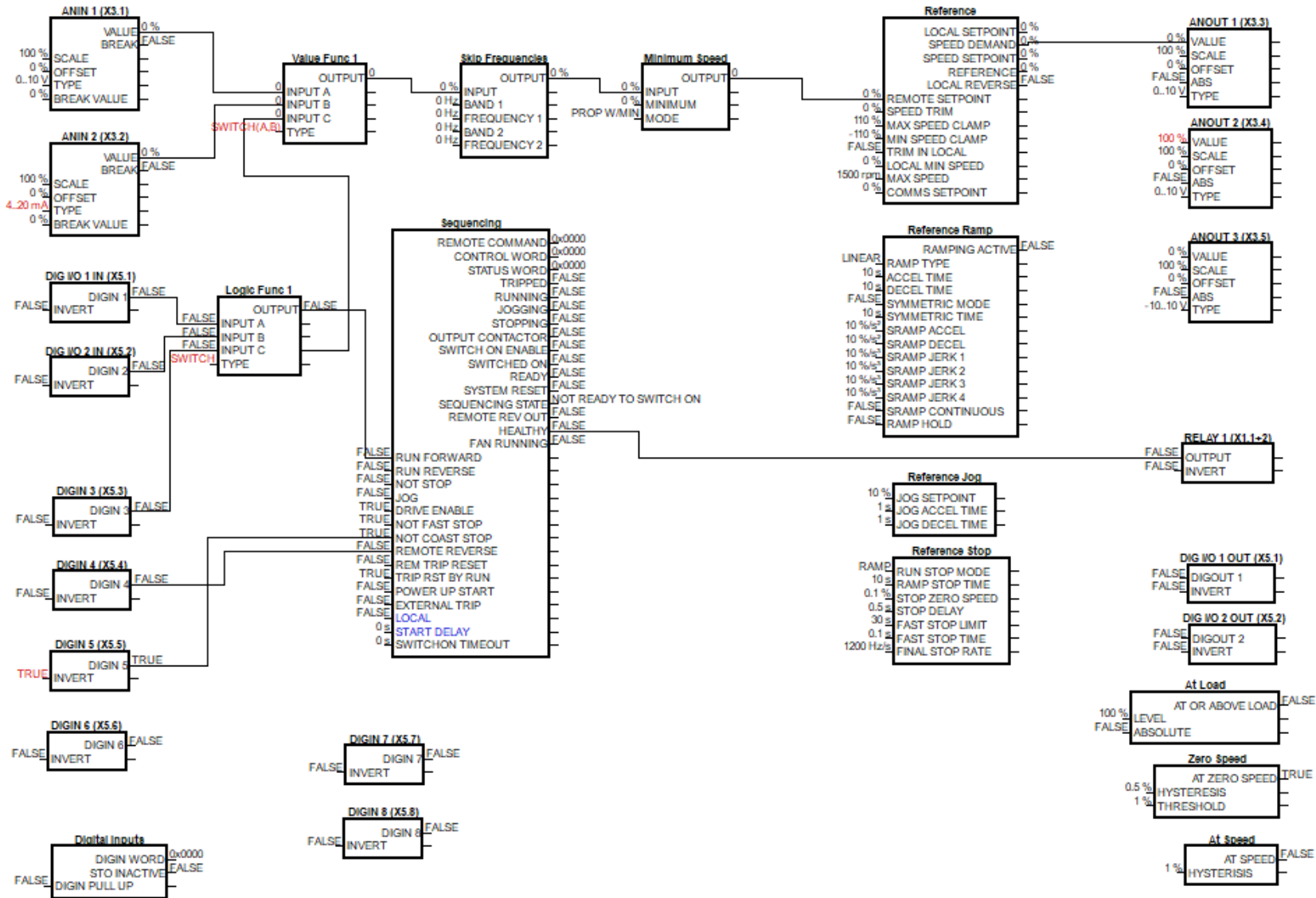

Application (Macro) 2 : Auto/Manual

13.5 Auto / Manual

Two Run inputs and two Setpoint inputs are provided.
 The Auto/Manual switch selects which pair of inputs is active.
 The Application is sometimes referred to as Local/Remote.

Required Terminal Connections:	
Terminal	Function
RL1A	110-230Vac (or 24Vdc) voltage supply
RL1B	Healthy: Relay output (to lamp)
TH1	Motor Thermistor '+' connection
TH2	Motor Thermistor '-' connection
AI1	'Manual' Remote Setpoint (%): 0-10V variable input (from potentiometer)
AI2	'Auto' Remote Setpoint (%): 4-20mA variable input (from current source)
AO1	Speed Demand (%): 0-10V variable output (to voltmeter)
AO2	Value = 100%: 0-10V variable output (+10V fixed reference voltage)
DX1	'Manual' Run: 24V digital input
DX2	'Auto' Run: 24V digital input
DX3	Auto / Manual Select: 24V digital input
DI4	Remote Reverse: 24V digital input
DI5	Not Coast Stop: 24V digital input
STO	STO DISABLED (drive operational)

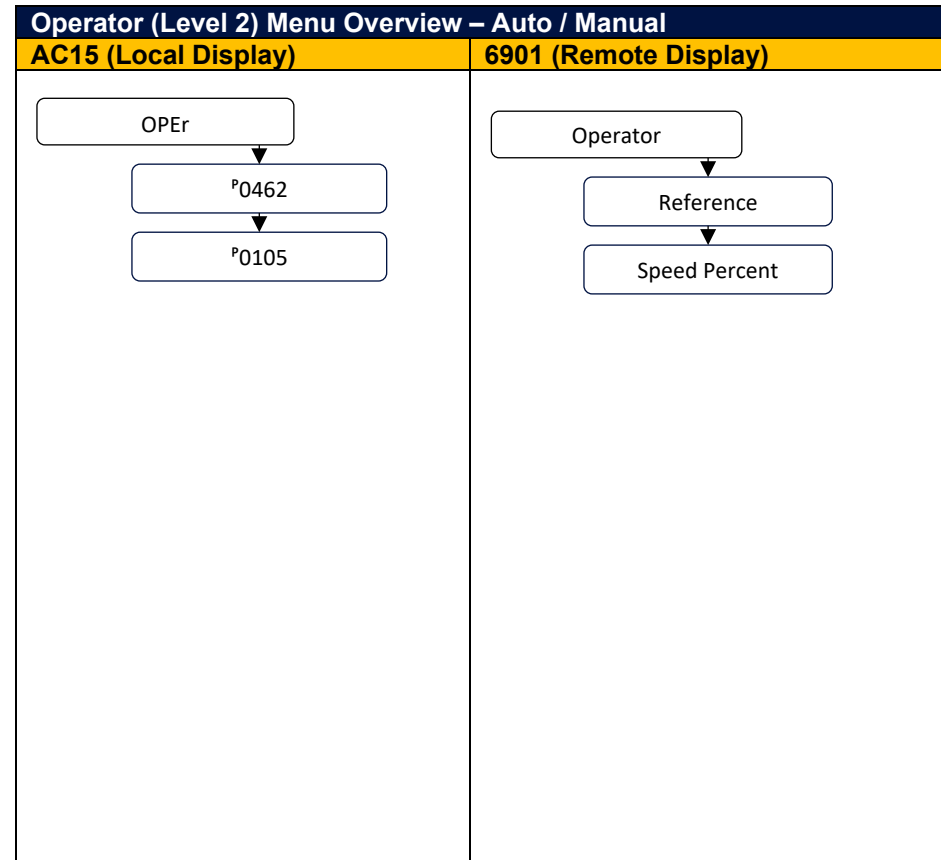

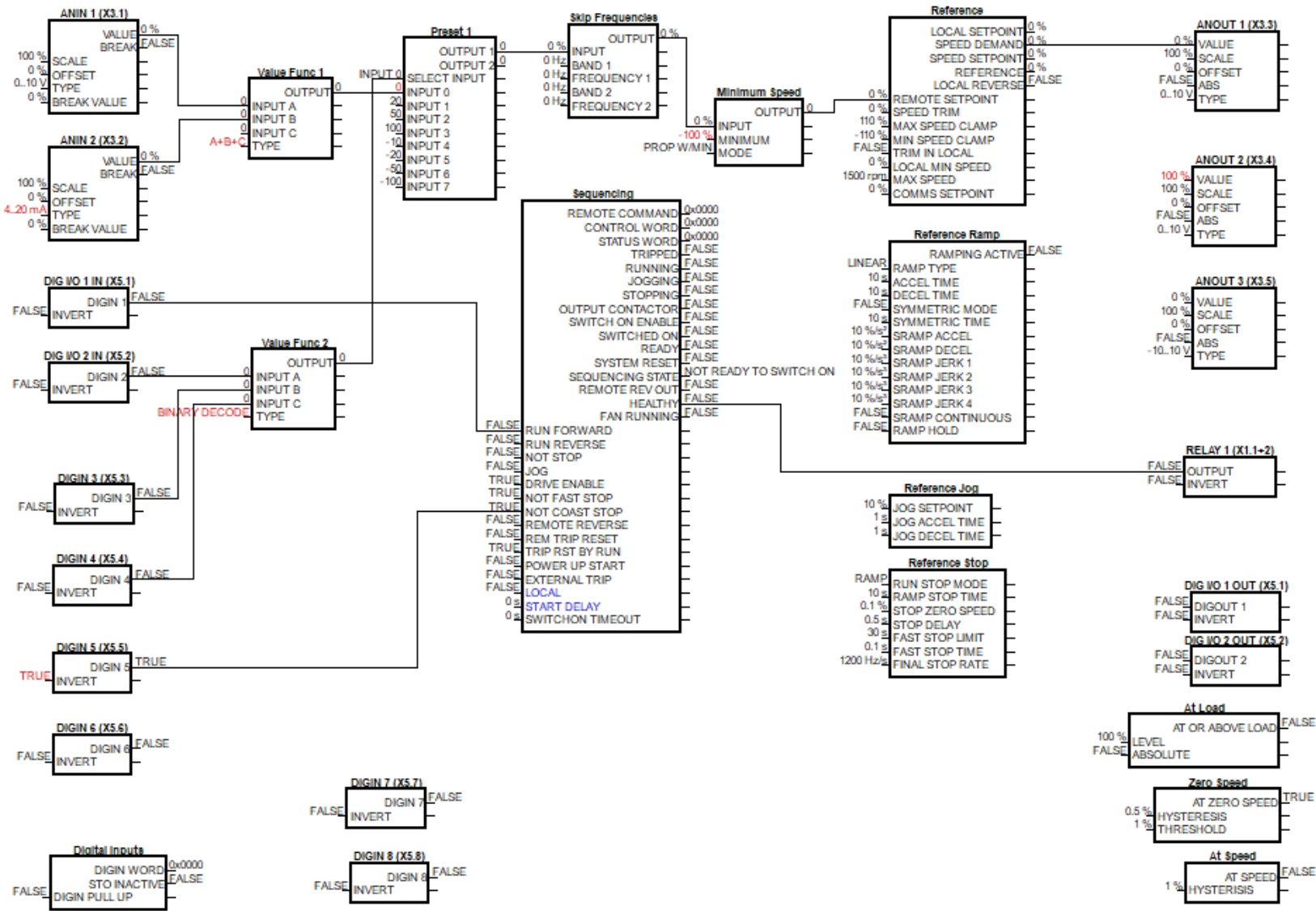

Application (Macro) 3 : Presets

13.6 Presets

This macro is ideal for applications requiring multiple discrete speed levels.

The setpoint is selected from either the sum of the analogue inputs, (Preset 0), or from one of up to seven other pre-defined speed levels. These are selected using DIN2, DIN3 and DIN4, as shown in the table below.

Edit the speed setpoint percentage parameters 1942 to 1948 at the inputs of the Preset function block to re-define the speed levels of Preset 1 to Preset 7. Reverse direction is achieved by entering a negative speed setpoint.

Required Terminal Connections:	
Terminal	Function
RL1A	110-230Vac (or 24Vdc) voltage supply
RL1B	Healthy: Relay output (to lamp)
TH1	Motor Thermistor '+' connection
TH2	Motor Thermistor '-' connection
AI1	Remote Setpoint (%) – input 1: 0-10V variable input (from potentiometer)
AI2	Remote Setpoint 'Trim' (%) – input 2: 4-20mA variable input (from current source)
AO1	Speed Demand (%): 0-10V variable output (to voltmeter)
AO2	Value = 100%: 0-10V variable output (+10V fixed reference voltage)
DX1	Run Forward: 24V digital input
DX2	Preset Select 1: 24V digital input
DX3	Preset Select 2: 24V digital input
DI4	Preset Select 3: 24V digital input
DI5	Not Coast Stop: 24V digital input
STO	STO DISABLED (drive operational)

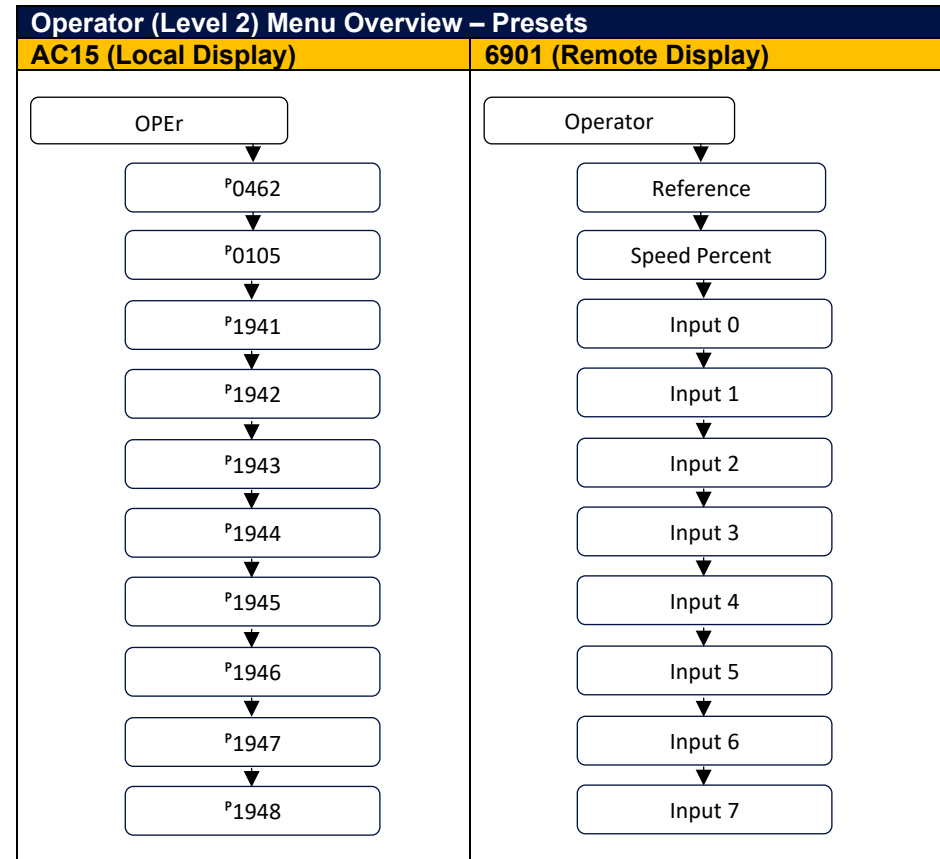

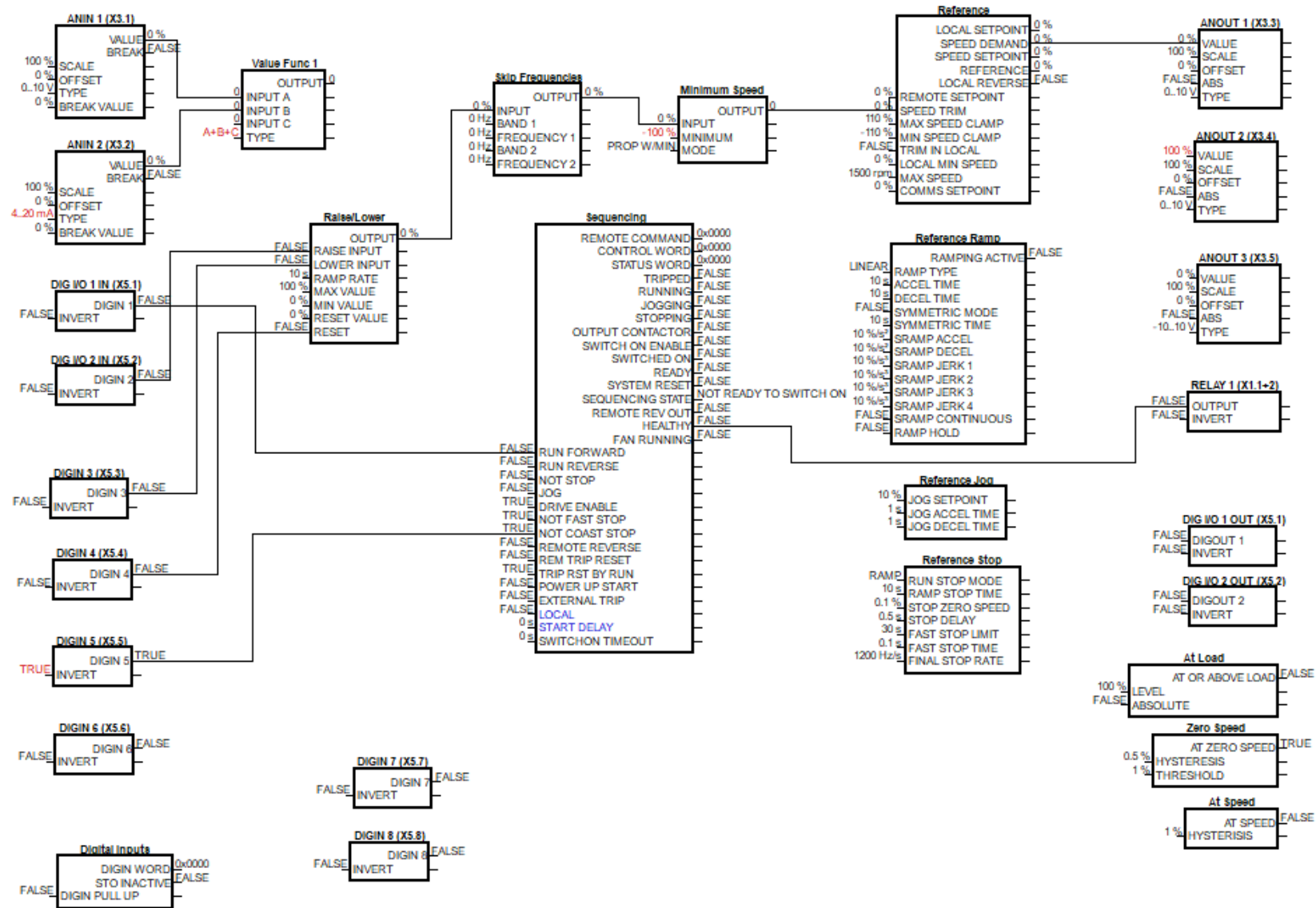

Application (Macro) 4 : Raise/Lower

13.7 Raise/Lower

This Application mimics the operation of a motorized potentiometer. Digital inputs allow the setpoint to be increased and decreased between limits. The limits and ramp rate can be set in the template.

Required Terminal Connections:	
Terminal	Function
RL1A	110-230Vac (or 24Vdc) voltage supply
RL1B	Healthy: Relay output (to lamp)
TH1	Motor Thermistor '+' connection
TH2	Motor Thermistor '-' connection
AO1	Speed Demand (%): 0-10V variable output (to voltmeter)
DX1	Run Forward: 24V digital input
DX2	Raise: 24V digital input
DX3	Lower: 24V digital input
DI4	Raise / Lower Reset: 24V digital input
DI5	Not Coast Stop: 24V digital input
STO	STO DISABLED (drive operational)

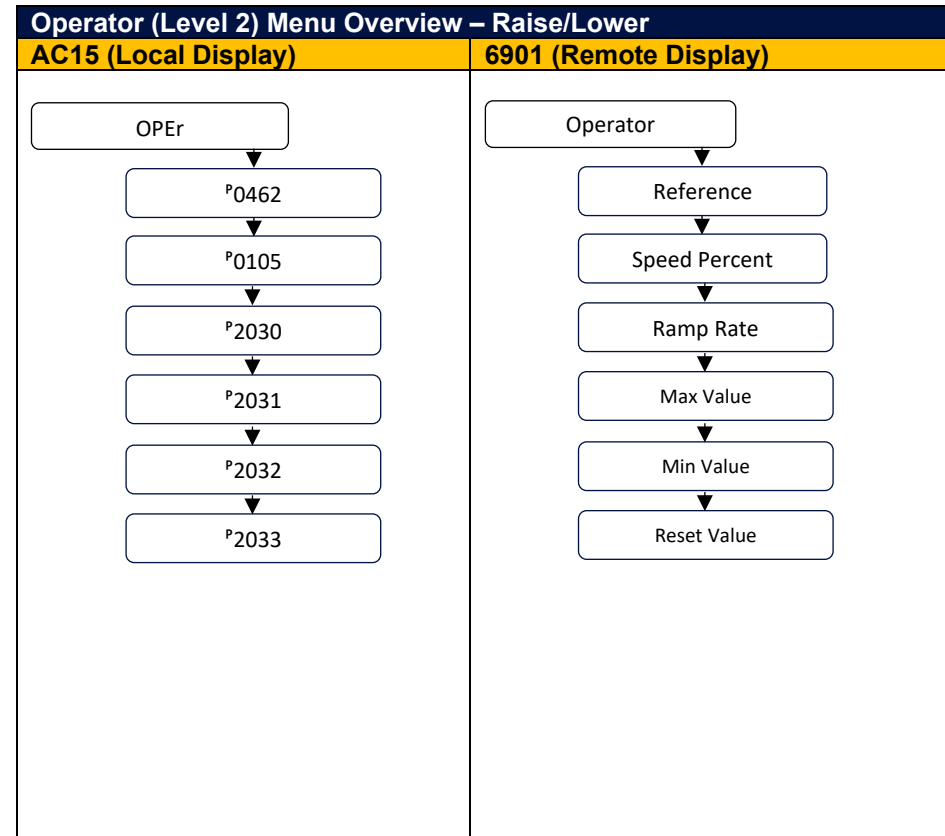

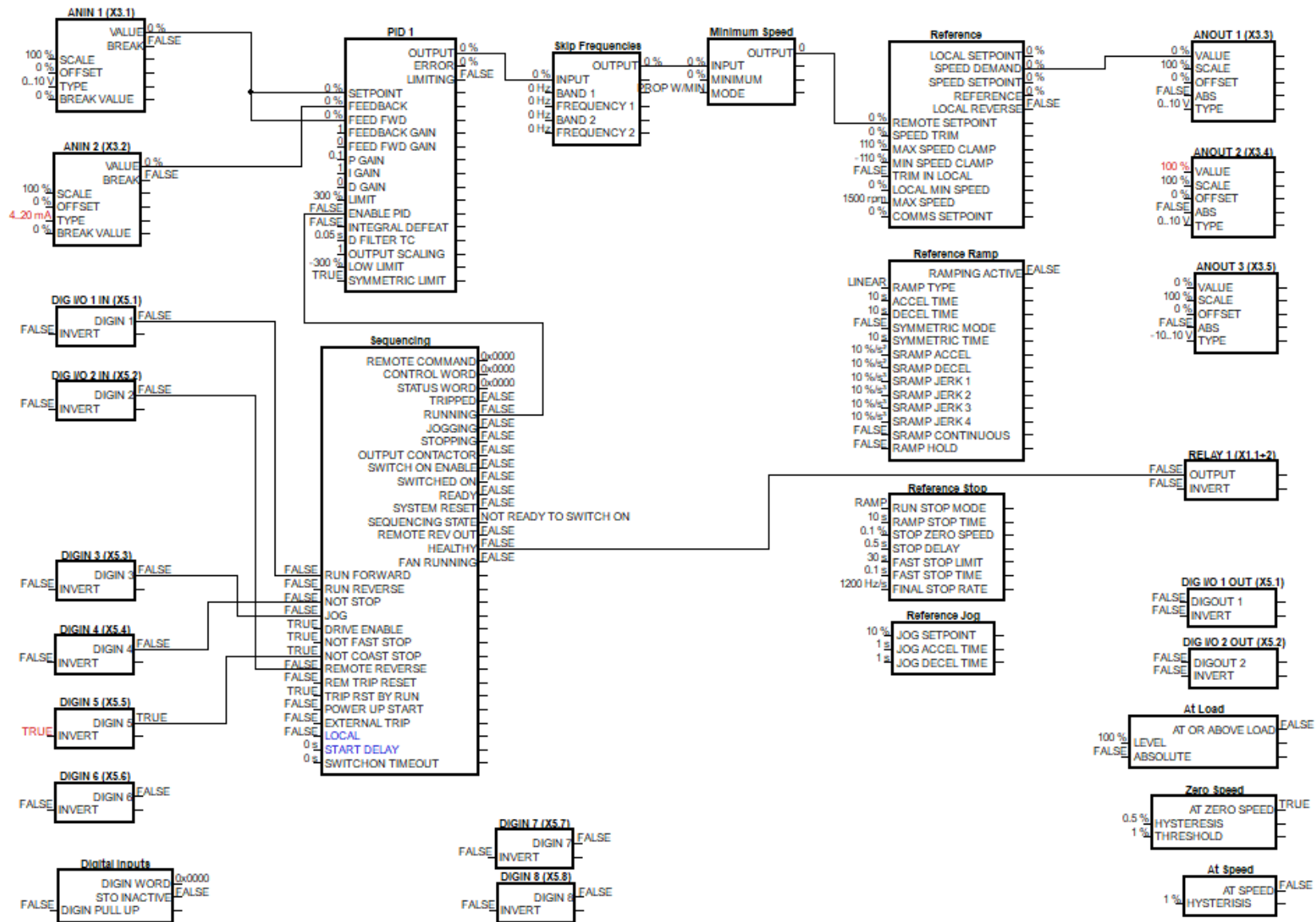

Application (Macro) 5 : PID

13.8 PID

A simple application using a Proportional-Integral-Derivative 3-term controller. The setpoint is taken from AIN1, with feedback signal from the process on AIN2. The scale and offset features of the analogue input blocks may be used to correctly scale these signals. The difference between these two signals is taken as the PID error. The output of the PID block is then used as the drive setpoint.

Required Terminal Connections:	
Terminal	Function
RL1A	110-230Vac (or 24Vdc) voltage supply
RL1B	Healthy: Relay output (to lamp)
TH1	Motor Thermistor '+' connection
TH2	Motor Thermistor '-' connection
AI1	Process Setpoint (%) – input 1: 0-10V variable input (from potentiometer)
AI2	Process Feedback (%) – input 2: 4-20mA variable input (from current source)
AO1	Speed Demand (%): 0-10V variable output (to voltmeter)
AO2	Value = 100%: 0-10V variable output (+10V fixed reference voltage)
DX1	Run Forward: 24V digital input
DX2	Remote Reverse: 24V digital input
DX3	Jog: 24V digital input
DI4	Not Stop: 24V digital input
DI5	Not Coast Stop: 24V digital input
STO	STO DISABLED (drive operational)

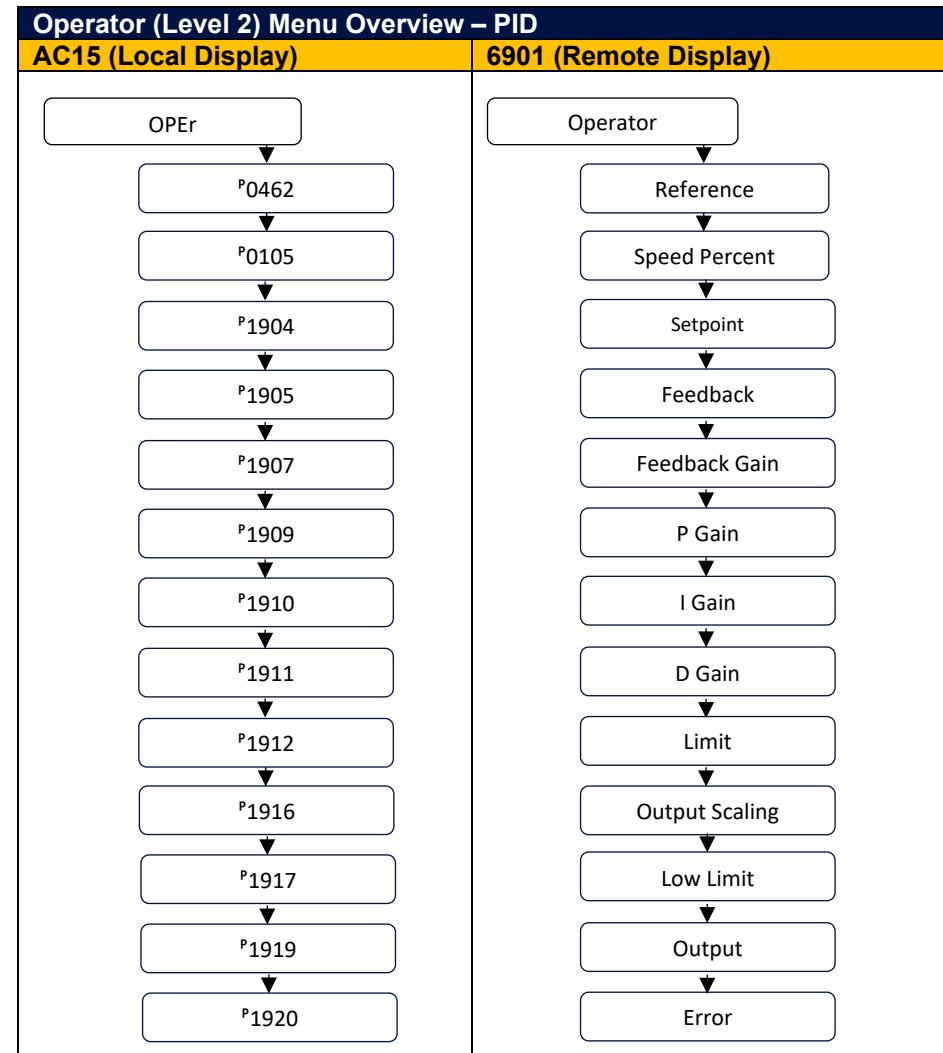

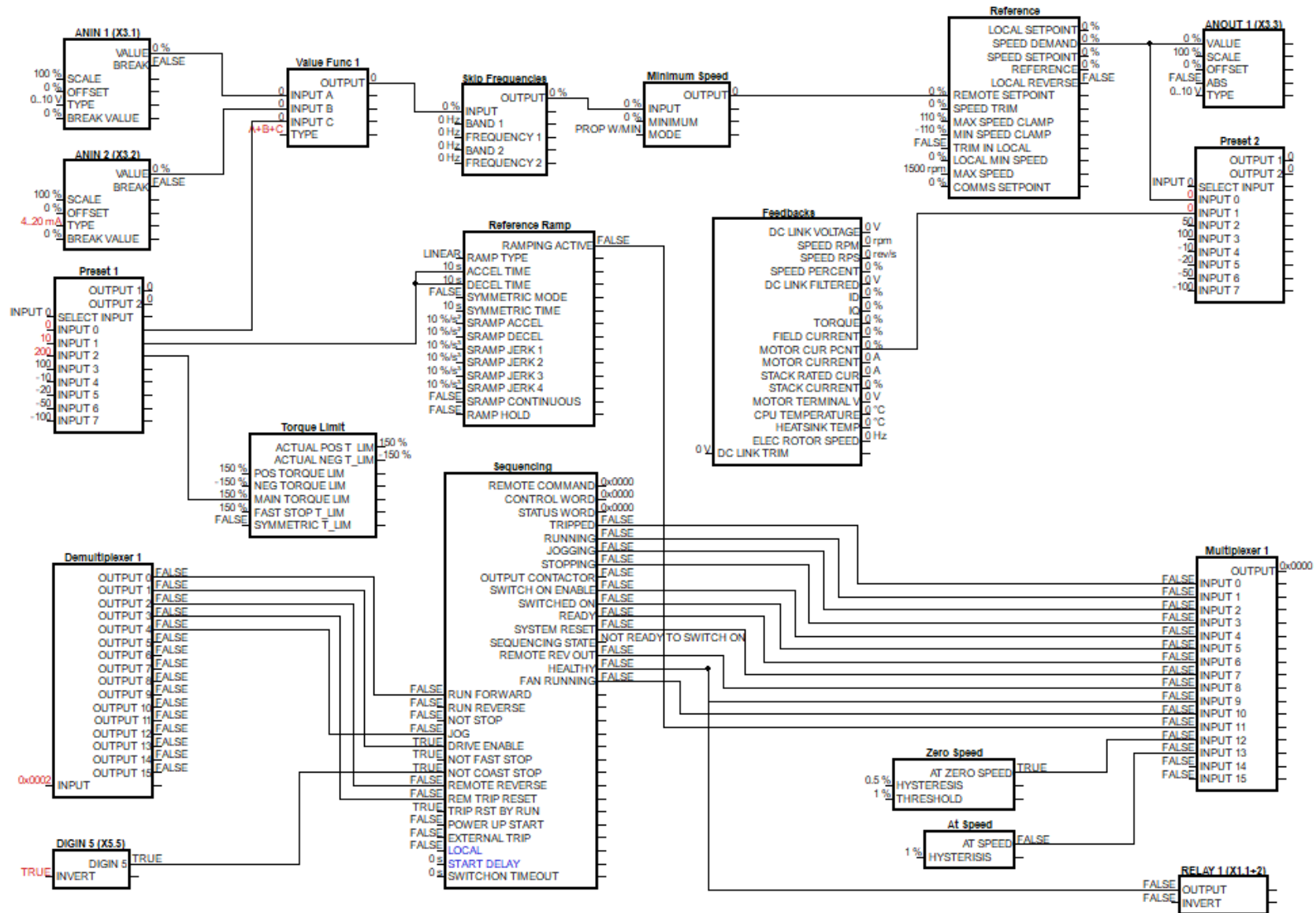

Application (Macro) 6 : Aux Comms

13.9 Aux Comms

Aux Comms is designed to reproduce the Aux Comms macro/template from the legacy 650 range of drives. The default method of communications for this macro is Modbus TCPIP, and the master controller must be configured with a mapping that connects to the points shown in red text within the template. Refer to the instructions on configuring base Modbus TCPIP communications for more information.

Required Terminal Connections:	
Terminal	Function
RL1A	110-230Vac (or 24Vdc) voltage supply
RL1B	Healthy: Relay output (to lamp)
TH1	Motor Thermistor '+' connection
TH2	Motor Thermistor '-' connection
AI1	Remote Setpoint (%) – input 1: 0-10V variable input (from potentiometer)
AI2	Remote Setpoint 'Trim' (%) – input 2: 4-20mA variable input (from current source)
AO1	Speed Demand (%): 0-10V variable output (to voltmeter)
AO2	Value = 100%: 0-10V variable output (+10V fixed reference voltage)
DI5	Not Coast Stop: 24V digital input
STO	STO DISABLED (drive operational)

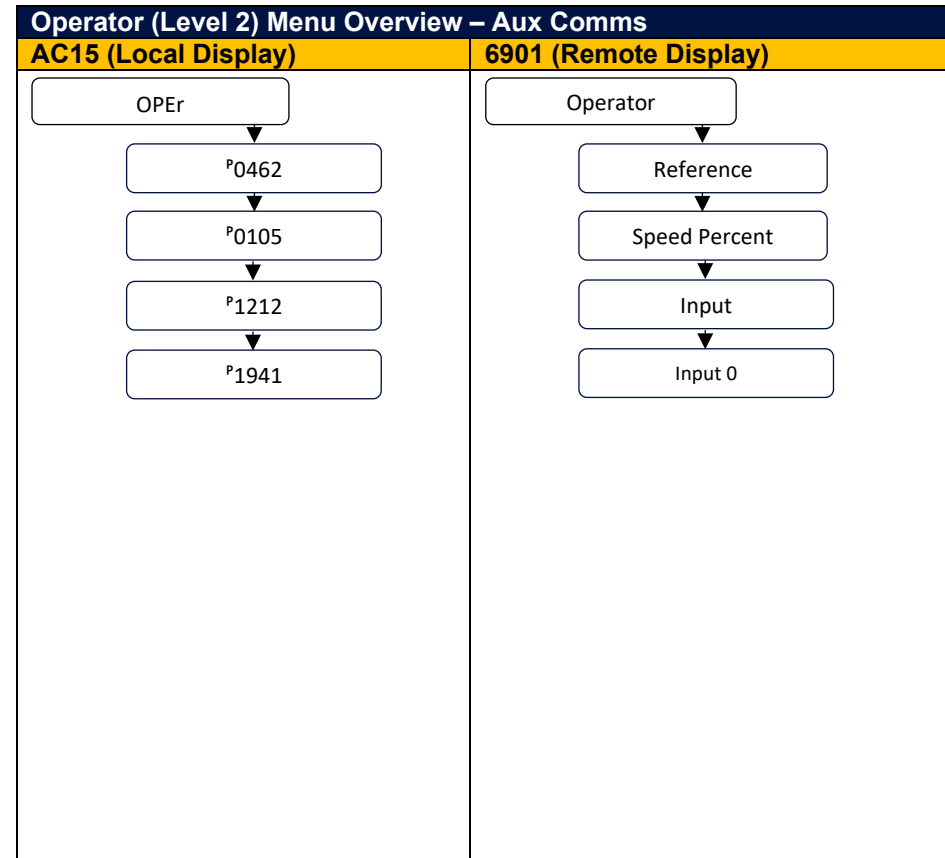



EMAC s.r.o.
Kasarenska 2404/26
911 05 Trencin
SLOVAKIA

Parker certified distributor
☎ +421 32 3810 232
✉ info@emac.sk
🌐 www.emac.sk